

HMD-V200

SERVICE MANUAL

US Model
Canadian Model

Chassis No. SCC-L28B-A

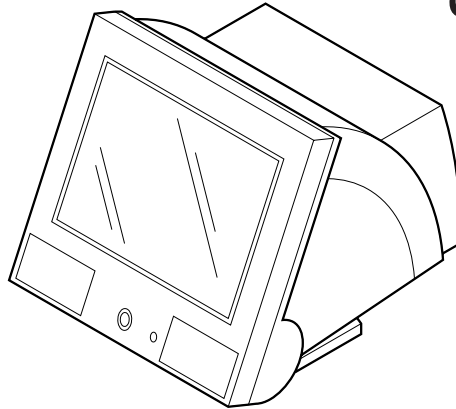

HIT CHASSIS

(1) Schematic Diagram of A (a), (b) Board

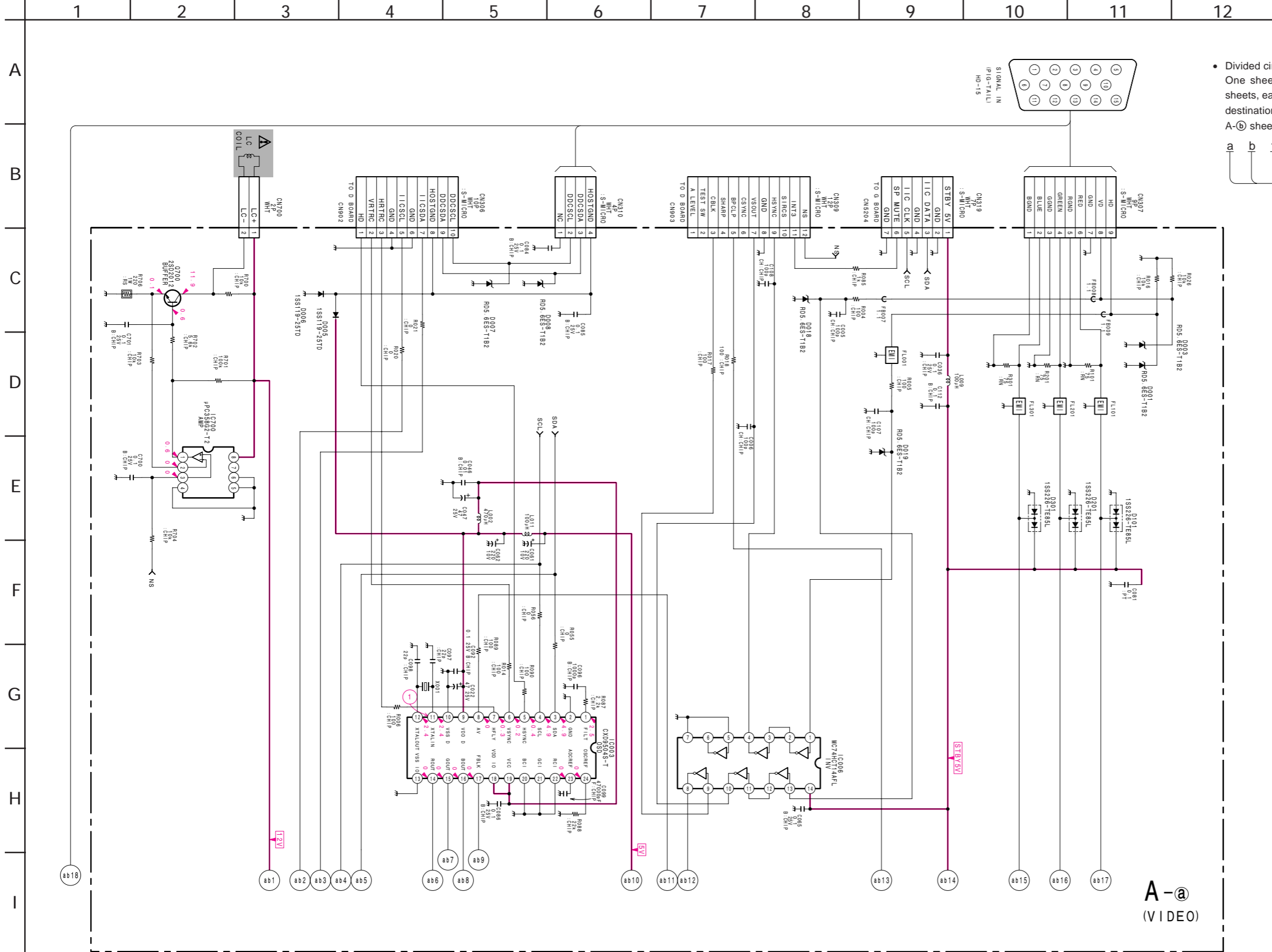

• Divided circuit diagram
 One sheet of A board circuit diagram is divided into two sheets, each having the code A-ⓐ to A-ⓑ. For example, the destination (ⓑ1) on the A-ⓐ sheet is connected to (ⓐ1) on the A-ⓑ sheet.

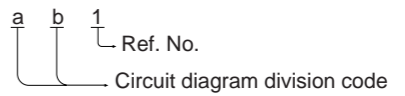

• A - ⓐ BOARD WAVEFORM

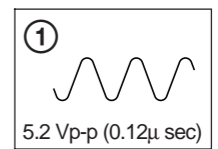

Schematic diagram
 A - ⓐ board →

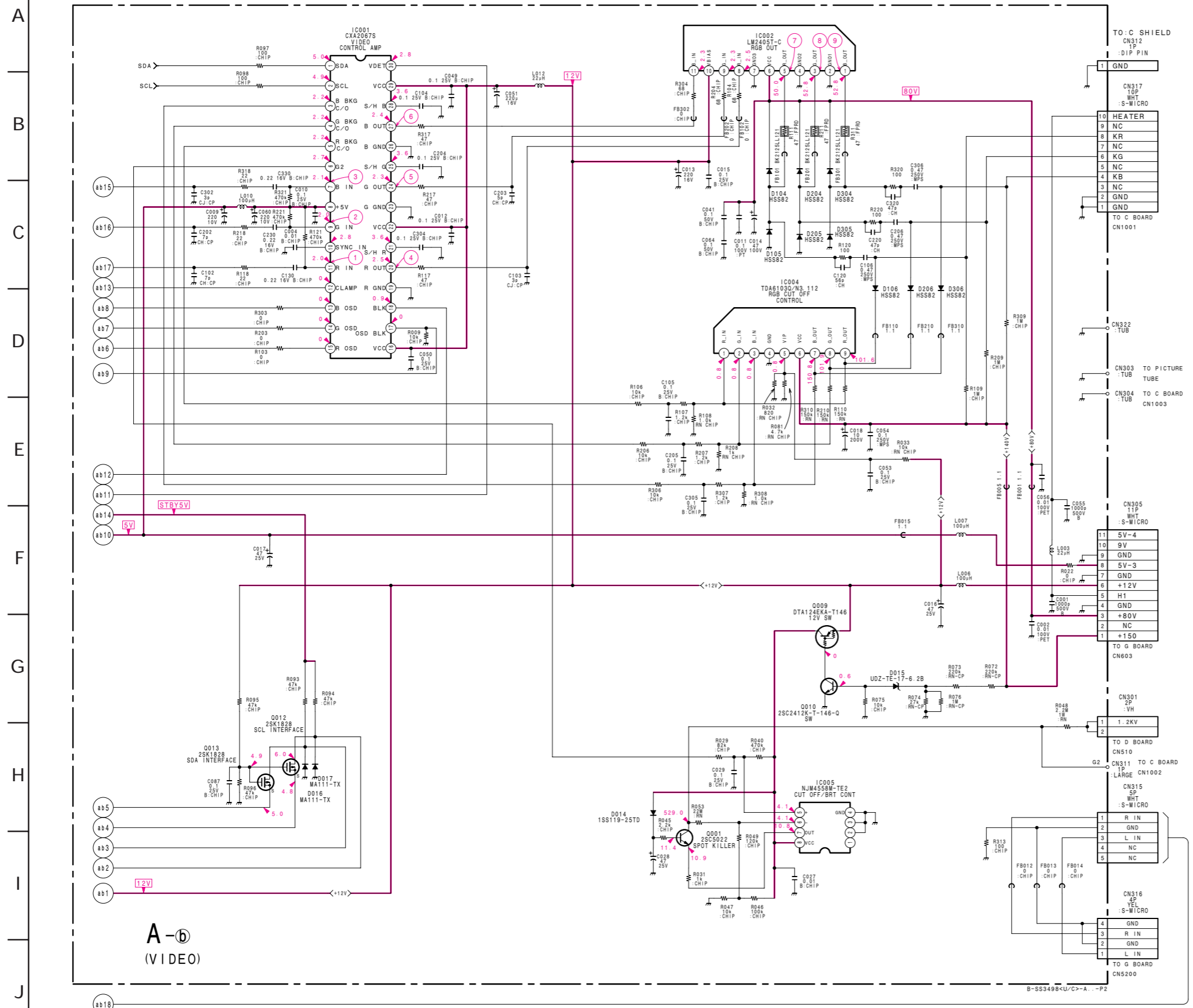

• Divided circuit diagram
 One sheet of A board circuit diagram is divided into two sheets, each having the code A-ⓐ to A-ⓑ. For example, the destination (ab1) on the A-ⓐ sheet is connected to (ab1) on the A-ⓑ sheet.

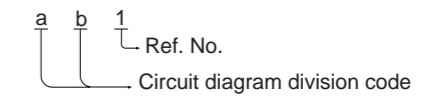

• A - ⓐ BOARD WAVEFORMS

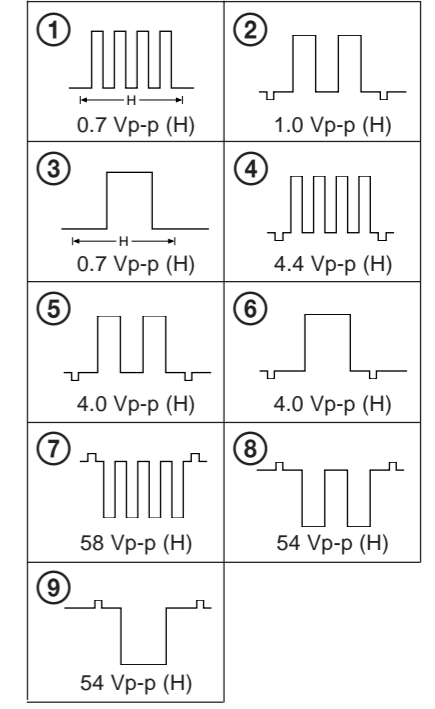

A-ⓑ
 (VIDEO)

(2) Schematic Diagram of D (a, b) Board

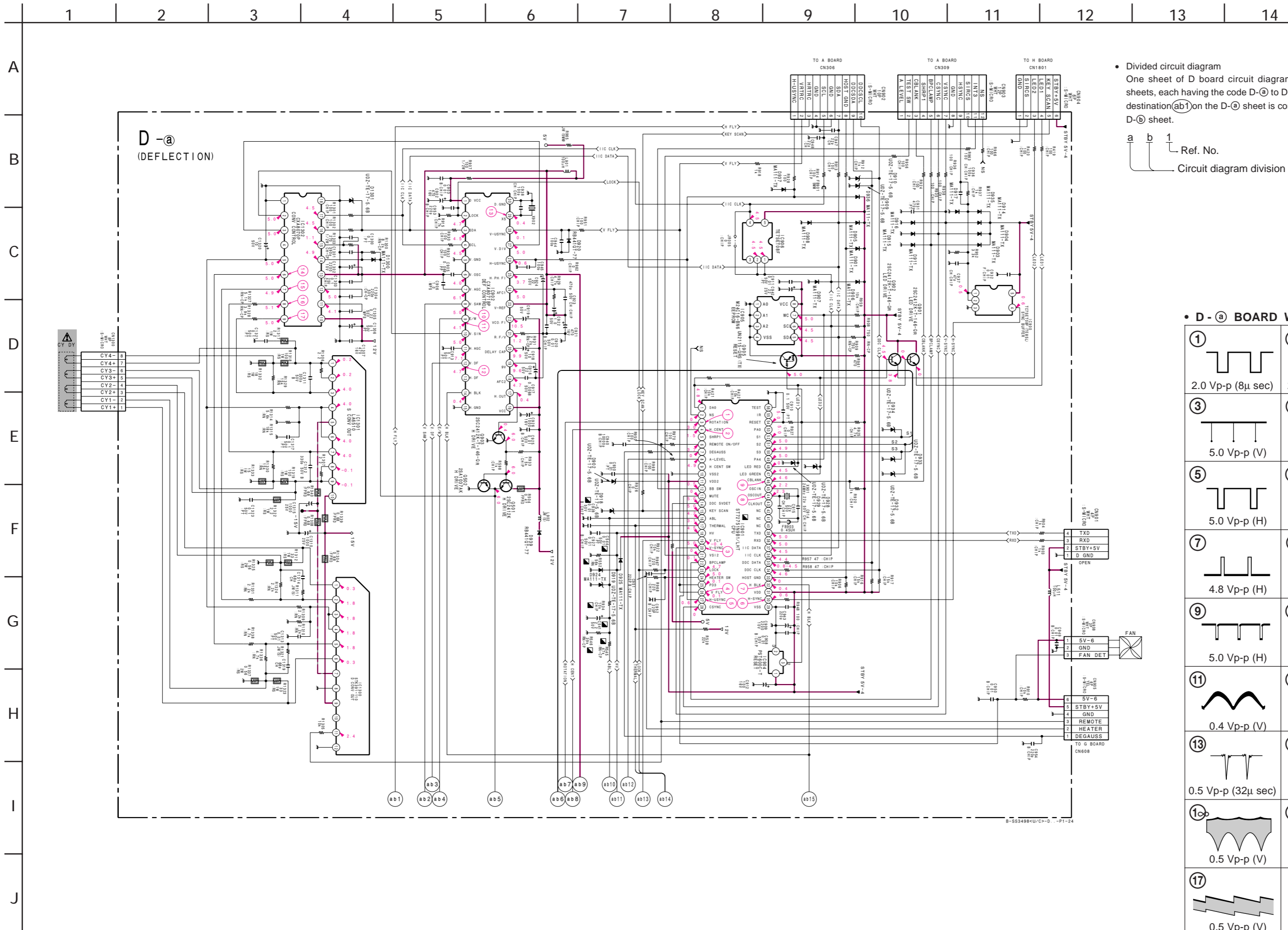

• Divided circuit diagram
 One sheet of D board circuit diagram is divided into two sheets, each having the code D-ⓐ to D-ⓑ . For example, the destination ⓐ1 on the D-ⓐ sheet is connected to ⓐ1 on the D-ⓑ sheet.

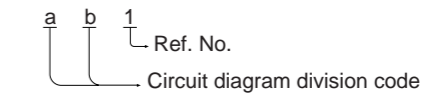

• D - ⓐ BOARD WAVEFORMS

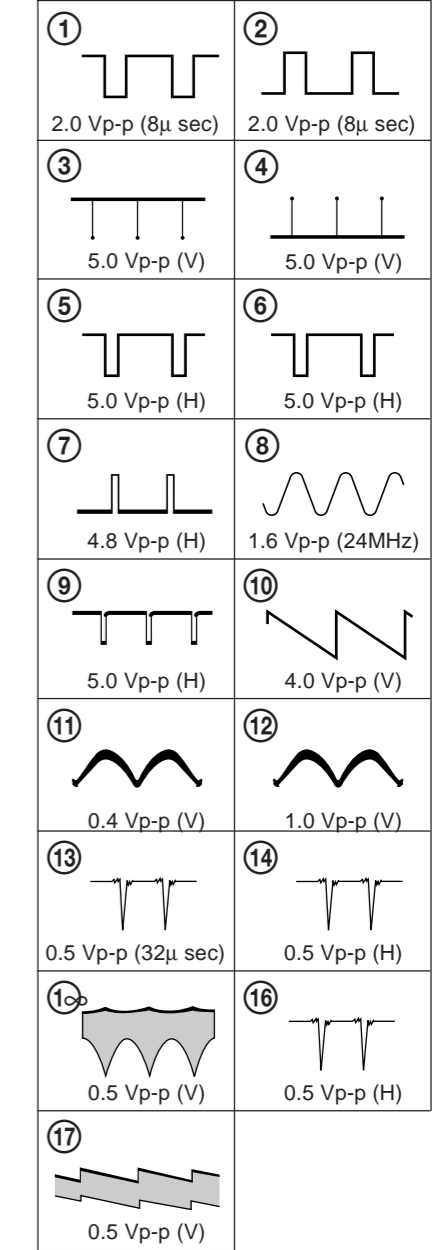

Schematic diagram
 D - ⓐ board →

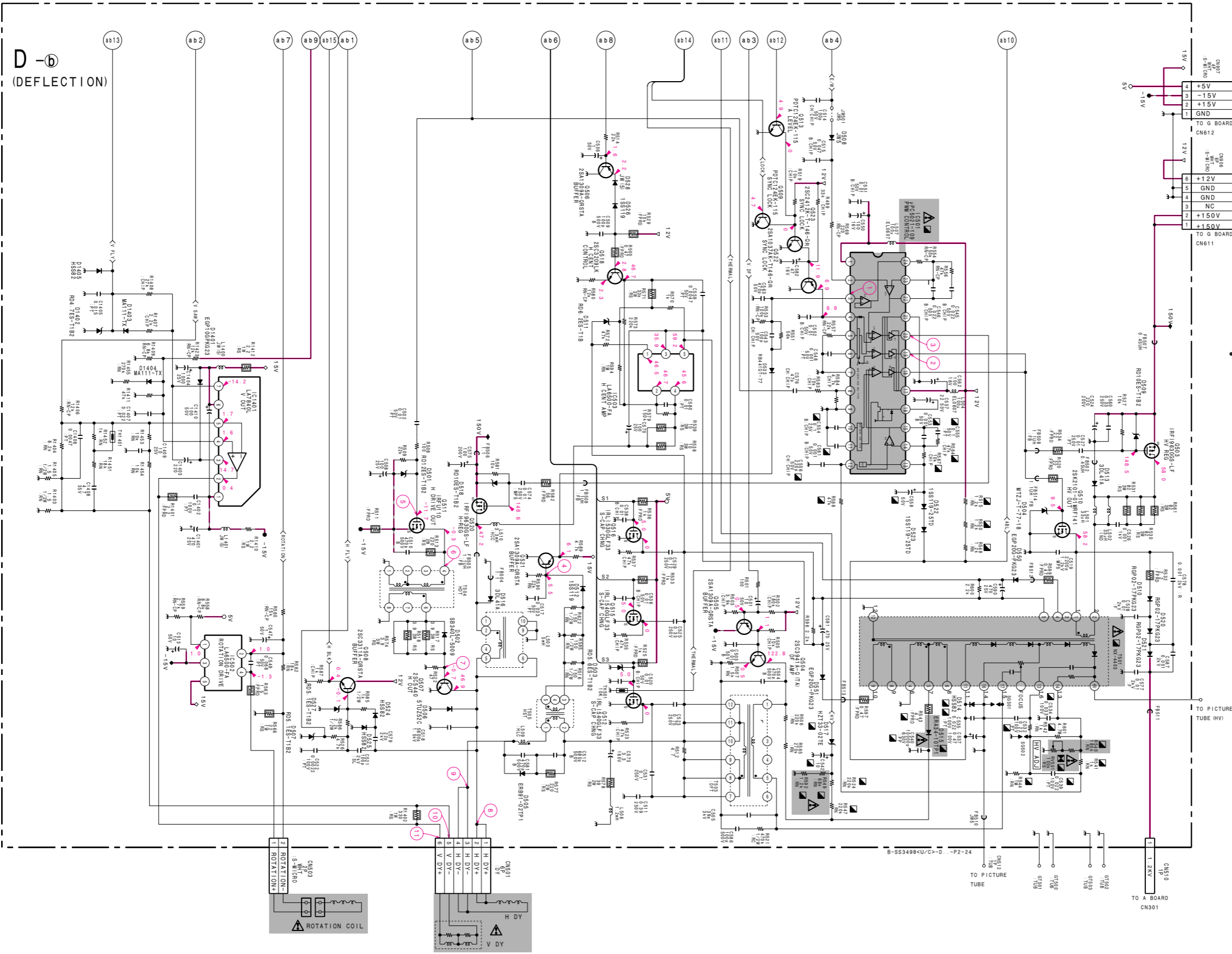

• Divided circuit diagram
 One sheet of D board circuit diagram is divided into two sheets, each having the code D-ⓐ to D-ⓑ . For example, the destination (ab1) on the D-ⓐ sheet is connected to (ab1) on the D-ⓑ sheet.

Ref. No.
 a b 1

Circuit diagram division code

• D - ⓑ BOARD WAVEFORMS

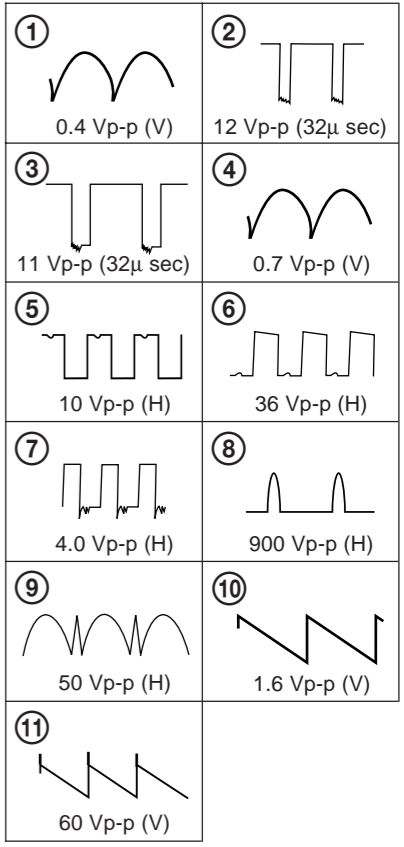

(3) Schematic Diagrams of C, H, J and M Boards

1 2 3 4 5 6 7 8 9 10 11 12 13 14

A
B
C
D
E
F
G
H
I
J

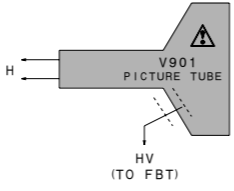
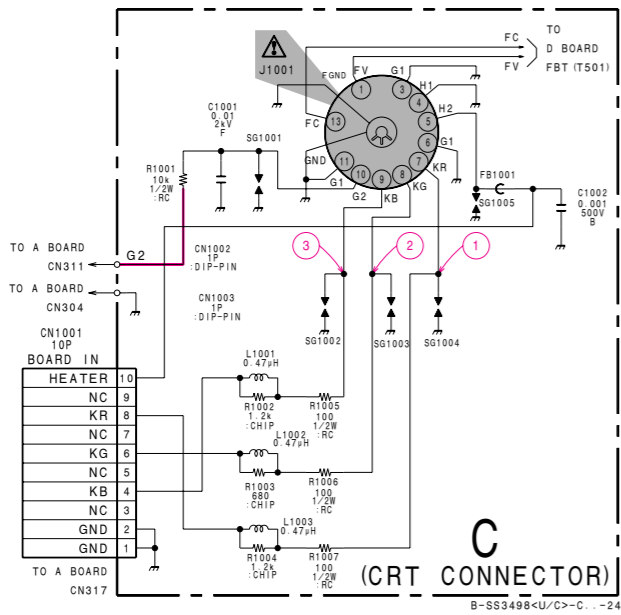

• C BOARD WAVEFORMS

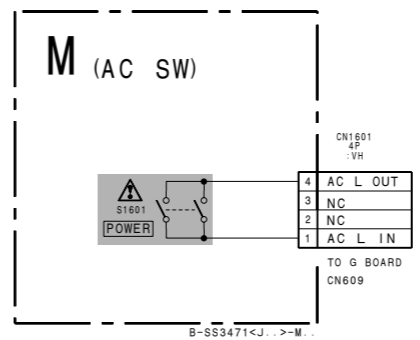
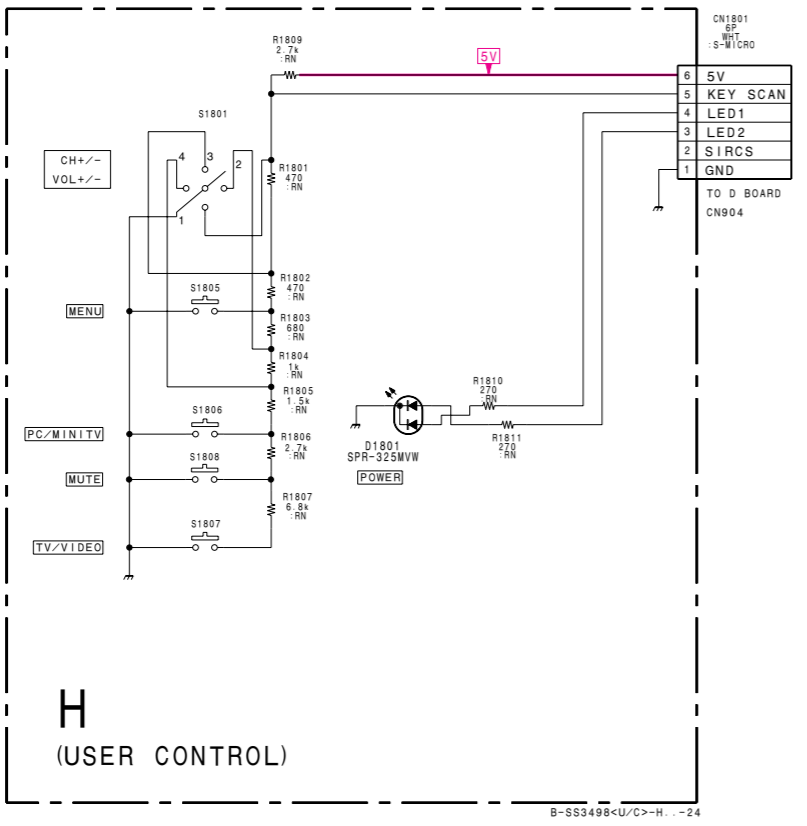
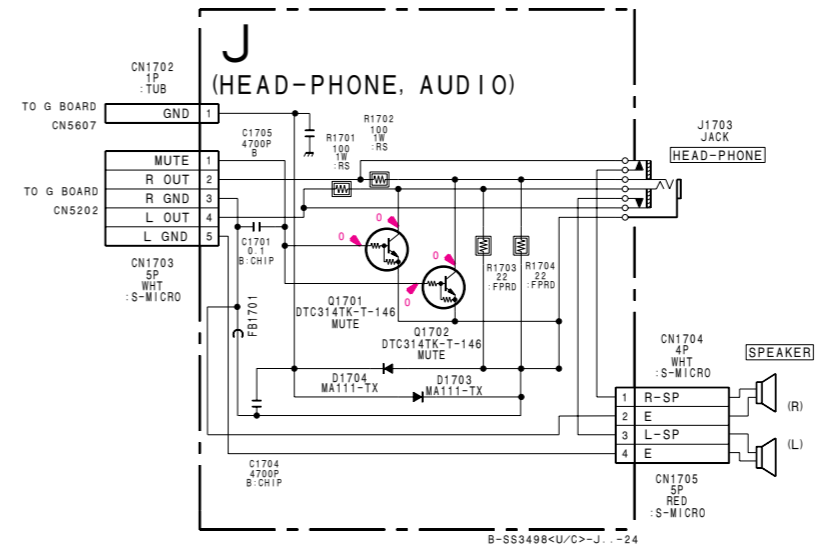
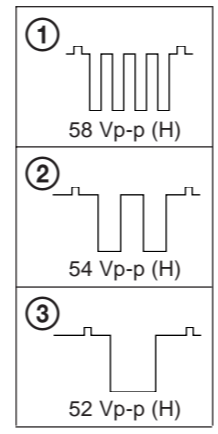

(4) Schematic Diagrams of G (a, b) Boards

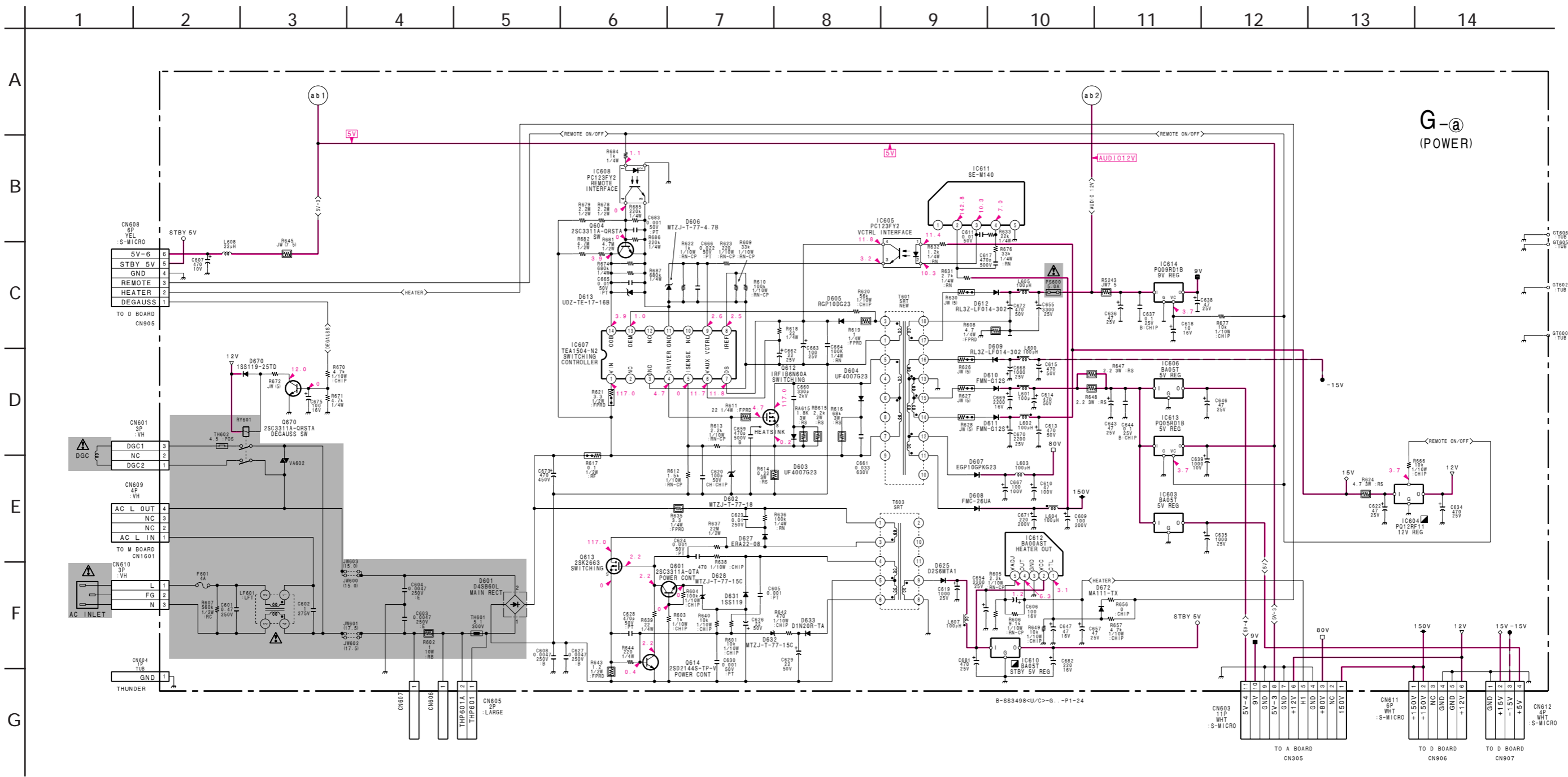

- Divided circuit diagram
One sheet of G board circuit diagram is divided into two sheets, each having the code G-a to G-b. For example, the destination (ab1) on the G-a sheet is connected to (ab1) on the G-b sheet.

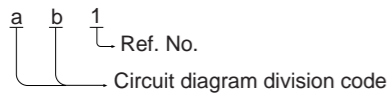

Schematic diagram

G-a board →

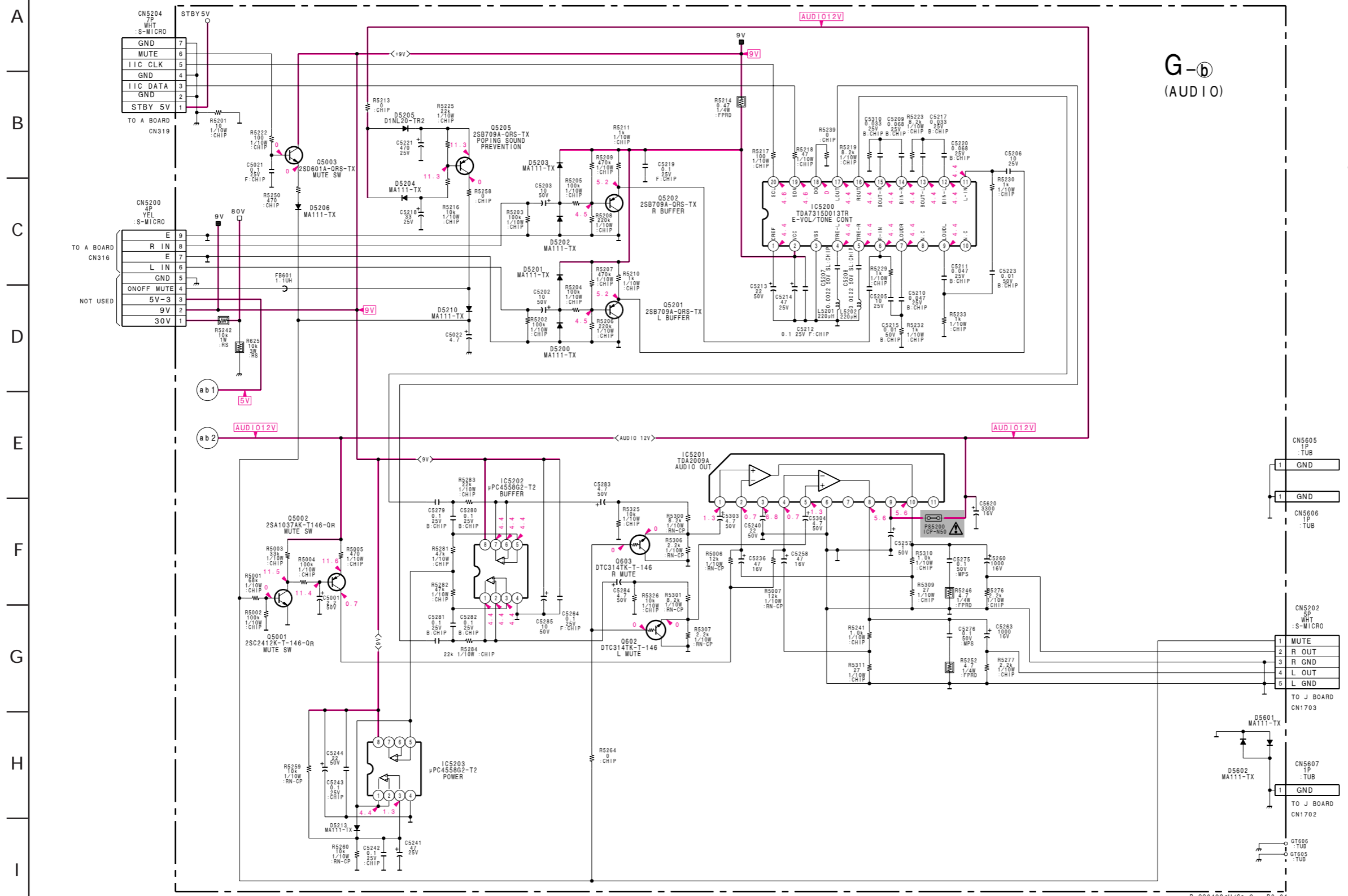

G-a
(AUDIO)

• Divided circuit diagram
 One sheet of G board circuit diagram is divided into two sheets, each having the code G-a to G-b. For example, the destination (ab1) on the G-a sheet is connected to (ab1) on the G-b sheet.

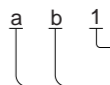

 Ref. No.
 Circuit diagram division code

5-5. SEMICONDUCTORS

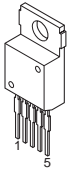
BA00AST
LA6500FA

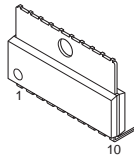

LA6510



PQ12RF11

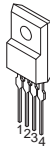

TDA6103Q/N3,112

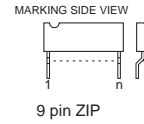

DTA114TK
DTA124EKA-T146
DTC144EKA-T146
DTC314TKH04
DTC314TK-T-146
PDTC124EK-115
UN2115-QRS
2SA1037AK-T146-R
2SA1037K-T-146-QR
2SA1162G
2SB709A-QRS-TX
2SC1623-L5L6
2SC2412K-T-146-Q
2SC2412K-T-146-QR
2SD601A-Q
2SD601A-QRS-TX

BA05T

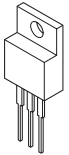

LA7840L

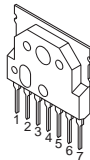

PST600C-T

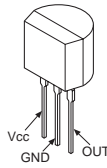

TDA7315D013TR

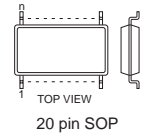

BA10358F
NJM4558M
UPC358G2
UPC4558G2

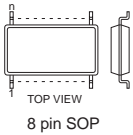

LM2405T

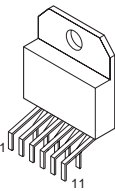

STK391-110

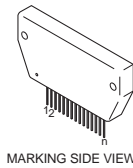

TEA1504-N2

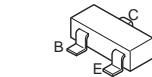
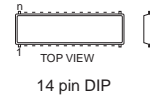

IRFI9630GS
IRFI9630GS-LF

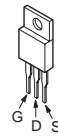

UPC5021-109

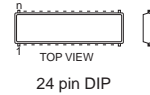

CXA2067S
CXA8071BP

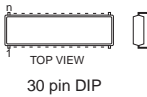

MC74HCT14AFL

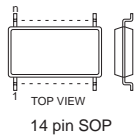

ST72751N9B1/LHT

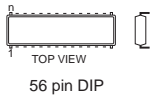

UPC574J

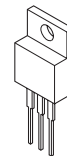

IRFU110
IRFU110A

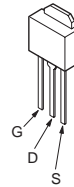

CXA8070P

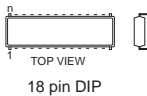

M24C16-BN6

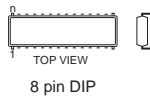

TC7SET08F

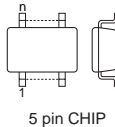

IRLI530GLF33



CXD9504S

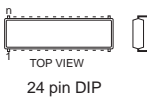

PQ05RD1B
PQ09RD1B

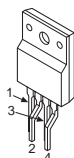

TDA2009A

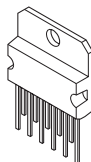

IRLI540GLF33

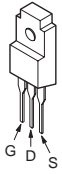

2SD2144S-V

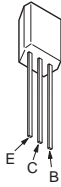

DTZ-TT11-16B
MA111
RD5.6S-B
UDZ-TE-17-16B
UDZ-TE-17-5.6B
UDZ-TE-17-6.2B

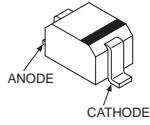

D2S6M
UF4007G23

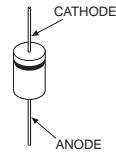

SB340L-5009

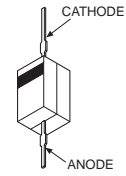

2SA1175-HFE
2SA1309A-QRSTA
2SC2785-HFE
2SC3311A-QRSTA
2SC3311A-QTA

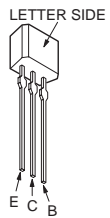

2SK1828

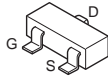

2DK2101-01MR-F141

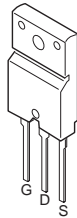

D1NL20
EGP20G
ERA22-08
ERB91-02
HSS82
HZT33-02TE
RGP02-17EL-6433
RGP02-17PKG23
RGP10DG23
RL3Z-LF014-302
UF400SPKG23
3DL41A

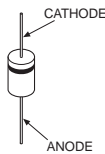

D4SB60L

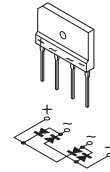

1SS226

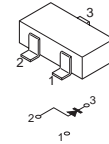

SPR-325MVW

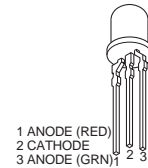

2SC3209LK

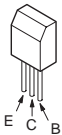

EGP10D
RH-1A

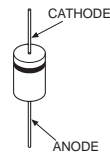

FMC-26US
FMN-G12S

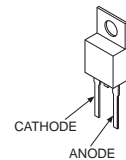

2SC3941A-Q

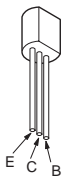

D1N20R
EGP10GPKG23
MTZJ-T-77-15C
MTZJ-T-77-18
MTZJ-T-77-4.7B
MTZJ-4.7C
RB441QT-77
RD10ES-B2
RD12ES-B2
RD15ES-B3
RD18ES-B2
RD4.7ES-B2
RD5.1ES-B2
RD5.6ES-B2
RD6.2ES-B2
1SS119-25

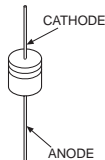

FMQ-G5FMS
5TUZ52C

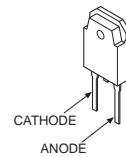

2SC5022-02
2SD2012

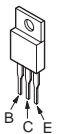

PC123F2
PC123FY2

