

PTSW22A0X

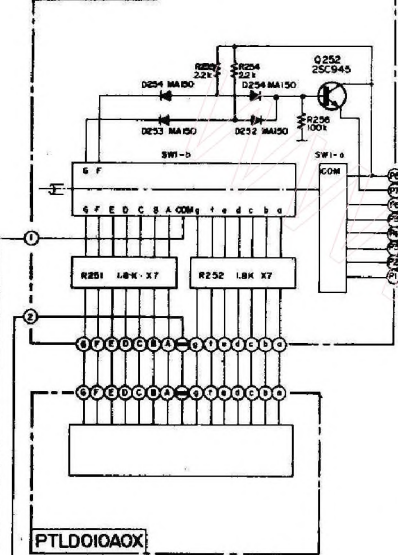

PTLD010A0X



TRANSISTOR BASE INFORMATION
E: EMITTER S: SOURCE
C: COLLECTOR B: BATE
D: BASE D: DRAIN

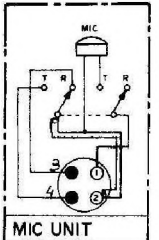
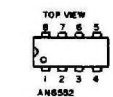
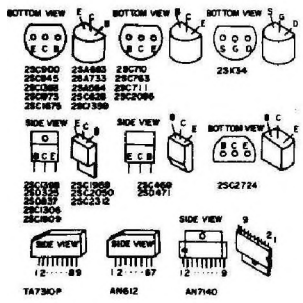

V.CO/MIX

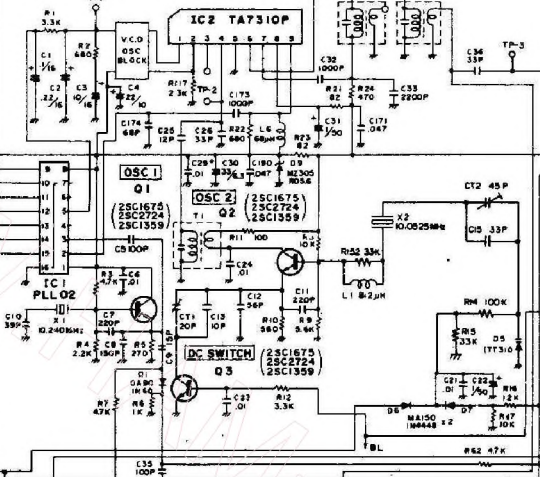

MIX/RF ALC

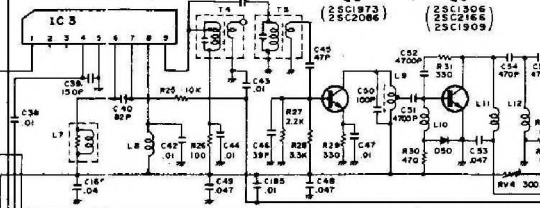

RF PRE AMP

RF DRIVER

RF POWER

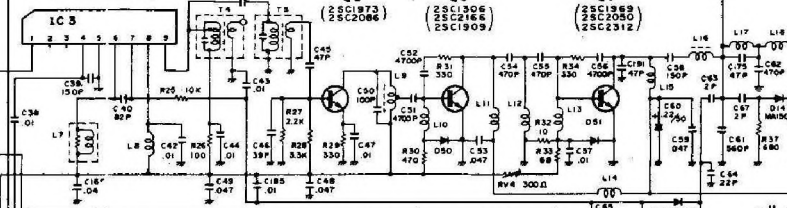

PTSRO21A0X

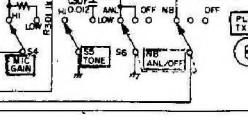
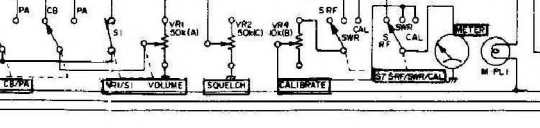
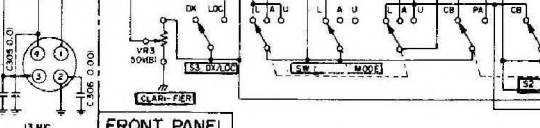
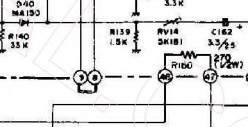
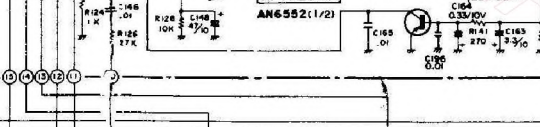
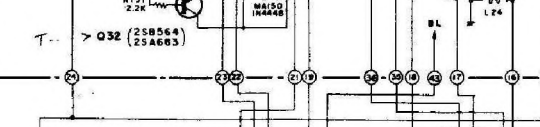
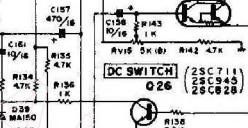
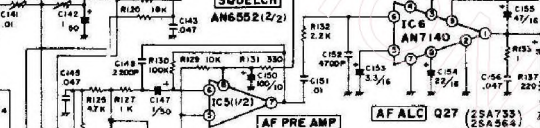
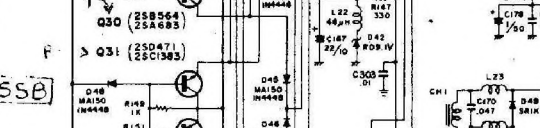
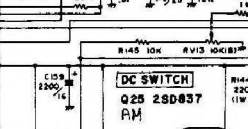
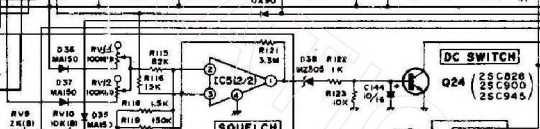
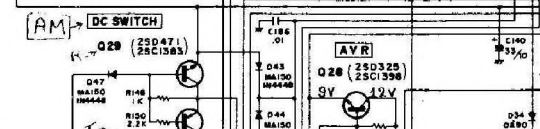
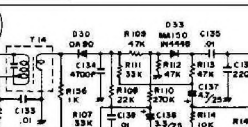
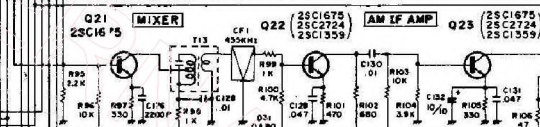
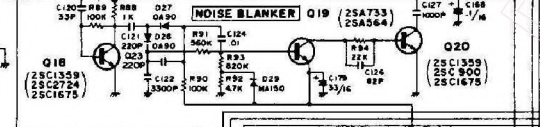
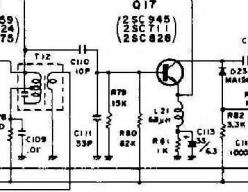
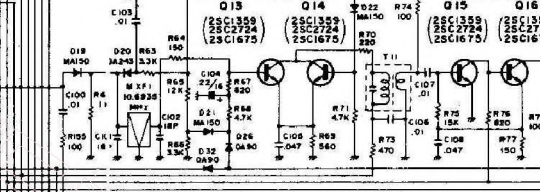
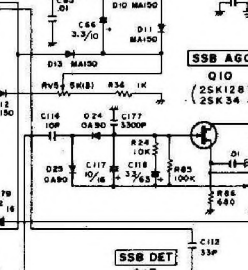
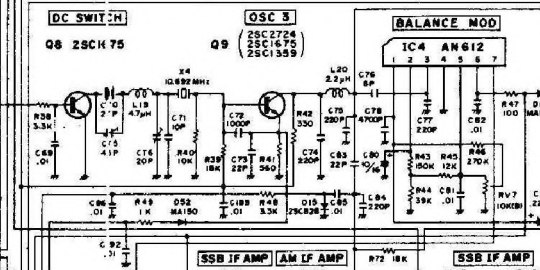
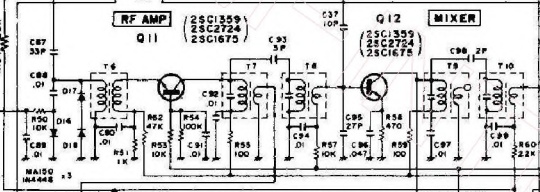
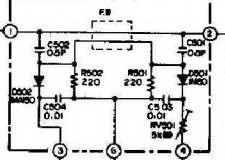

PTBM122DOX

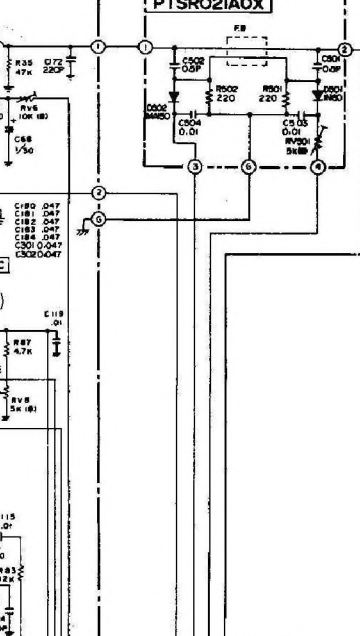

REAR PANEL

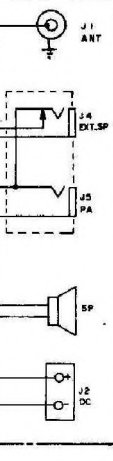

FRONT PANEL

