

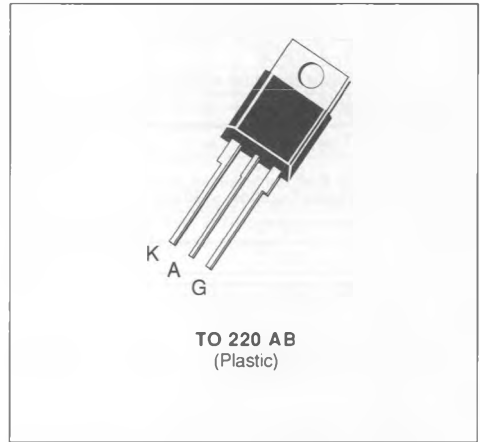

**THYRISTORS**

- GLASS PASSIVATED CHIP
- POSSIBILITY OF MOUNTING ON PRINTED CIRCUIT
- AVAILABLE IN NON-INSULATED VERSION → TYN SERIES OR IN INSULATED VERSION → TXN SERIES (INSULATING VOLTAGE 2500 V<sub>RMS</sub>)
- UL RECOGNIZED FOR TXN SERIES (E81734)



**DESCRIPTION**

SCR 's designed for motor control, heating controls, power supplies...

**ABSOLUTE RATINGS** (limiting values)

Symbol	Parameter	Value	Unit
$I_{T(RMS)}$	RMS on-state Current (1)	$T_c = 80\text{ }^\circ\text{C}$ 12	A
$I_{T(AV)}$	Mean on-state Current (1)	$T_c = 80\text{ }^\circ\text{C}$ 8	A
$I_{TSM}$	Non Repetitive Surge Peak on-state Current ( $T_j$ initial = 25 °C) (2)	$t = 8.3\text{ ms}$ 125	A
		$t = 10\text{ ms}$ 120	
$I^2t$	$I^2t$ Value for Fusing	$t = 10\text{ ms}$ 72	A <sup>2</sup> s
$di/dt$	Critical Rate of Rise of on-state Current (3)	100	A/ $\mu$ s
$T_{stg}$ $T_j$	Storage and Operating Junction Temperature Range	- 40 to 125	°C
		- 40 to 125	°C

Symbol	Parameter	TXN/TYN						Unit	
		0512	112	212	412	612	812		1012
$V_{DRM}$ $V_{RRM}$	Repetitive Peak off-state Voltage (4)	50	100	200	400	600	800	1000	V

- (1) Single phase circuit, 180° conduction angle.  
 (2) Half sine wave.  
 (3)  $I_G = 150\text{ mA}$   $di_G/dt = 1\text{ A}/\mu\text{s}$ .  
 (4)  $T_j = 125\text{ }^\circ\text{C}$ .

**THERMAL RESISTANCES**

Symbol	Parameter	Value	Unit
$R_{th(j-c)}$	Junction-case for D.C.	3.8	°C/W
$R_{th(j-a)}$	Junction-ambient	60	°C/W

**GATE CHARACTERISTICS** (maximum values)

$P_{GM} = 20 \text{ W}$  ( $t_p = 20 \mu\text{s}$ )

$I_{FGM} = 2 \text{ A}$  ( $t_p = 20 \mu\text{s}$ )

$V_{RGM} = 5 \text{ V}$

$P_{G(AV)} = 0.5 \text{ W}$

$V_{FGM} = 15 \text{ V}$  ( $t_p = 20 \mu\text{s}$ )

**ELECTRICAL CHARACTERISTICS**

Symbol	Test Conditions			Min.	Typ.	Max.	Unit
$I_{GT}$	$T_j = 25 \text{ }^\circ\text{C}$ Pulse Duration > 20 $\mu\text{s}$	$V_D = 12 \text{ V}$	$R_L = 33 \Omega$			15	mA
$V_{GT}$	$T_j = 25 \text{ }^\circ\text{C}$ Pulse Duration > 20 $\mu\text{s}$	$V_D = 12 \text{ V}$	$R_L = 33 \Omega$			1.5	V
$V_{GD}$	$T_j = 125 \text{ }^\circ\text{C}$	$V_D = V_{DRM}$	$R_L = 3.3 \text{ k}\Omega$	0.2			V
$I_H$	$T_j = 25 \text{ }^\circ\text{C}$	$I_T = 100 \text{ mA}$	Gate Open			30	mA
$I_L$	$T_j = 25 \text{ }^\circ\text{C}$ Pulse Duration > 20 $\mu\text{s}$	$V_D = 12 \text{ V}$	$I_G = 30 \text{ mA}$		50		mA
$V_{TM}$	$T_j = 25 \text{ }^\circ\text{C}$	$I_{TM} = 24 \text{ A}$	$t_p = 10 \text{ ms}$			1.6	V
$I_{DRM}$	$T_j = 25 \text{ }^\circ\text{C}$	$V_{DRM}$ Specified				0.01	mA
	$T_j = 125 \text{ }^\circ\text{C}$	$V_{DRM} \leq 800 \text{ V}$				2	
		$V_{DRM} = 1000 \text{ V}$				3	
$I_{RRM}$	$T_j = 25 \text{ }^\circ\text{C}$	$V_{RRM}$ Specified				0.01	mA
	$T_j = 125 \text{ }^\circ\text{C}$	$V_{RRM} \leq 800 \text{ V}$				2	
		$V_{RRM} = 1000 \text{ V}$				3	
$t_{gt}$	$T_j = 25 \text{ }^\circ\text{C}$ $I_G = 40 \text{ mA}$	$V_D = V_{DRM}$ $di_G/dt = 0.45 \text{ A}/\mu\text{s}$	$I_T = 24 \text{ A}$		2		$\mu\text{s}$
$t_q$	$T_j = 125 \text{ }^\circ\text{C}$ $V_D = 67 \% V_{DRM}$ Gate Open	$I_T = 24 \text{ A}$ $di/dt = 30 \text{ A}/\mu\text{s}$	$V_R = 25 \text{ V}$ $dv/dt = 50 \text{ V}/\mu\text{s}$		70		$\mu\text{s}$
$dv/dt^*$	$T_j = 125 \text{ }^\circ\text{C}$ Linear Slope up to $V_D = 67 \% V_{DRM}$	Gate Open		200			V/ $\mu\text{s}$

\* For higher guaranteed values, please consult us.

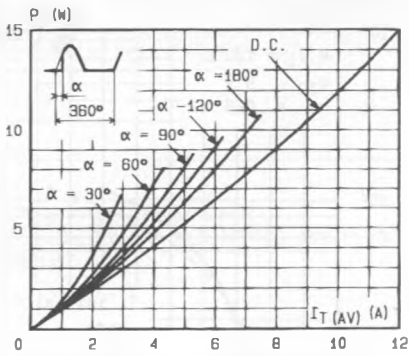

Fig. 1 - Maximum mean power dissipation versus mean on-state current.

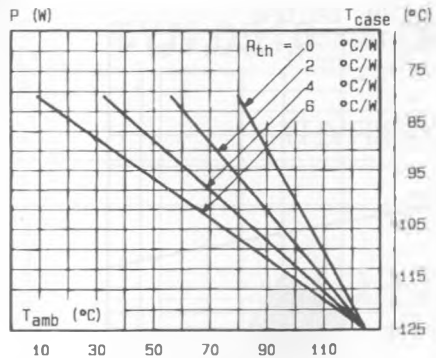

Fig. 2 - Correlation between maximum mean power dissipation and maximum allowable temperatures ( $T_{amb}$  and  $T_{case}$ ) for different thermal resistances heatsink + contact.

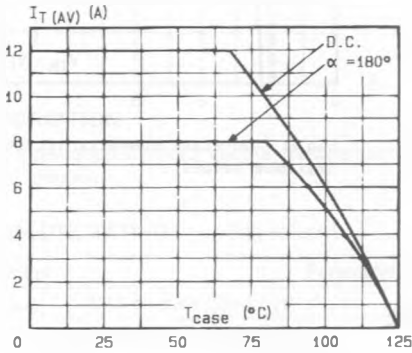

Fig. 3 - Mean on-state current versus case temperature.

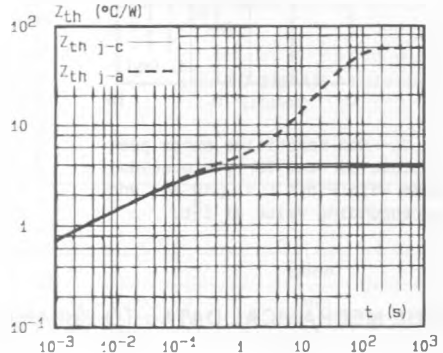

Fig. 4 - Thermal transient impedance junction to case and junction to ambient versus pulse duration.

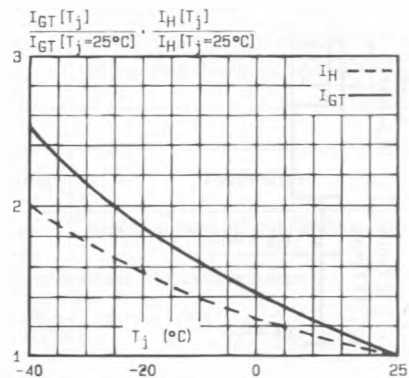

Fig. 5 - Relative variation of gate trigger current and holding current versus junction temperature.

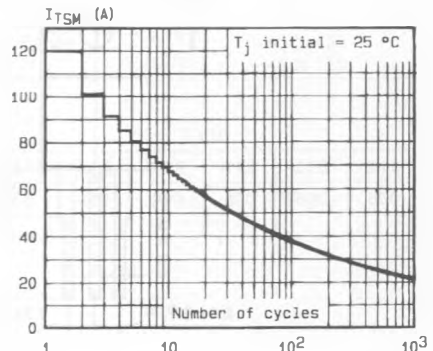

Fig. 6 - Non repetitive surge peak on-state current versus number of cycles.

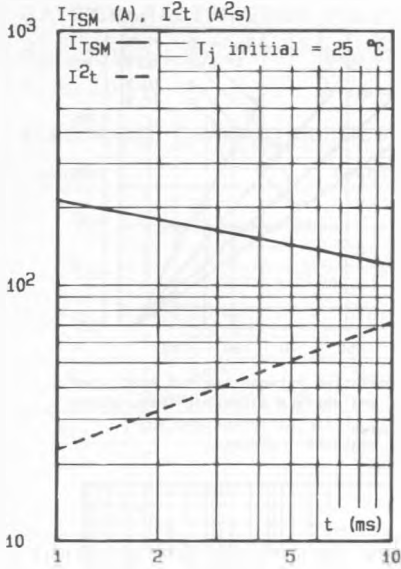

Fig.7 - Non repetitive surge peak on-state current for a sinusoidal pulse with width :  $t \leq 10$  ms, and corresponding value of  $I^2t$ .

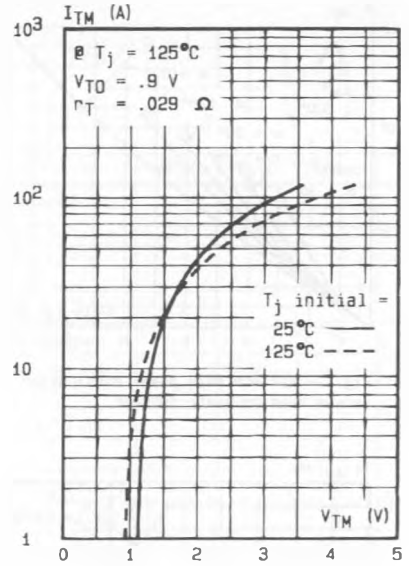
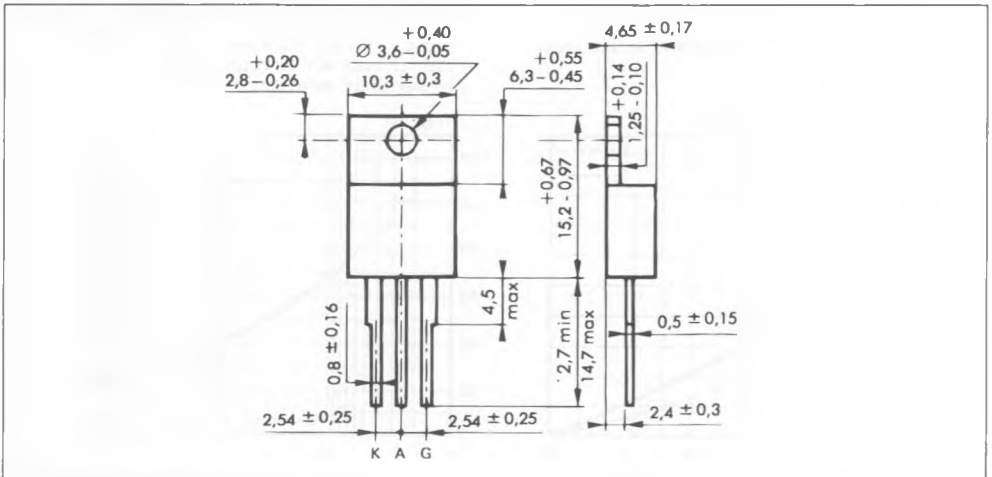

Fig.8 - On-state characteristics (maximum values).

PACKAGE MECHANICAL DATA : TO 220 AB Plastic



Cooling method : by conduction (method C)  
 Marking : type number  
 Weight : 2 g