

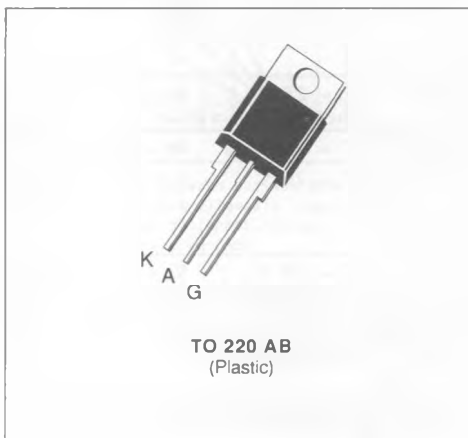

THYRISTORS

- GLASS PASSIVATED CHIP
- POSSIBILITY OF MOUNTING ON PRINTED CIRCUIT
- AVAILABLE IN NON-INSULATED VERSION → TYN SERIES OR IN INSULATED VERSION → TXN SERIES (INSULATING VOLTAGE 2500 V<sub>RMS</sub>)
- UL RECOGNIZED FOR TXN SERIES (E81734)



**DESCRIPTION**

SCR's designed for motor control, heating controls, power supplies...

**ABSOLUTE RATINGS** (limiting values)

Symbol	Parameter		Value	Unit
I <sub>T(RMS)</sub>	RMS on-state Current (1)	T <sub>c</sub> = 75 °C	8	A
I <sub>T(AV)</sub>	Mean on-state Current (1)	T <sub>c</sub> = 75 °C	5	A
I <sub>TSM</sub>	Non Repetitive Surge Peak on-state Current (T <sub>j</sub> initial = 25 °C) (2)	t = 8.3 ms	84	A
		t = 10 ms	80	
I <sup>2</sup> t	I <sup>2</sup> t Value for Fusing	t = 10 ms	32	A <sup>2</sup> s
di/dt	Critical Rate of Rise of on-state Current (3)		50	A/μs
T <sub>stg</sub> T <sub>j</sub>	Storage and Operating Junction Temperature Range		- 40 to 110	°C
			- 40 to 110	°C

Symbol	Parameter	TXN/TYN ..., G, K							Unit
		058	108	208	408	608	808	1008	
V <sub>DRM</sub> V <sub>RRM</sub>	Repetitive Peak off-state Voltage (4)	50	100	200	400	600	800	1000	V

(1) Single phase circuit, 180° conduction angle.

(2) Half sine wave

(3) I<sub>G</sub> = 400 mA di/dt = 1 A/μs

(4) T<sub>j</sub> = 110 °C.

**THERMAL RESISTANCES**

Symbol	Parameter	Value	Unit
R <sub>th(j-c)</sub>	Junction-case for D.C.	4.7	°C/W
R <sub>th(j-a)</sub>	Junction-ambient	60	°C/W

**GATE CHARACTERISTICS** (maximum values)

$P_{GM} = 20 \text{ W}$  ( $t_p = 20 \mu\text{s}$ )

$I_{FGM} = 2 \text{ A}$  ( $t_p = 20 \mu\text{s}$ )

$V_{RGM} = 5 \text{ V}$

$P_{G(AV)} = 0.5 \text{ W}$

$V_{FGM} = 15 \text{ V}$  ( $t_p = 20 \mu\text{s}$ )

**ELECTRICAL CHARACTERISTICS**

Symbol	Test Conditions			Min.	Typ.	Max.	Unit
$I_{GT}$	$T_j = 25 \text{ }^\circ\text{C}$ Pulse Duration > 20 $\mu\text{s}$	$V_D = 12 \text{ V}$	$R_L = 33 \text{ } \Omega$	Without Suffix		15	mA
				Suffix G		25	
				Suffix K		40	
$V_{GT}$	$T_j = 25 \text{ }^\circ\text{C}$ Pulse Duration > 20 $\mu\text{s}$	$V_D = 12 \text{ V}$	$R_L = 33 \text{ } \Omega$			1.5	V
$V_{GD}$	$T_i = 110 \text{ }^\circ\text{C}$	$V_D = V_{DRM}$	$R_L = 3.3 \text{ k}\Omega$	0.2			V
$I_H$	$T_j = 25 \text{ }^\circ\text{C}$	$I_T = 100 \text{ mA}$	Gate Open	Without Suffix		30	mA
				Suffix G		45	
				Suffix K		60	
$I_L$	$T_j = 25 \text{ }^\circ\text{C}$ Pulse Duration > 20 $\mu\text{s}$	$V_D = 12 \text{ V}$	$I_G = 80 \text{ mA}$		50		mA
$V_{TM}$	$T_j = 25 \text{ }^\circ\text{C}$	$I_{TM} = 16 \text{ A}$	$t_p = 10 \text{ ms}$			1.6	V
$I_{DRM}$	$V_{DRM}$ Specified			$T_j = 25 \text{ }^\circ\text{C}$		0.01	mA
				$T_j = 110 \text{ }^\circ\text{C}$		1	
$I_{RRM}$	$V_{RRM}$ Specified			$T_j = 25 \text{ }^\circ\text{C}$		0.01	mA
				$T_j = 110 \text{ }^\circ\text{C}$		1	
$t_{gt}$	$T_j = 25 \text{ }^\circ\text{C}$ $I_G = 40 \text{ mA}$	$V_D = V_{DRM}$ $di_G/dt = 0.45 \text{ A}/\mu\text{s}$		$I_T = 16 \text{ A}$	2		$\mu\text{s}$
$t_q$	$T_j = 110 \text{ }^\circ\text{C}$ $V_D = 67 \% V_{DRM}$ $dv/dt = 50 \text{ V}/\mu\text{s}$	$I_T = 16 \text{ A}$ $di/dt = 30 \text{ A}/\mu\text{s}$		$V_R = 25 \text{ V}$ Gate Open	70		$\mu\text{s}$
$dv/dt^*$	$T_j = 110 \text{ }^\circ\text{C}$ Gate Open Linear Slope up to $V_D = 67 \% V_{DRM}$			Without Suffix	200		V/ $\mu\text{s}$
				Suffix G	500		
				Suffix K	750		

\* For higher guaranteed values, please consult us.

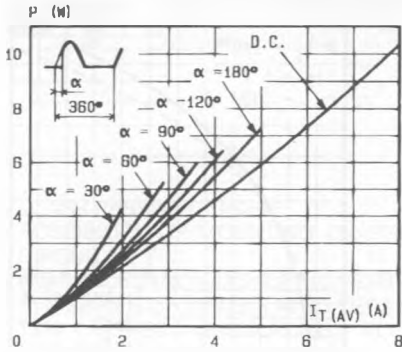

Fig. 1 - Maximum mean power dissipation versus mean on-state current.

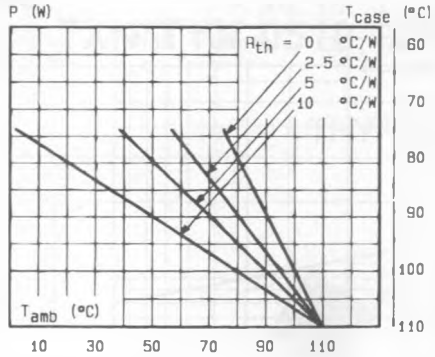

Fig. 2 - Correlation between maximum mean power dissipation and maximum allowable temperatures ( $T_{amb}$  and  $T_{case}$ ) for different thermal resistances heatsink + contact.

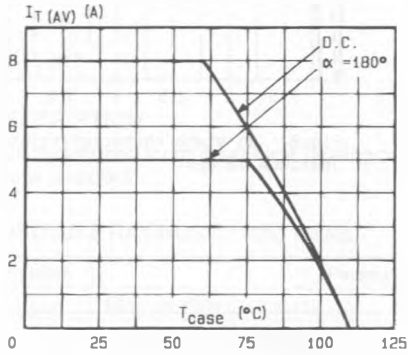

Fig. 3 - Mean on-state current versus case temperature.

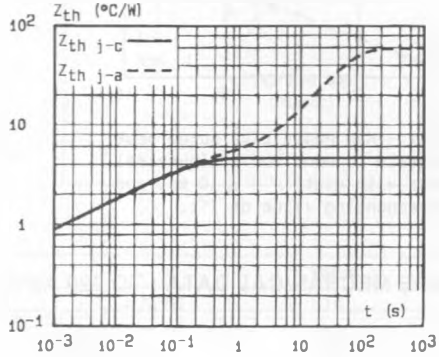

Fig. 4 - Thermal transient impedance junction to case and junction to ambient versus pulse duration.

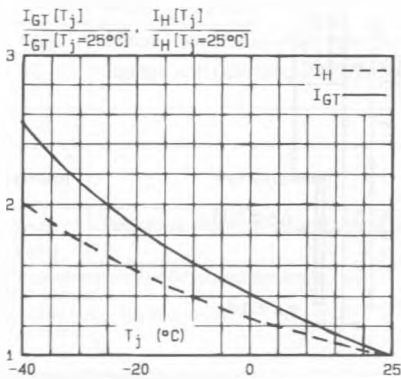

Fig. 5 - Relative variation of gate trigger current and holding current versus junction temperature.

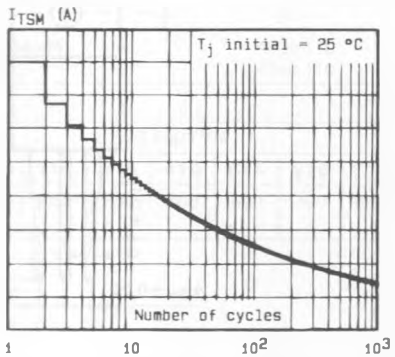

Fig. 6 - Non repetitive surge peak on-state current versus number of cycles.

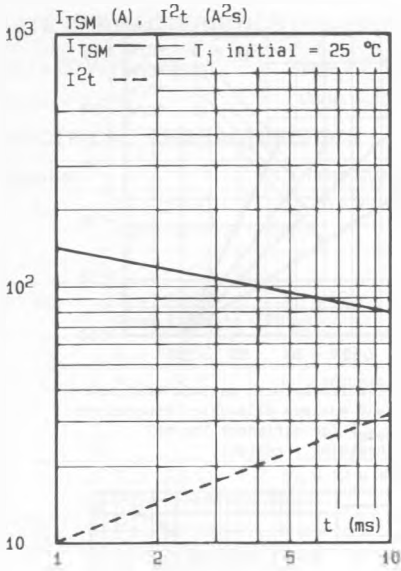

Fig.7 - Non repetitive surge peak on-state current for a sinusoidal pulse with width :  $t \leq 10$  ms, and corresponding value of  $I^2t$ .

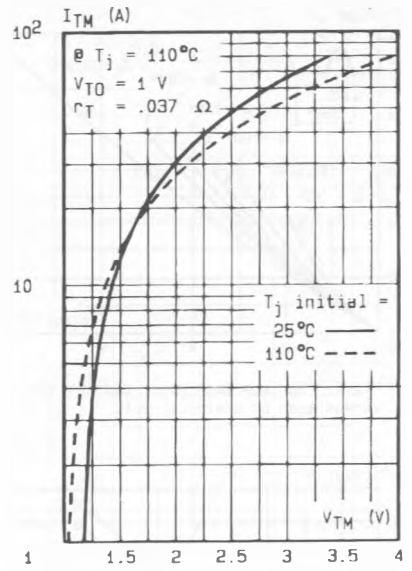
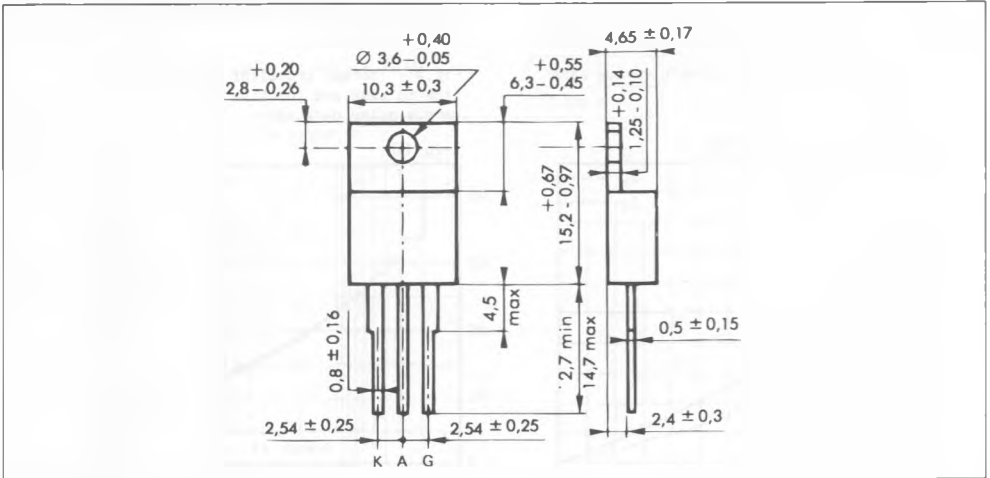

Fig.8 - On-state characteristics (maximum values).

PACKAGE MECHANICAL DATA : TO 220 AB Plastic



Cooling method : by conduction (method C)  
 Marking : type number  
 Weight : 2 g