

Thyristors

SKT 40
SKT 50



V _{RSM}	V _{RRM} V _{DRM}	$\left(\frac{dv}{dt}\right)_{cr}$	I _T RMS (maximum values for continuous operation)	
			63 A	78 A
V	V	V/μs	I _{TAV} (sin. 180; T _{case} = . . . °C)	
			40 A (80 °C)	50 A (78 °C)
500	400	500	SKT 40/04 D	–
700	600	500	SKT 40/06 D	SKT 50/06 D*
900	800	500	SKT 40/08 D	SKT 50/08 D
1300	1200	1000	SKT 40/12 E	SKT 50/12 E*
1500	1400	1000	SKT 40/14 E	SKT 50/14 E*
1700	1600	1000	SKT 40/16 E	SKT 50/16 E*
1900	1800	1000	SKT 40/18 E+	SKT 50/18 E+

Symbol	Conditions	SKT 40	SKT 50	Units
I _{TAV}	sin. 180; T _{case} = 85 °C	38	45	A
I _{TSM}	T _{vj} = 25 °C; 10 ms T _{vj} = 130 °C; 10 ms	700 600	1050 900	A A
i ² t	T _{vj} = 25 °C; 8,35 ... 10 ms T _{vj} = 130 °C; 8,35 ... 10 ms	2500 1800	5000 4000	A ² s A ² s
t _{gd}	T _{vj} = 25 °C; I _G = 1 A; di _G /dt = 1 A/μs	typ. 1		μs
t _{gr}	V _D = 0,67 · V _{DRM}	typ. 1,5		μs
(di/dt) _{cr}	f = 50 ... 60 Hz	50		A/μs
I _H	T _{vj} = 25 °C	typ. 100; max. 200		mA
I _L	T _{vj} = 25 °C; R _G = 33 Ω	typ. 250; max. 400		mA
t _q	T _{vj} = 130 °C; typ.	100		μs
V _T	T _{vj} = 25 °C; I _T = 120 A; max.	1,95	1,8	V
V _{T(TO)}	T _{vj} = 130 °C	1,0	1,1	V
r _T	T _{vj} = 130 °C	9	5	mΩ
I _{DD} , I _{RD}	T _{vj} = 130 °C; V _{DD} = V _{DRM} V _{RD} = V _{RRM}	8	8	mA
V _{GT}	T _{vj} = 25 °C	3		V
I _{GT}	T _{vj} = 25 °C	150		mA
V _{GD}	T _{vj} = 130 °C	0,25		V
I _{GD}	T _{vj} = 130 °C	5		mA
R _{thjc}	cont. sin. 180 rec. 120	0,60 0,66 0,70	0,57 0,60 0,65	°C/W °C/W °C/W
R _{thch}		0,20		°C/W
T _{vj}		– 40 ... +130		°C
T _{stg}		– 55 ... +150		°C
M	SI units US units	4 (UNF: 2,5) 35 (UNF: 22)		Nm lb. in.
a		5 · 9,81		m/s ²
w		2,2		g
Case		B 3		

Features

- Hermetic metal cases with glass insulators
- Threaded studs ISO M8 or UNF 1/4-28
- International standard cases

Typical Applications

- DC motor control (e. g. for machine tools)
- Controlled rectifiers (e. g. for battery charging)
- AC controllers (e. g. for temperature control)

* Available with UNF thread 1/4-28 UNF2A, e.g. SKT 50/06 D UNF

♦ available in limited quantities

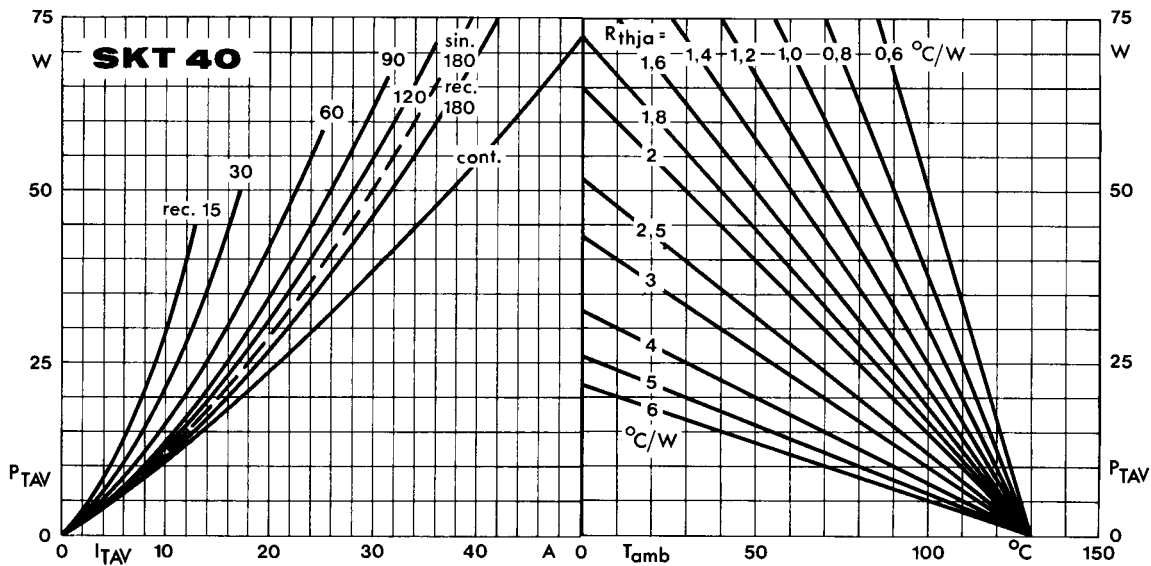

Fig. 1 a Power dissipation vs. on-state current and ambient temperature

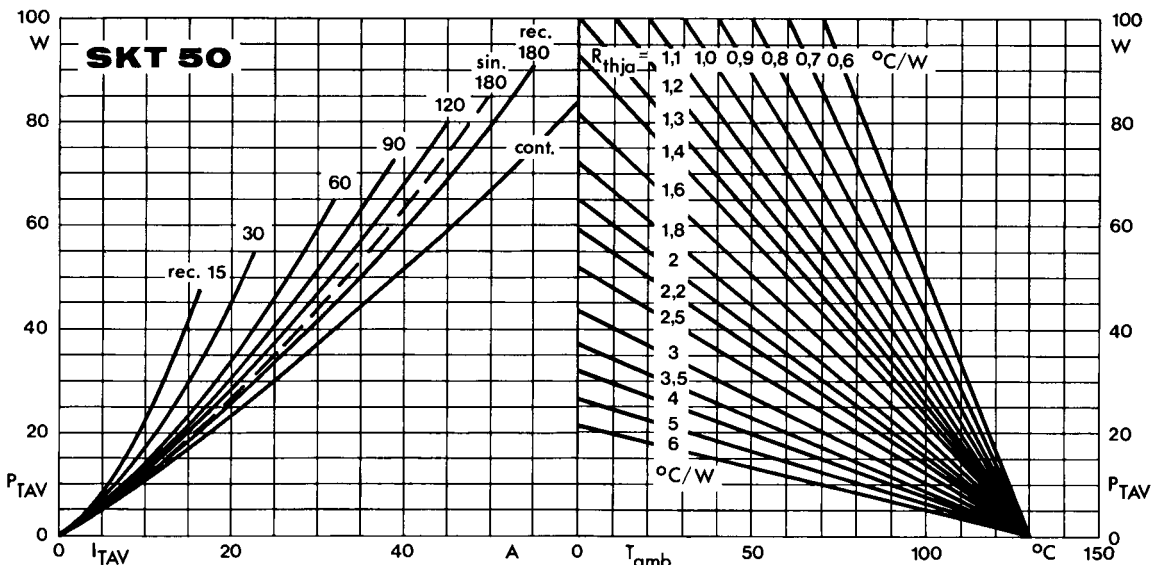

Fig. 1 b Power dissipation vs. on-state current and ambient temperature

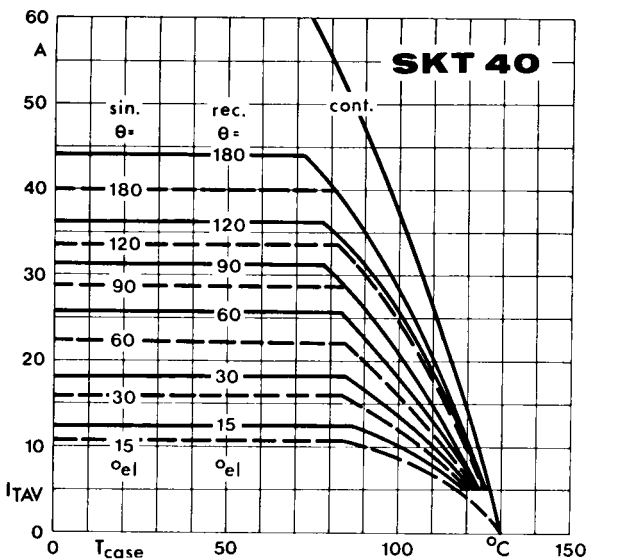

Fig. 2 a Rated on-state current vs. case temperature

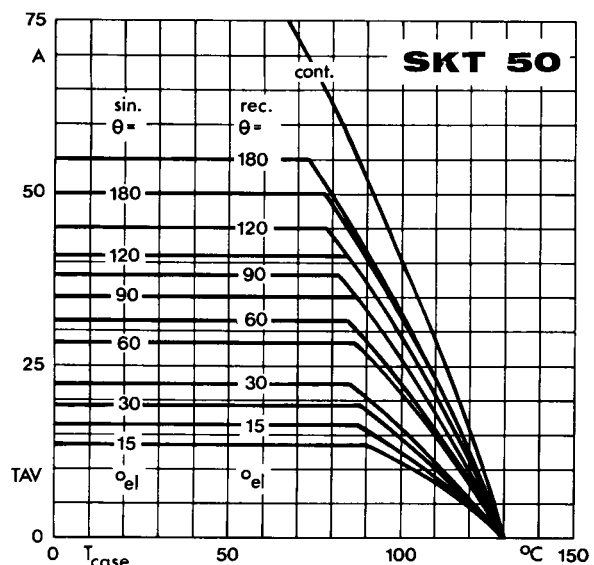

Fig. 2 b Rated on-state current vs. case temperature

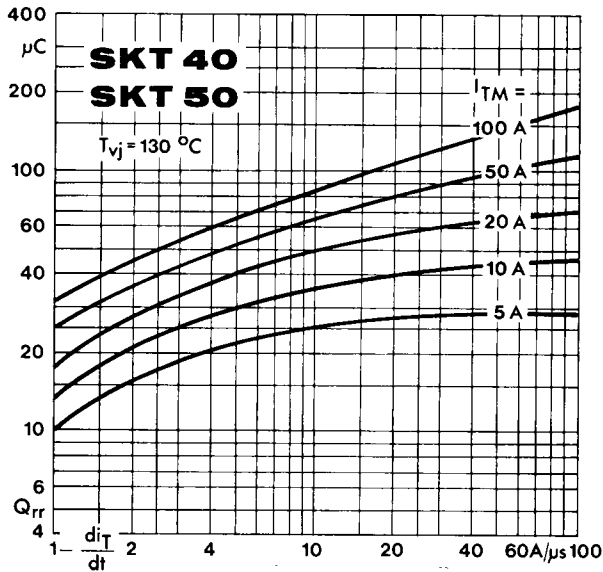

Fig. 3 Recovered charge vs. current decrease

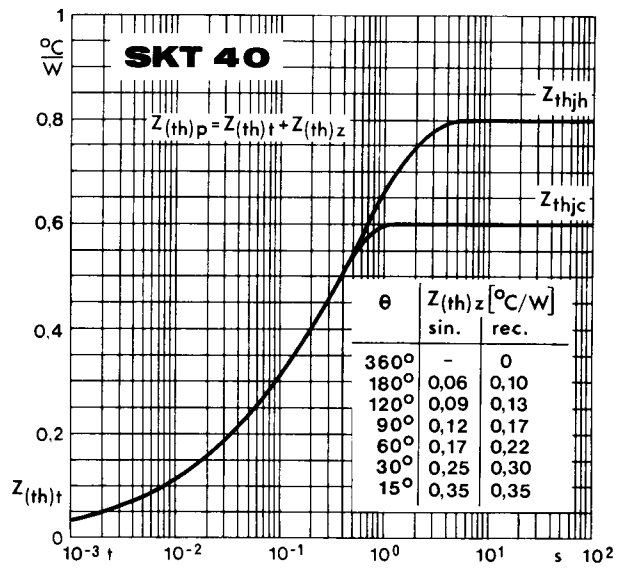

Fig. 4 a Transient thermal impedance vs. time

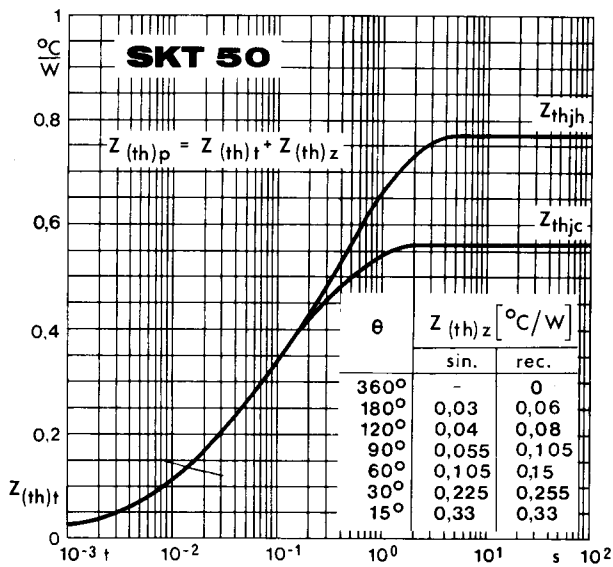

Fig. 4 b Transient thermal impedance vs. time

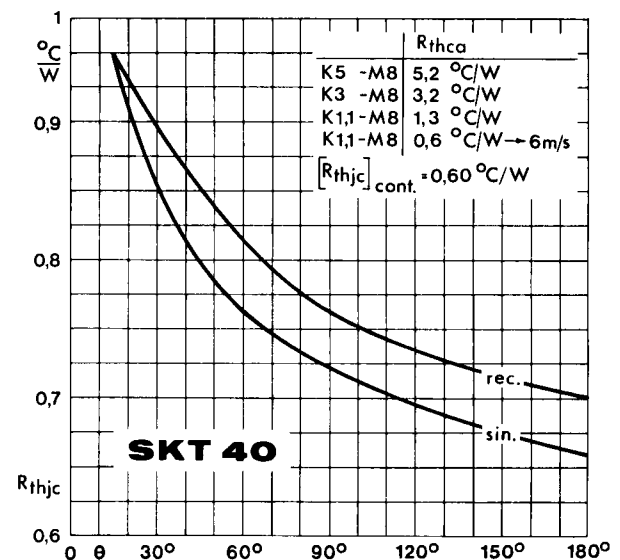

Fig. 5 a Thermal resistance vs. conduction angle

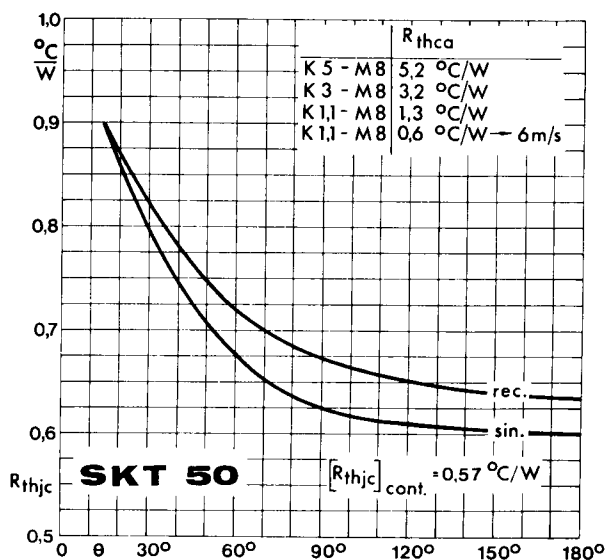

Fig. 5 b Thermal resistance vs. conduction angle

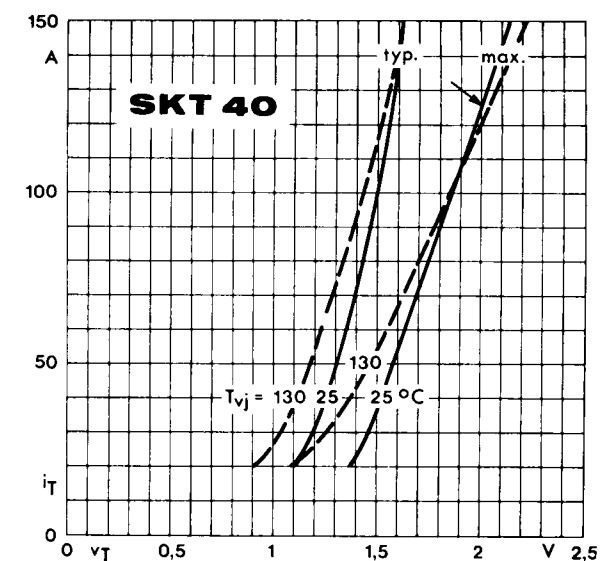

Fig. 6 a On-state characteristics

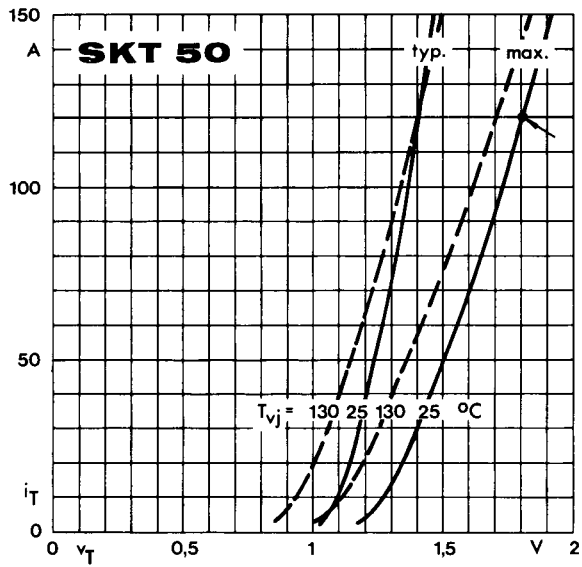

Fig. 6 b On-state characteristics

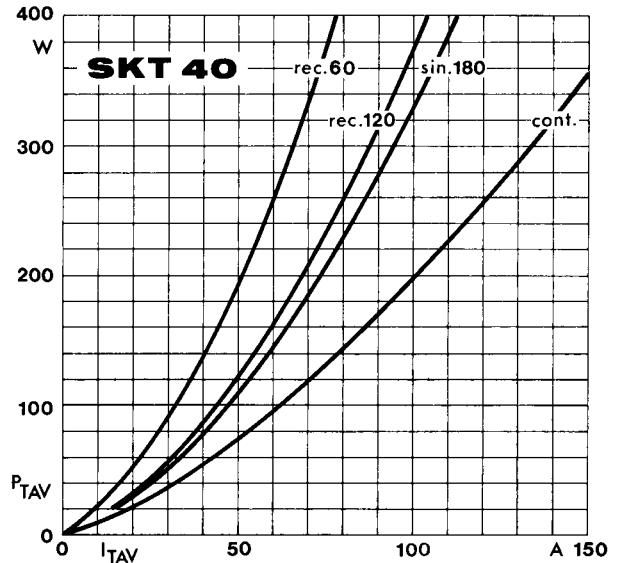

Fig. 7 a Power dissipation vs. on-state current

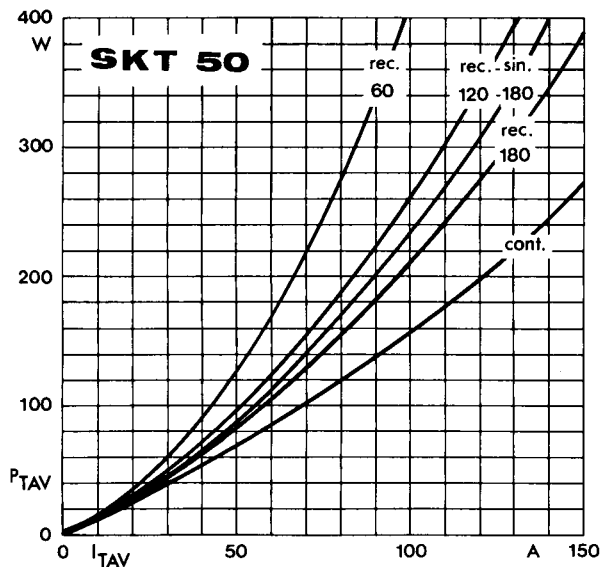

Fig. 7 b Power dissipation vs. on-state current

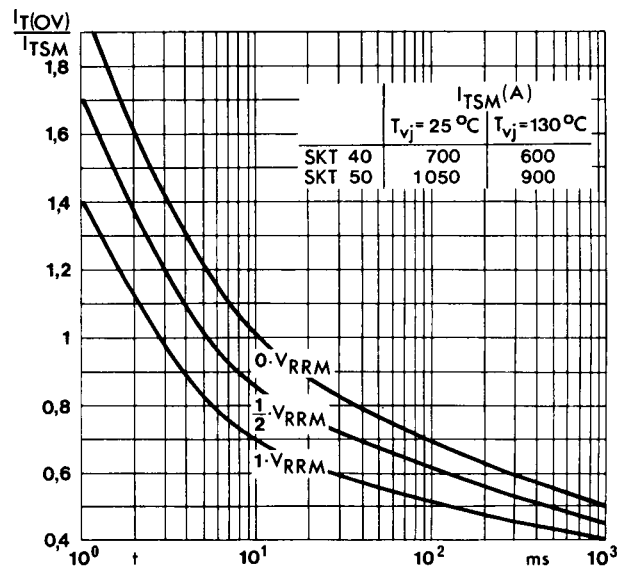

Fig. 8 Surge overload current vs. time

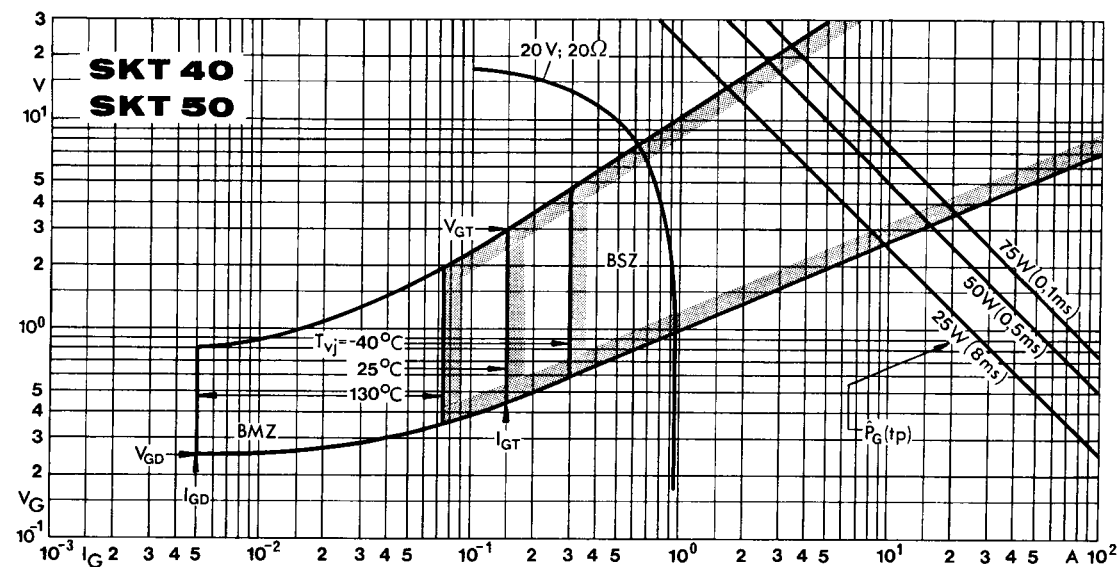

Fig. 9 Gate trigger characteristics

SKT 10

Case B 1

IEC-Publ. 191-2: A 13 M

DIN 41891: 200 B 3

BS 3934: SO-35 A

JEDEC: TO-208 AB (TO-64) metric

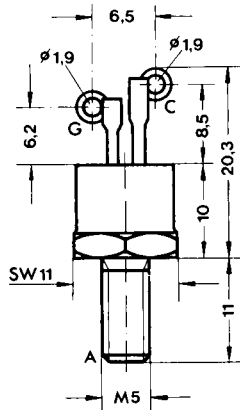
**SKT 16**
SKT 24

Case B 2

IEC-Publ. 191-2: A 11 M, A 11 U

DIN 41892: 201 C 3

BS 3934: SO-36

JEDEC: TO-208 AA (TO-48)

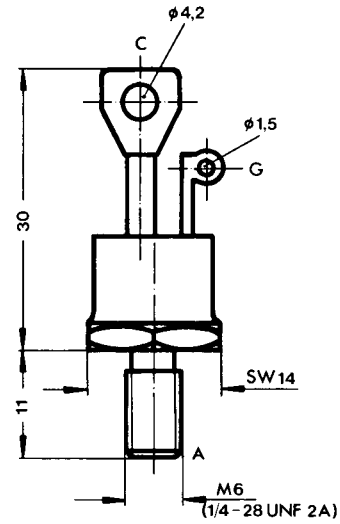
**SKT 40**
SKT 50

Case B 3

IEC-Publ. 191-2: A 38 MA, A 14 U

DIN 41892: 202 C 3

BS 3934: SO-28

JEDEC: TO-208 AC (TO-65)

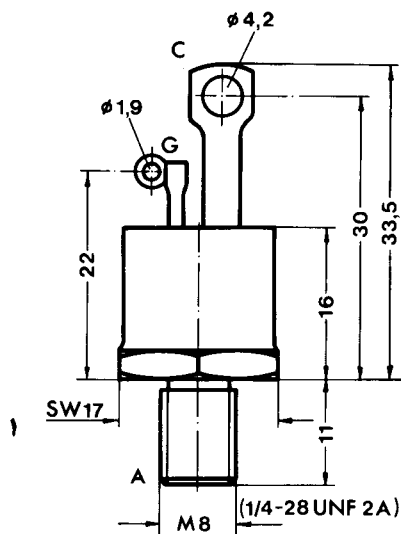

C: Cathode terminal
 A: Anode terminal
 G: Gate terminal

Dimensions in mm