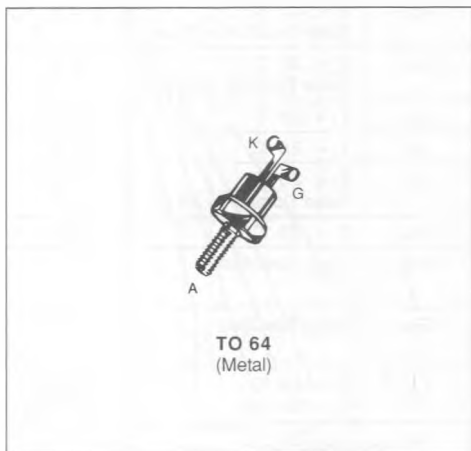

THYRISTORS

- GLASS PASSIVATED CHIP
- HIGH STABILITY AND RELIABILITY

DESCRIPTION

General purpose SCR suited for power supplies up to 400 Hz on resistive or inductive loads.

ABSOLUTE RATINGS (limiting values)

Symbol	Parameter		Value	Unit
$I_{T(RMS)}$	RMS on-state Current (1)	$T_c = 90\text{ }^\circ\text{C}$	7.4	A
$I_{T(AV)}$	Mean on-state Current (1)	$T_c = 90\text{ }^\circ\text{C}$	4.7	A
I_{TSM}	Non Repetitive Surge Peak on-state Current (T_j initial $\leq 125\text{ }^\circ\text{C}$) (2)	$t = 8.3\text{ ms}$	84	A
		$t = 10\text{ ms}$	80	
I^2t	I^2t Value for Fusing	$t = 10\text{ ms}$	32	A^2s
di/dt	Critical Rate of Rise of on-state Current (3)		100	$\text{A}/\mu\text{s}$
T_{stg} T_j	Storage and Operating Junction Temperature Range		- 65 to 150	$^\circ\text{C}$
			- 65 to 125	$^\circ\text{C}$

Symbol	Parameter	2N1770	2N1771	2N1772	2N1773	2N1774	2N1775	2N1776	2N1777	2N1778	2N2619	Unit
V_{DRM} V_{RRM}	Repetitive Peak off-state Voltage (4)	25	50	100	150	200	250	300	400	500	600	V

1 Single phase circuit, 180° conduction angle

2 Half sine wave

3 $I_G = 150\text{ mA}$ $di_G/dt = 1\text{ A}/\mu\text{s}$.

4 $T = 125\text{ }^\circ\text{C}$.

THERMAL RESISTANCES

Symbol	Parameter	Value	Unit
$R_{th(j-c)}$	Junction-case for D.C.	4.4	$^\circ\text{C}/\text{W}$
$R_{th(c-h)}$	Contact (case to heatsink)	0.4	$^\circ\text{C}/\text{W}$

GATE CHARACTERISTICS (maximum values)

$P_{GM} = 5 \text{ W}$ ($t_p = 100 \mu\text{s}$) $I_{FGM} = 2 \text{ A}$ ($t_p = 100 \mu\text{s}$) $V_{RGM} = 5 \text{ V}$
 $P_{G(AV)} = 0.5 \text{ W}$ $V_{FGM} = 10 \text{ V}$ ($t_p = 100 \mu\text{s}$)

ELECTRICAL CHARACTERISTICS

Symbol	Test Conditions			Min.	Typ.	Max.	Unit
I_{GT}	$T_j = 25 \text{ }^\circ\text{C}$ Pulse Duration > 20 μs	$V_D = 12 \text{ V}$	$R_L = 33 \text{ } \Omega$		10	15	mA
V_{GT}	$T_j = 25 \text{ }^\circ\text{C}$ Pulse Duration > 20 μs	$V_D = 12 \text{ V}$	$R_L = 33 \text{ } \Omega$			1.5	V
V_{GD}	$T_j = 125 \text{ }^\circ\text{C}$	$V_D = V_{DRM}$	$R_L = 3.3 \text{ k}\Omega$.2			V
I_H	$T_j = 25 \text{ }^\circ\text{C}$	$I_T = 0.5 \text{ A}$	Gate Open		20	30	mA
I_L	$T_j = 25 \text{ }^\circ\text{C}$ Pulse Duration > 20 μs	$V_D = 12 \text{ V}$	$I_G = 30 \text{ mA}$		40		mA
V_{TM}	$T_j = 25 \text{ }^\circ\text{C}$	$I_{TM} = 15 \text{ A}$	$t_p = 10 \text{ ms}$			1.85	V
I_{DRM}	V_{DRM} Specified			$T_j = 25 \text{ }^\circ\text{C}$		0.02	mA
				$T_j = 125 \text{ }^\circ\text{C}$	1	2	
I_{RRM}	V_{RRM} Specified			$T_j = 25 \text{ }^\circ\text{C}$		0.02	mA
				$T_j = 125 \text{ }^\circ\text{C}$	1	2	
t_{gt}	$T_j = 25 \text{ }^\circ\text{C}$ $I_G = 200 \text{ mA}$	$V_D = V_{DRM}$ $di_G/dt = 2 \text{ A}/\mu\text{s}$	$I_T = 15 \text{ A}$		2		μs
t_q	$T_j = 125 \text{ }^\circ\text{C}$ $V_D = 67 \text{ } \% V_{DRM}$ Gate Open	$I_T = 15 \text{ A}$ $di/dt = 30 \text{ A}/\mu\text{s}$	$V_R = 24 \text{ V}$ $dv/dt = 20 \text{ V}/\mu\text{s}$		30		μs
dv/dt^*	$T_j = 125 \text{ }^\circ\text{C}$ Linear Slope up to $V_D = 67 \text{ } \% V_{DRM}$	Gate Open		200			V/ μs

* For higher guaranteed values, please consult us.

PACKAGE MECHANICAL DATA

TO 64 Metal

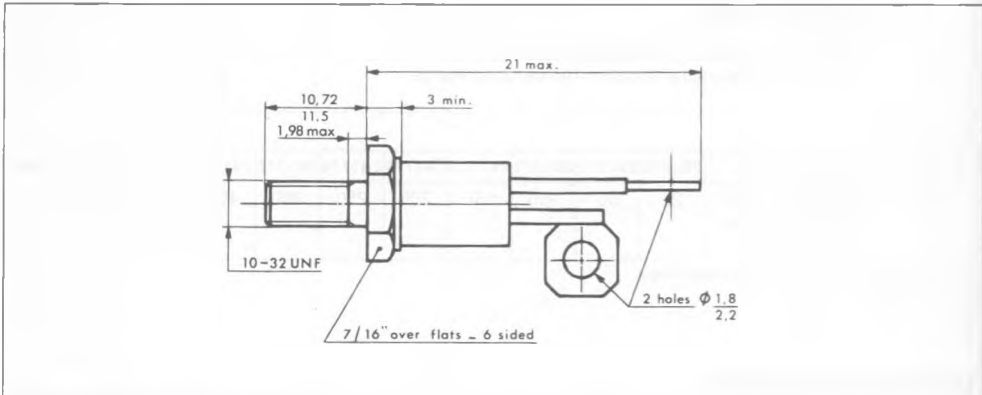

Cooling method : by conduction (method C)
 Marking : type number
 Weight : 5 g
 Polarity : anode to case
 Stud torque : 3.5 mAN min - 3.8 mAN max

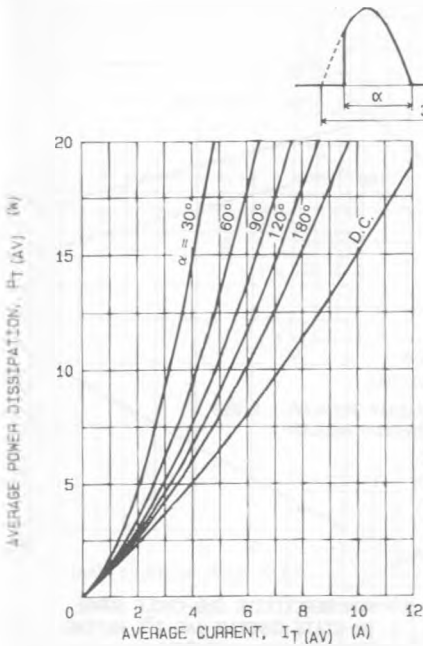

FIG. 1 - MAXIMUM ON-STATE POWER DISSIPATION FOR SIMUSOIDAL CURRENT WAVEFORM

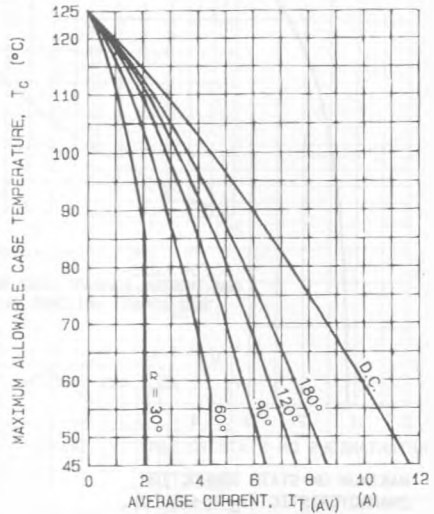

FIG. 2 - MAXIMUM ALLOWABLE CASE TEMPERATURE FOR SIMUSOIDAL CURRENT WAVEFORM

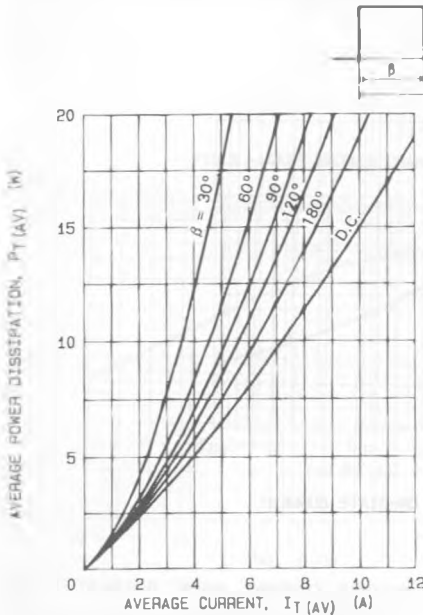

FIG. 3 - MAXIMUM ON-STATE POWER DISSIPATION FOR RECTANGULAR CURRENT WAVEFORM

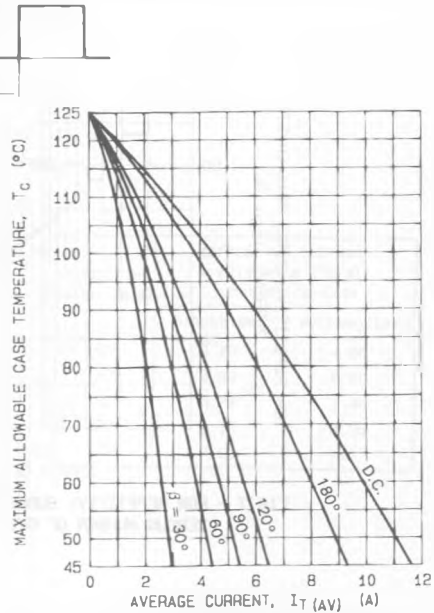

FIG. 4 - MAXIMUM ALLOWABLE CASE TEMPERATURE FOR RECTANGULAR CURRENT WAVEFORM

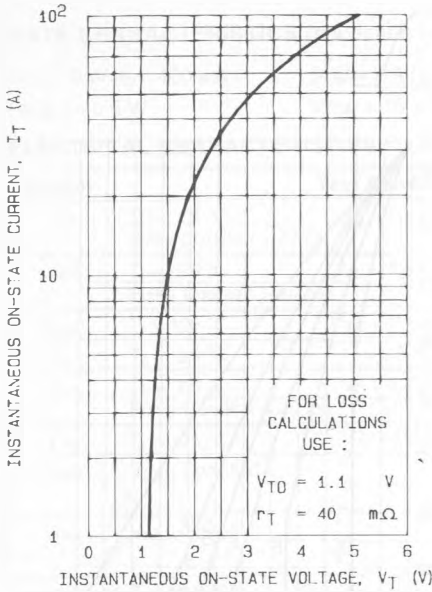

FIG.5 - MAXIMUM ON-STATE CONDUCTION CHARACTERISTIC ($T_J = 125^\circ\text{C}$).

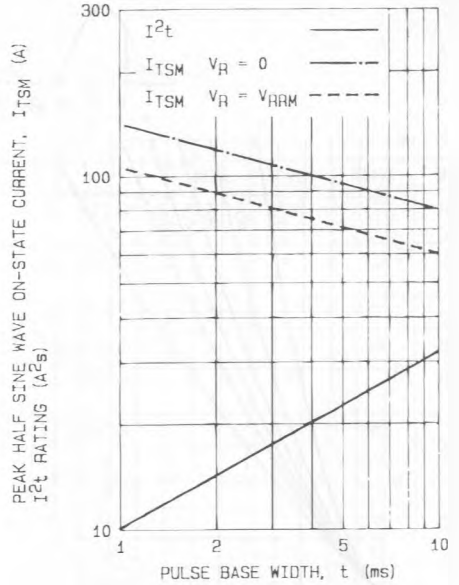

FIG.8 - NON REPETITIVE SUB-CYCLE SURGE ON-STATE CURRENT AND I^2t RATING (INITIAL $T_J = 125^\circ\text{C}$).

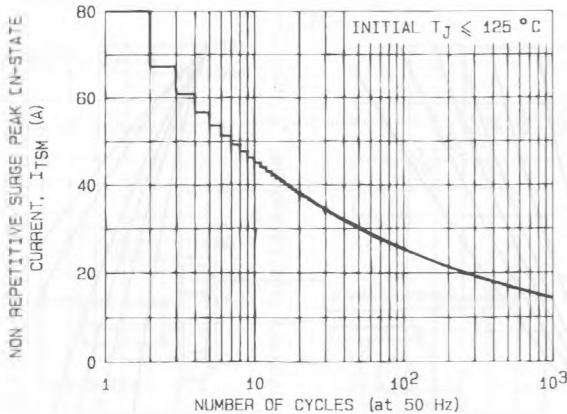

FIG.7 - NON REPETITIVE SURGE PEAK ON-STATE CURRENT VERSUS NUMBER OF CYCLES.

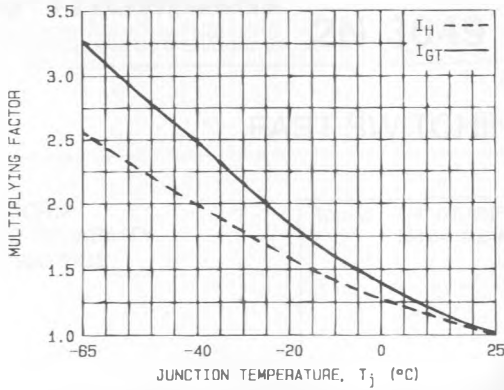

FIG. 8 - RELATIVE VARIATION OF GATE TRIGGER CURRENT AND HOLDING CURRENT VERSUS JUNCTION TEMPERATURE.

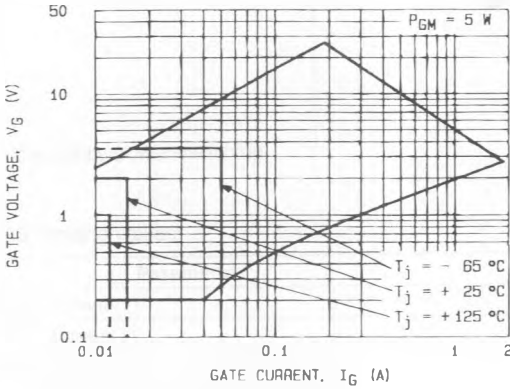

FIG. 8 - GATE TRIGGER CHARACTERISTICS.

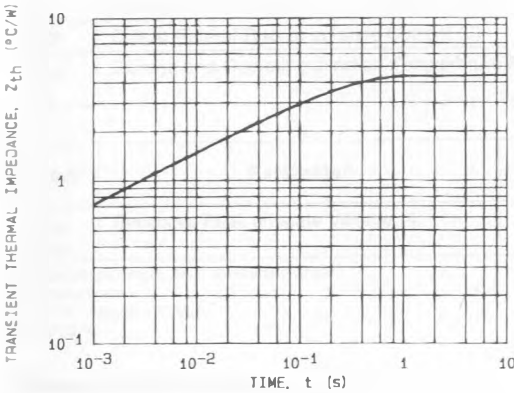

FIG. 10 - TRANSIENT THERMAL IMPEDANCE JUNCTION TO CASE.

Conduction angle (α , β)	Effective thermal resistance ($^{\circ}\text{C}/\text{W}$) junction to case	
	Sinusoidal	Rectangular
180°	4.75	4.66
120°	4.93	6.60
90°	5.28	7.48
60°	6.16	8.36
30°	7.92	.10