

HIGH VOLTAGE FAST-SWITCHING NPN POWER TRANSISTOR

- SGS-THOMSON PREFERRED SALESTYPE
- HIGH VOLTAGE CAPABILITY
- SURFACE-MOUNTING TO-252 (DPAK)
POWER PACKAGE IN TAPE & REEL
(SUFFIX "T4")
- ELECTRICAL SIMILAR TO TIP50

APPLICATIONS

- SWITCH MODE POWER SUPPLIES
- AUDIO AMPLIFIERS
- GENERAL PURPOSE SWITCHING AND
AMPLIFIER

DESCRIPTION

The MJD50 is manufactured using Medium Voltage Epitaxial Planar technology, resulting in a rugged high performance cost-effective transistor.

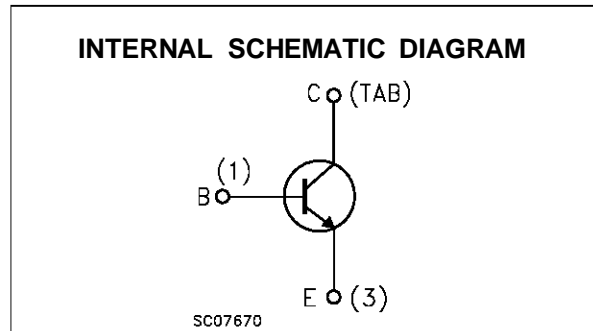
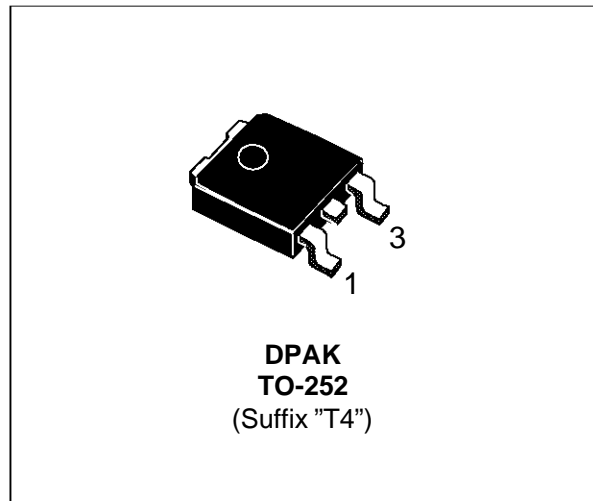

ABSOLUTE MAXIMUM RATINGS

Symbol	Parameter	Value	Unit
V_{CBO}	Collector-Base Voltage ($I_E = 0$)	500	V
V_{CEO}	Collector-Emitter Voltage ($I_B = 0$)	400	V
V_{EBO}	Emitter-Base Voltage ($I_C = 0$)	5	V
I_C	Collector Current	1	A
I_{CM}	Collector Peak Current ($t_p < 5$ ms)	2	A
I_B	Base Current	0.6	A
I_{BM}	Base Peak Current ($t_p < 5$ ms)	1.2	A
P_{tot}	Total Dissipation at $T_C = 25$ °C	15	W
T_{stg}	Storage Temperature	-65 to 150	°C
T_j	Max. Operating Junction Temperature	150	°C

MJD50

THERMAL DATA

R _{thj-case}	Thermal Resistance Junction-case	Max	8.33	°C/W
R _{thj-amb}	Thermal Resistance Junction-ambient	Max	100	°C/W

ELECTRICAL CHARACTERISTICS (T_{case} = 25 °C unless otherwise specified)

Symbol	Parameter	Test Conditions	Min.	Typ.	Max.	Unit
I _{CES}	Collector Cut-off Current (V _{BE} = 0)	V _{CE} = 500 V			0.1	mA
I _{CEO}	Collector Cut-off Current (I _B = 0)	V _{CE} = 300 V			0.1	mA
I _{EBO}	Emitter Cut-off Current (I _C = 0)	V _{EB} = 5 V			1	mA
V _{CEO(sus)}	Collector-Emitter Sustaining Voltage	I _C = 30 mA	400			V
V _{CE(sat)*}	Collector-Emitter Saturation Voltage	I _C = 1 A I _B = 0.2 A			1	V
V _{BE(on)*}	Base-Emitter On Voltage	I _C = 1 A V _{CE} = 10 V			1.5	V
h _{FE*}	DC Current Gain	I _C = 0.3 A V _{CE} = 10 V I _C = 1 A V _{CE} = 10 V	30 10		150	
f _T	Transition Frequency	I _C = 0.2 A V _{CE} = 10 V f=2MHz	10			MHz
h _{fe}	Small Signal Current Gain	I _C = 0.2 A V _{CE} = 10 V f=1kHz	25			

* Pulsed: Pulse duration = 300 μs, duty cycle 1.5 %

Safe Operating Area

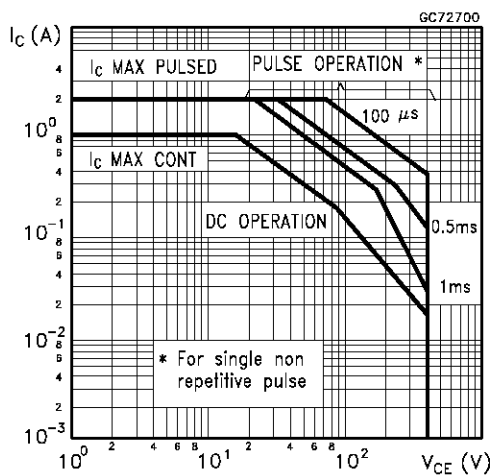

Derating Curves

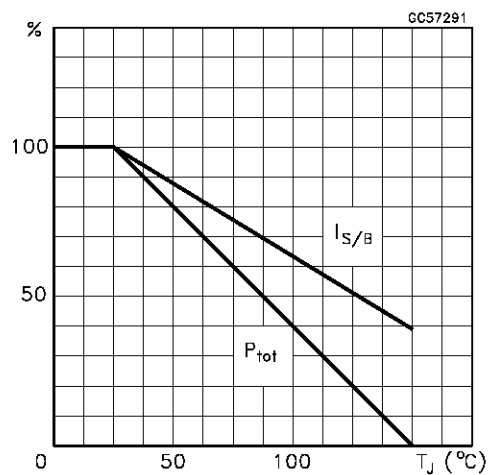

DC Current Gain

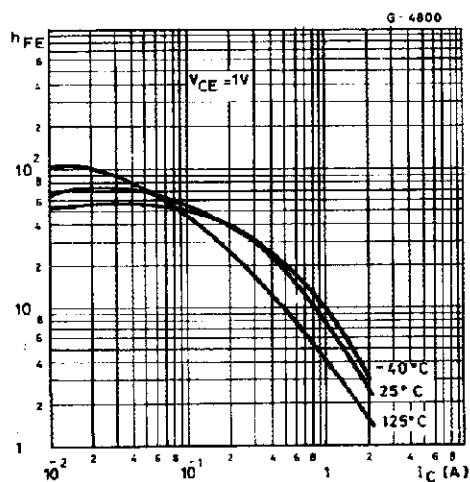

DC Current Gain

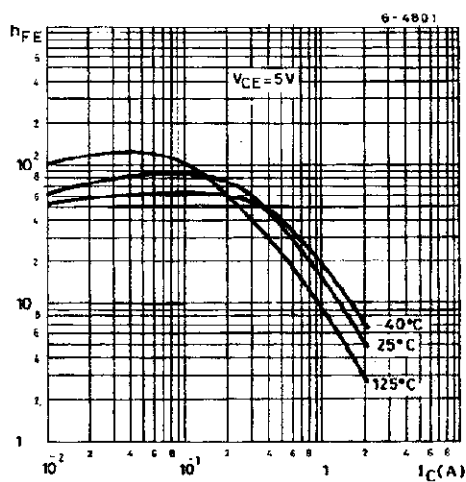

Collector-Emitter Saturation Voltage

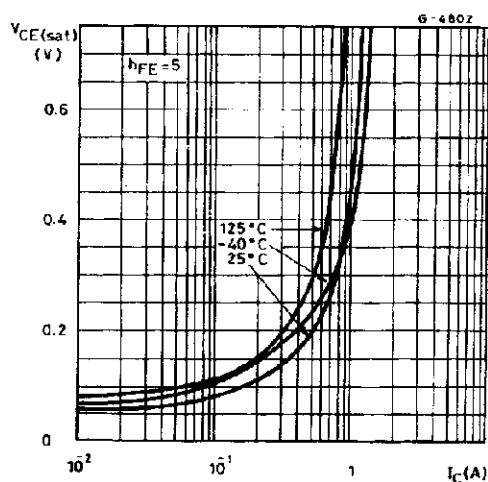

Collector-Emitter Saturation Voltage

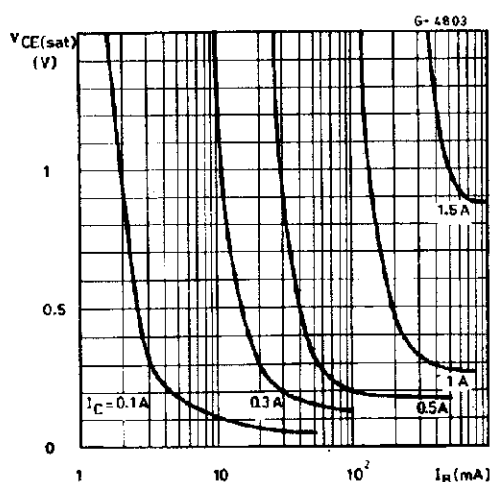

Base-Emitter Saturation Voltage

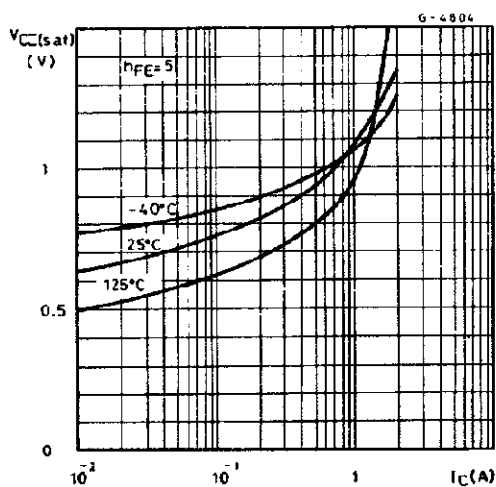

Collector-Base Capacitance

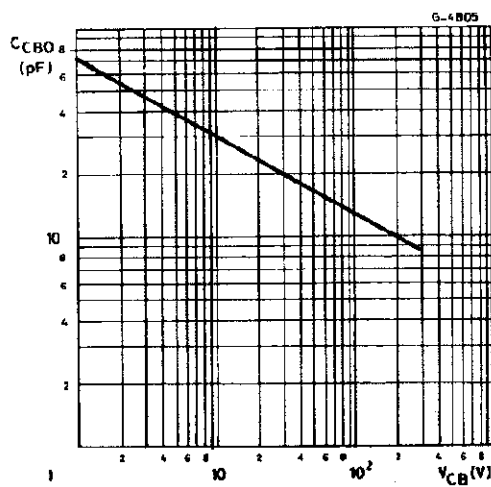

Switching Time Inductive Load

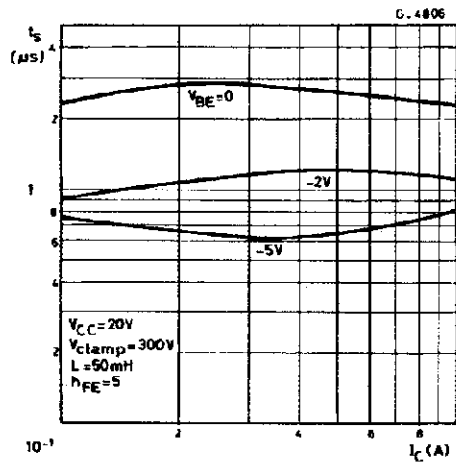

Switching Time Inductive Load

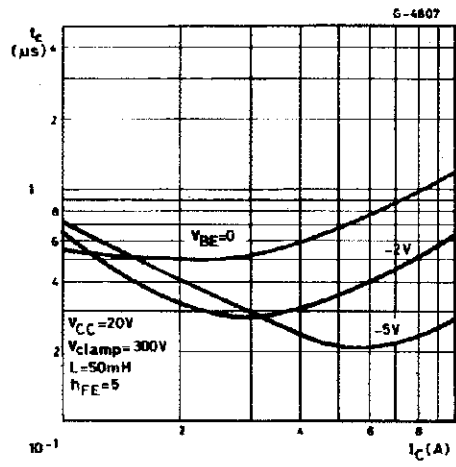

Switching Time Inductive Load

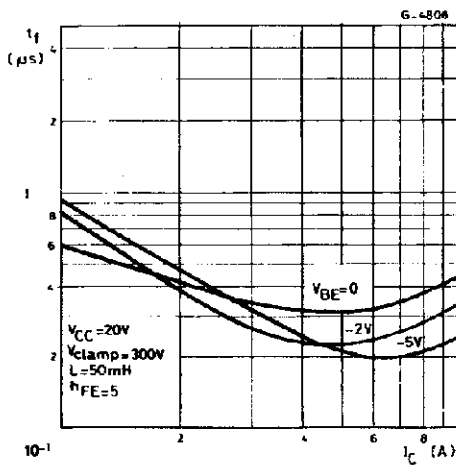

Switching Time Inductive Load

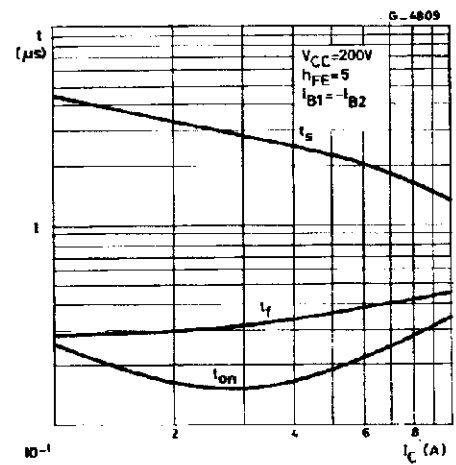

TO-252 (DPAK) MECHANICAL DATA

DIM.	mm			inch		
	MIN.	TYP.	MAX.	MIN.	TYP.	MAX.
A	2.2		2.4	0.086		0.094
A1	0.9		1.1	0.035		0.043
A2	0.03		0.23	0.001		0.009
B	0.64		0.9	0.025		0.035
B2	5.2		5.4	0.204		0.212
C	0.45		0.6	0.017		0.023
C2	0.48		0.6	0.019		0.023
D	6		6.2	0.236		0.244
E	6.4		6.6	0.252		0.260
G	4.4		4.6	0.173		0.181
H	9.35		10.1	0.368		0.397
L2		0.8			0.031	
L4	0.6		1	0.023		0.039

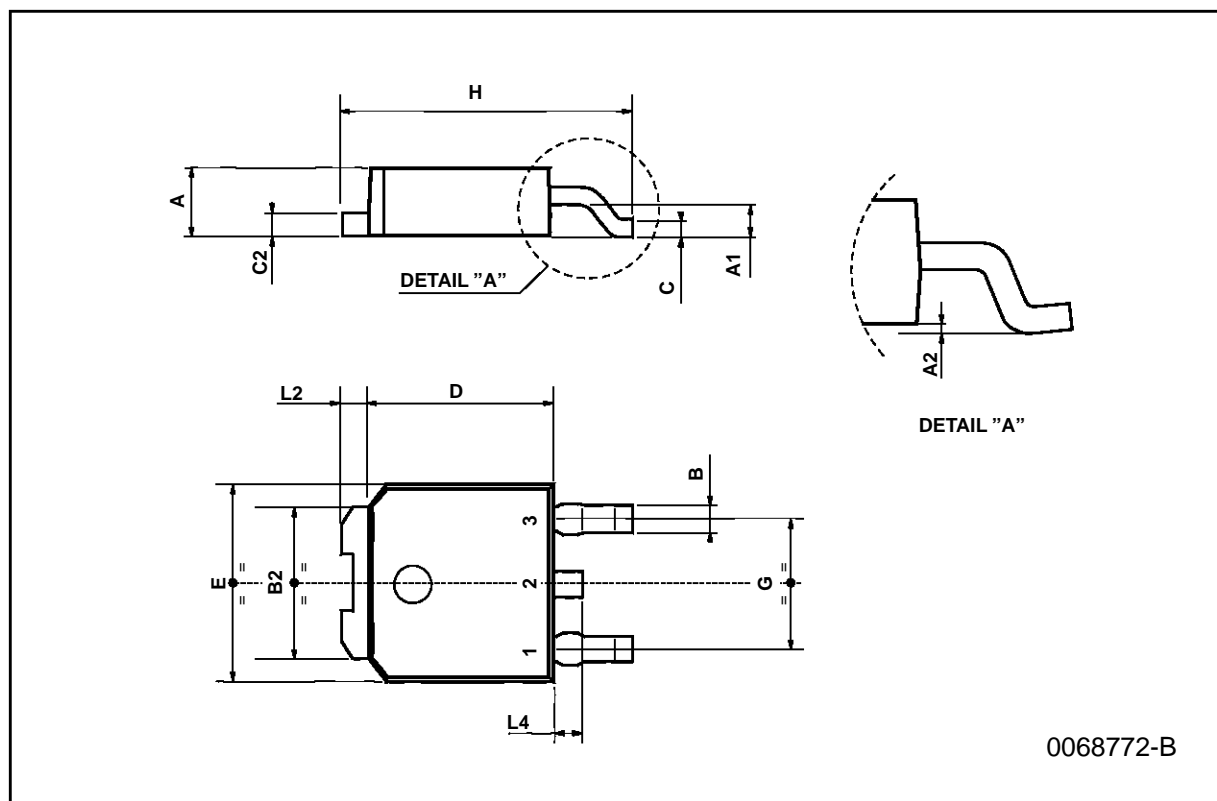

Information furnished is believed to be accurate and reliable. However, SGS-THOMSON Microelectronics assumes no responsibility for the consequences of use of such information nor for any infringement of patents or other rights of third parties which may result from its use. No license is granted by implication or otherwise under any patent or patent rights of SGS-THOMSON Microelectronics. Specifications mentioned in this publication are subject to change without notice. This publication supersedes and replaces all information previously supplied. SGS-THOMSON Microelectronics products are not authorized for use as critical components in life support devices or systems without express written approval of SGS-THOMSON Microelectronics.

© 1997 SGS-THOMSON Microelectronics - Printed in Italy - All Rights Reserved

SGS-THOMSON Microelectronics GROUP OF COMPANIES
Australia - Brazil - Canada - China - France - Germany - Hong Kong - Italy - Japan - Korea - Malaysia - Malta - Morocco - The Netherlands -
Singapore - Spain - Sweden - Switzerland - Taiwan - Thailand - United Kingdom - U.S.A
...