

General purpose (dual digital transistors)

UMD3N / IMD3A

●Features

- 1) Both the DTA114E chip and DTC114E chip in a UMT or SMT package.
- 2) Mounting possible with UMT3 or SMT3 automatic mounting machines.
- 3) Transistor elements are independent, eliminating interference.
- 4) Mounting cost and area can be cut in half.

●Structure

Epitaxial planar type
NPN/PNP silicon transistor
(Built-in resistor type)

The following characteristics apply to both DT_{R1} and DT_{R2}, however, the “-” sign on DT_{R2} values for the PNP type have been omitted.

●External dimensions (Units: mm)

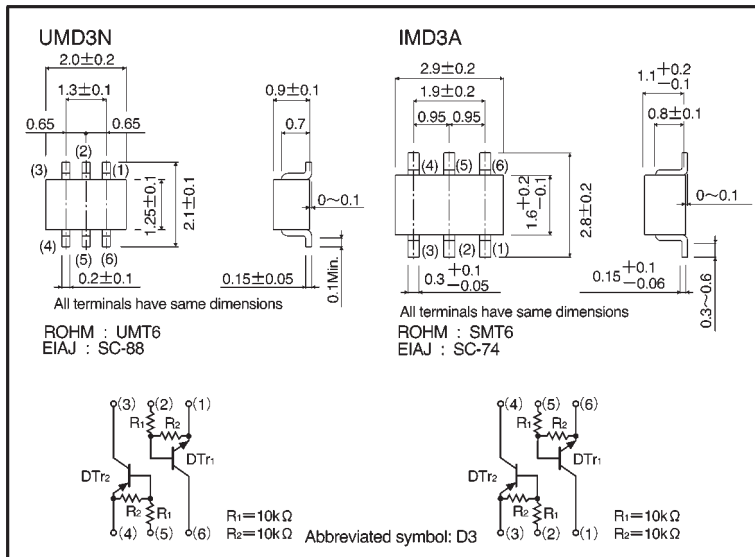

●Absolute maximum ratings (Ta = 25°C)

Parameter	Symbol	Limits	Unit
Supply voltage	V _{CC}	50	V
Input voltage	V _{IN}	-10	V
		40	
Output current	I _O	50	mA
	I _{C(Max.)}	100	
Power dissipation	UMD3N	150 (TOTAL)	mW *1
	IMD3A	300 (TOTAL)	mW *2
Junction temperature	T _J	150	°C
Storage temperature	T _{stg}	-55~+150	°C

*1 120mW per element must not be exceeded.

*2 200mW per element must not be exceeded.

●Electrical characteristics (Ta = 25°C)

Parameter	Symbol	Min.	Typ.	Max.	Unit	Conditions
Input voltage	$V_{I(off)}$	—	—	0.5	V	$V_{CC}=5V, I_o=100\mu A$
	$V_{I(on)}$	3	—	—		$V_o=0.3V, I_o=10mA$
Output voltage	$V_{O(on)}$	—	0.1	0.3	V	$I_o=10mA, I_i=0.5mA$
Input current	I_i	—	—	0.88	mA	$V_i=5V$
Output current	$I_{O(off)}$	—	—	0.5	μA	$V_{CC}=50V, V_i=0V$
DC current gain	G_i	30	—	—	—	$V_o=5V, I_o=5mA$
Transition frequency	f_T	—	250	—	MHz	$V_{CE}=10mA, I_E=-5mA, f=100MHz *$
Input resistance	R_i	7	10	13	k Ω	—
Resistance ratio	R_2/R_1	0.8	1	1.2	—	—

* Transition frequency of the device

●Packaging specifications

Part No.	Packaging type	Taping	
	Code	TR	T108
	Basic ordering unit (pieces)	3000	3000
UMD3N		○	—
IMD3A		—	○

●Electrical characteristic curves
DT_{T1} (NPN)

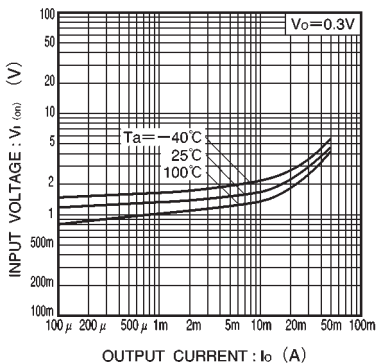

Fig.1 Input voltage vs. output current (ON characteristics)

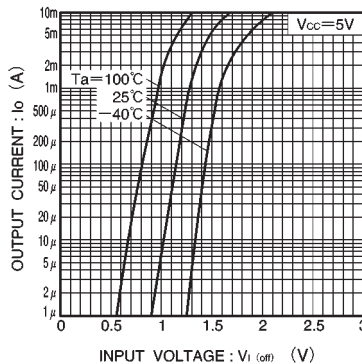

Fig.2 Output current vs. input voltage (OFF characteristics)

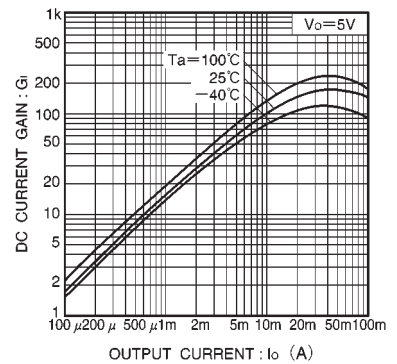

Fig.3 DC current gain vs. output current

DTr₂ (PNP)

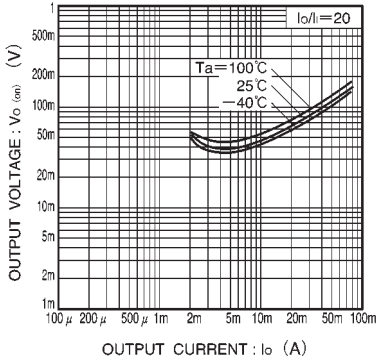

Fig.4 Output voltage vs. output current

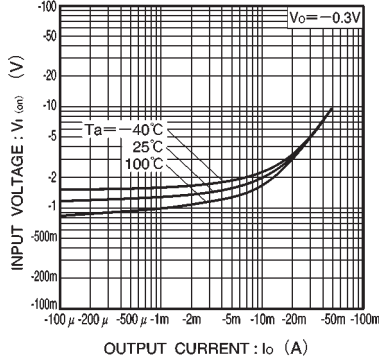

Fig.5 Input voltage vs. output current (ON characteristics)

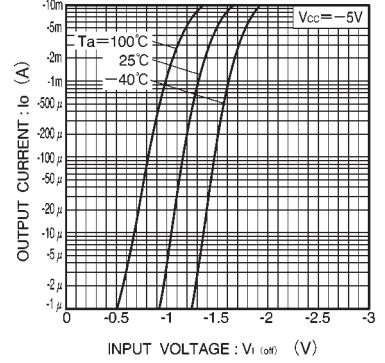

Fig.6 Output current vs. input voltage (OFF characteristics)

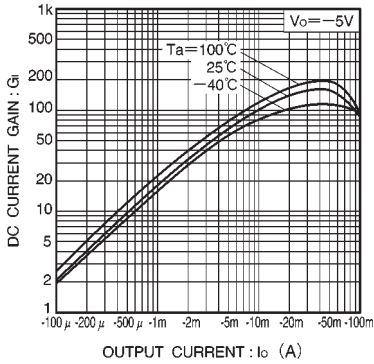

Fig.7 DC current gain vs. output current

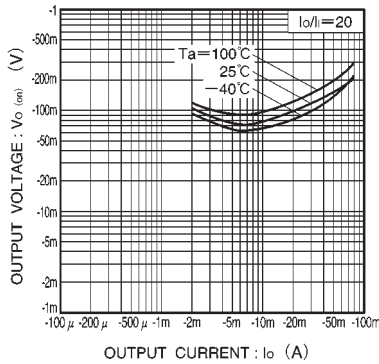

Fig.8 Output voltage vs. output current