

2SK366

For Audio Amplifier, Analog-Switch, Constant Current and Impedance Converter Applications

Unit: mm

- High voltage: $V_{GDS} = -40\text{ V}$
- High input impedance: $I_{GSS} = -1.0\text{ nA (max)}$ ($V_{GS} = -30\text{ V}$)
- Low $R_{DS(ON)}$: $R_{DS(ON)} = 50\ \Omega$ (typ.) ($I_{DSS} = 5\text{ mA}$)
- Small package
- Complementary to 2SJ107

Maximum Ratings ($T_a = 25^\circ\text{C}$)

Characteristics	Symbol	Rating	Unit
Gate-drain voltage	V_{GDS}	-40	V
Gate current	I_G	10	mA
Drain power dissipation	P_D	200	mW
Junction temperature	T_j	125	$^\circ\text{C}$
Storage temperature range	T_{stg}	-55~125	$^\circ\text{C}$

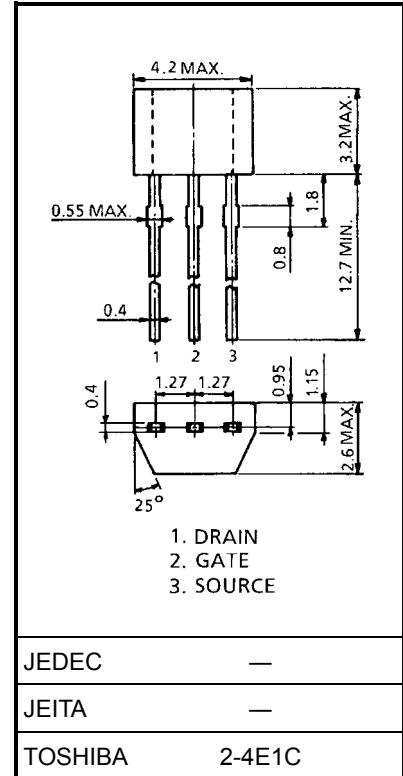

Electrical Characteristics ($T_a = 25^\circ\text{C}$)

Weight: 0.13 g (typ.)

Characteristics	Symbol	Test Condition	Min	Typ.	Max	Unit
Gate cut-off current	I_{GSS}	$V_{GS} = -30\text{ V}, V_{DS} = 0$	—	—	-1.0	nA
Gate-drain breakdown voltage	$V_{(BR)GDS}$	$V_{DS} = 0, I_C = -100\ \mu\text{A}$	-40	—	—	V
Drain current	I_{DSS} (Note 1)	$V_{DS} = 10\text{ V}, V_{GS} = 0$	2.6	—	20	mA
Gate-source cut-off voltage	$V_{GS(OFF)}$	$V_{DS} = 10\text{ V}, I_D = 0.1\ \mu\text{A}$	-0.2	—	-1.5	V
Forward transfer admittance	$ Y_{fs} $	$V_{DS} = 10\text{ V}, V_{GS} = 0, f = 1\text{ kHz}$ (Note 2)	12	28	—	mS
Input capacitance	C_{iss}	$V_{DS} = 10\text{ V}, V_{GS} = 0, f = 1\text{ MHz}$	—	30	—	pF
Reverse transfer capacitance	C_{rss}	$V_{DG} = 10\text{ V}, I_D = 0, f = 1\text{ MHz}$	—	6	—	pF
Drain-source ON resistance	$R_{DS(ON)}$	$V_{DS} = 10\text{ mV}, V_{GS} = 0$ (Note 2)	—	50	—	Ω

Note 1: I_{DSS} classification GR: 2.6~6.5 mA, BL: 6~12 mA, V: 10~20 mA

Note 2: Condition of the typical value $I_{DSS} = 5\text{ mA}$

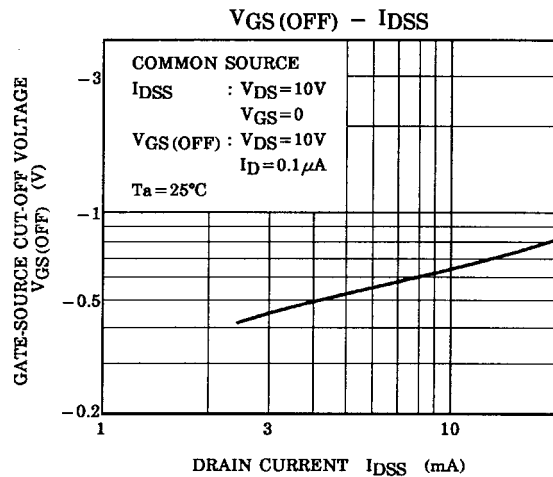
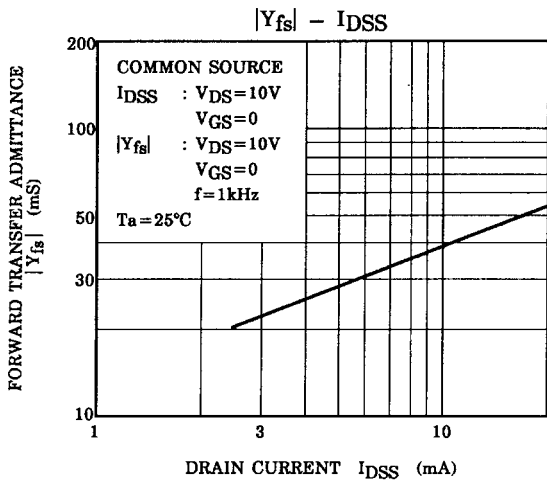
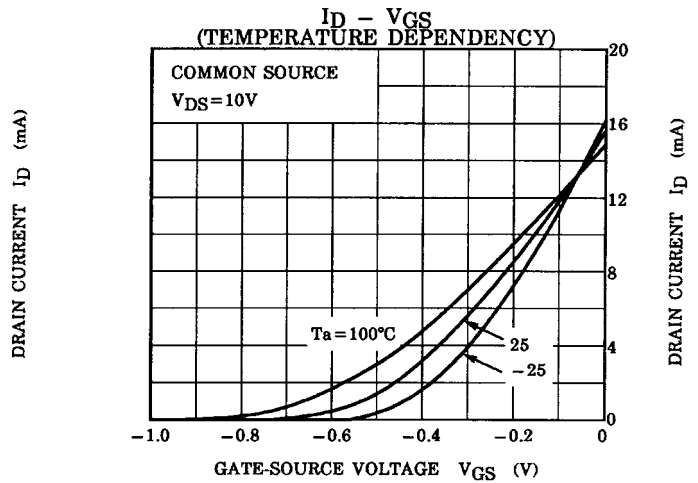
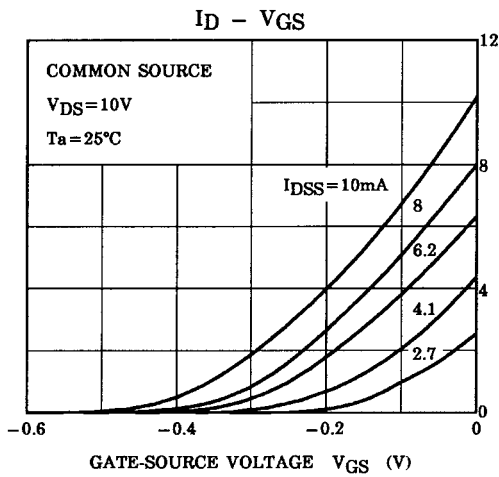
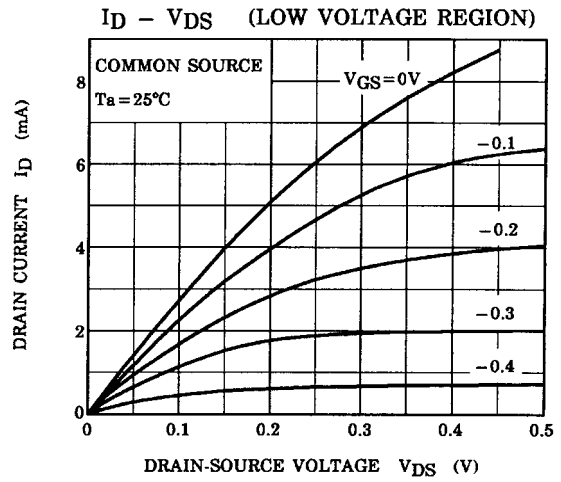
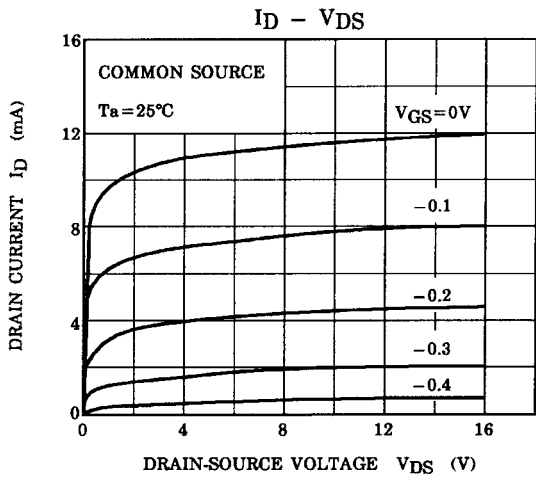

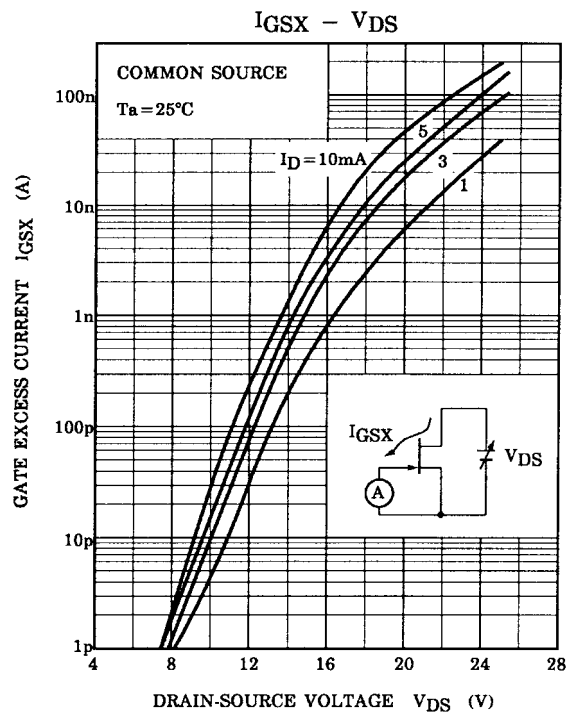
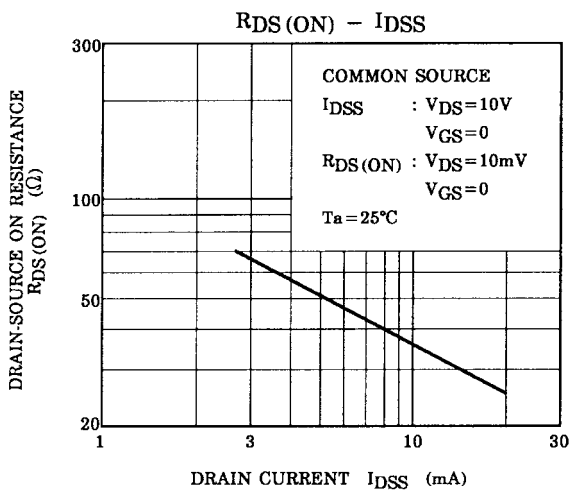
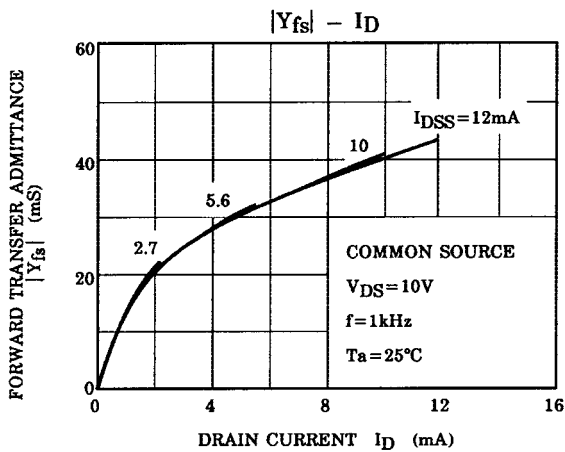
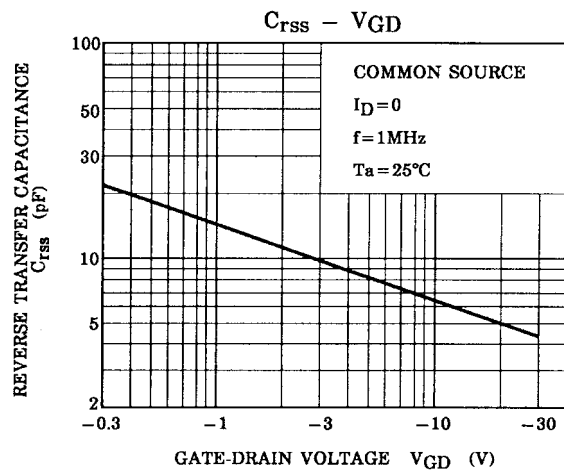
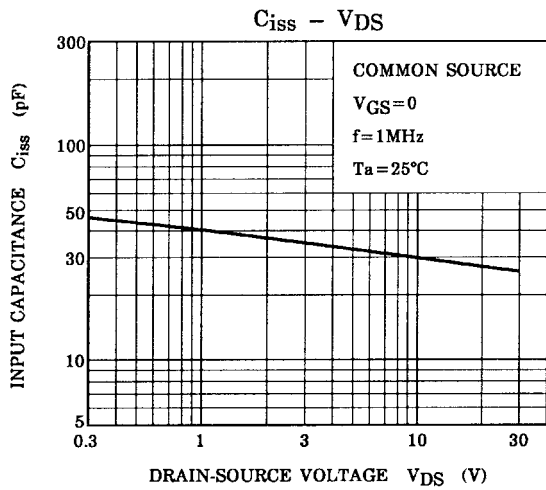

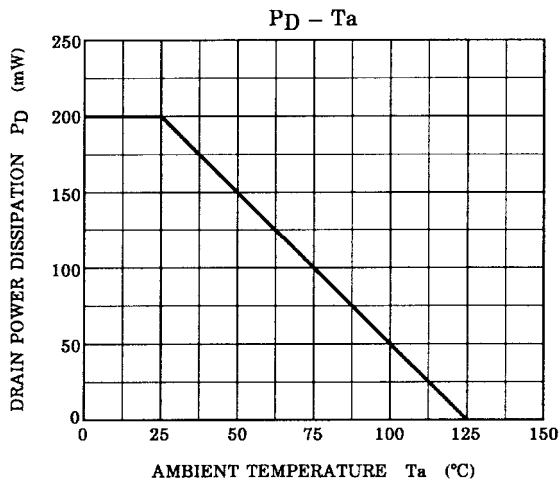
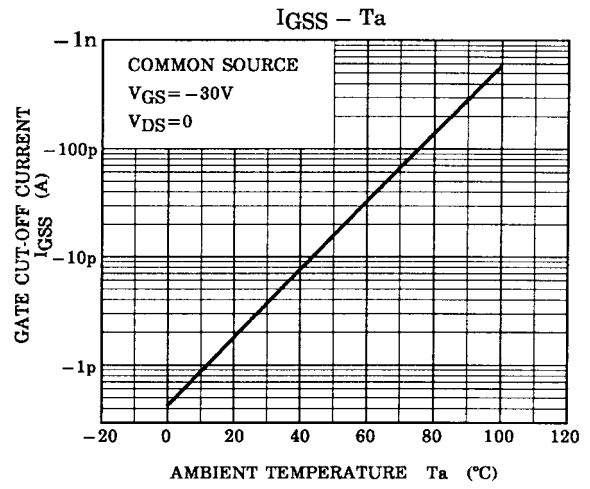
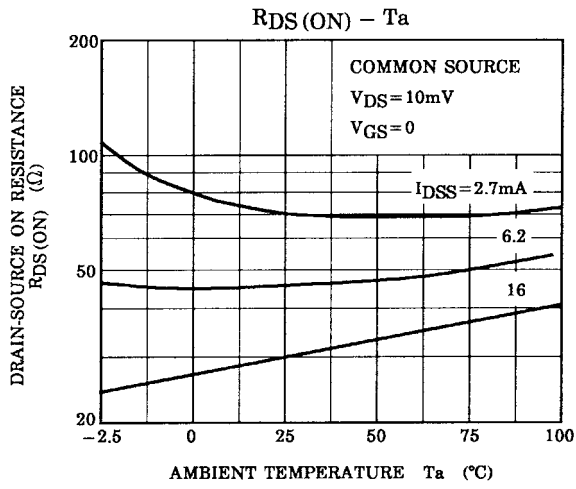

RESTRICTIONS ON PRODUCT USE

000707EAA

- TOSHIBA is continually working to improve the quality and reliability of its products. Nevertheless, semiconductor devices in general can malfunction or fail due to their inherent electrical sensitivity and vulnerability to physical stress. It is the responsibility of the buyer, when utilizing TOSHIBA products, to comply with the standards of safety in making a safe design for the entire system, and to avoid situations in which a malfunction or failure of such TOSHIBA products could cause loss of human life, bodily injury or damage to property.
In developing your designs, please ensure that TOSHIBA products are used within specified operating ranges as set forth in the most recent TOSHIBA products specifications. Also, please keep in mind the precautions and conditions set forth in the "Handling Guide for Semiconductor Devices," or "TOSHIBA Semiconductor Reliability Handbook" etc..
- The TOSHIBA products listed in this document are intended for usage in general electronics applications (computer, personal equipment, office equipment, measuring equipment, industrial robotics, domestic appliances, etc.). These TOSHIBA products are neither intended nor warranted for usage in equipment that requires extraordinarily high quality and/or reliability or a malfunction or failure of which may cause loss of human life or bodily injury ("Unintended Usage"). Unintended Usage include atomic energy control instruments, airplane or spaceship instruments, transportation instruments, traffic signal instruments, combustion control instruments, medical instruments, all types of safety devices, etc.. Unintended Usage of TOSHIBA products listed in this document shall be made at the customer's own risk.
- The information contained herein is presented only as a guide for the applications of our products. No responsibility is assumed by TOSHIBA CORPORATION for any infringements of intellectual property or other rights of the third parties which may result from its use. No license is granted by implication or otherwise under any intellectual property or other rights of TOSHIBA CORPORATION or others.
- The information contained herein is subject to change without notice.