2SK2796 (L), 2SK2796 (S)

Silicon N Channel MOS FET
High Speed Power Switching

HITACHI

ADE-208-534 A
2nd. Edition

Features

- Low on-resistance
 $R_{DS(on)} = 0.12\Omega$ typ.
- 4V gate drive devices.
- High speed switching

Outline

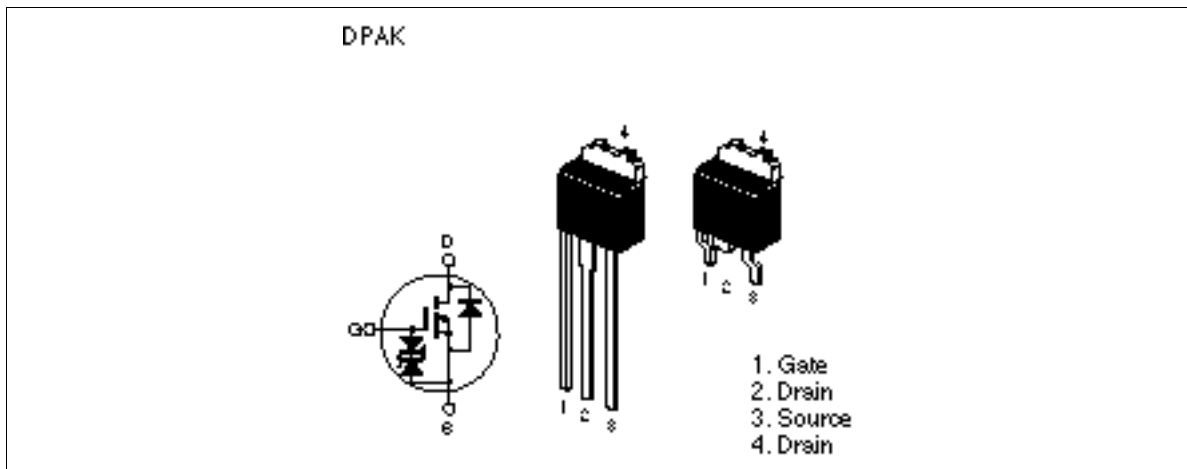

2SK2796 (L), 2SK2796 (S)

Absolute Maximum Ratings (Ta = 25°C)

Item	Symbol	Ratings	Unit
Drain to source voltage	V _{DSS}	60	V
Gate to source voltage	V _{GSS}	±20	V
Drain current	I _D	5	A
Drain peak current	I _{D(pulse)} * ¹	20	A
Body to drain diode reverse drain current	I _{DR}	5	A
Avalanche current	I _{AP} * ³	5	A
Avalanche energy	E _{AR} * ³	2.14	mJ
Channel dissipation	P _{ch} * ²	20	W
Channel temperature	T _{ch}	150	°C
Storage temperature	T _{stg}	-55 to +150	°C

Notes: 1. PW ≤ 10μs, duty cycle ≤ 1 %

2. Value at T_c = 25°C

3. Value at T_{ch} = 25°C, R_g = 50 Ω

2SK2796 (L), 2SK2796 (S)

Electrical Characteristics (Ta = 25°C)

Item	Symbol	Min	Typ	Max	Unit	Test Conditions
Drain to source breakdown voltage	$V_{(BR)DSS}$	60	—	—	V	$I_D = 10\text{mA}$, $V_{GS} = 0$
Gate to source breakdown voltage	$V_{(BR)GSS}$	± 20	—	—	V	$I_G = \pm 100\mu\text{A}$, $V_{DS} = 0$
Zero gate voltage drain current	I_{DSS}	—	—	10	μA	$V_{DS} = 60\text{V}$, $V_{GS} = 0$
Gate to source leak current	I_{GSS}	—	—	± 10	μA	$V_{GS} = \pm 16\text{V}$, $V_{DS} = 0$
Gate to source cutoff voltage	$V_{GS(off)}$	1.0	—	2.0	V	$I_D = 1\text{mA}$, $V_{DS} = 10\text{V}$
Static drain to source on state resistance	$R_{DS(on)}$	—	0.12	0.16	Ω	$I_D = 3\text{A}$, $V_{GS} = 10\text{V}^{*1}$
	$R_{DS(on)}$	—	0.16	0.25	Ω	$I_D = 3\text{A}$, $V_{GS} = 4\text{V}^{*1}$
Forward transfer admittance	$ y_{fs} $	2.5	4.0	—	S	$I_D = 3\text{A}$, $V_{DS} = 10\text{V}^{*1}$
Input capacitance	C_{iss}	—	180	—	pF	$V_{DS} = 10\text{V}$
Output capacitance	C_{oss}	—	90	—	pF	$V_{GS} = 0$
Reverse transfer capacitance	C_{rss}	—	30	—	pF	$f = 1\text{MHz}$
Turn-on delay time	$t_{d(on)}$	—	9	—	ns	$V_{GS} = 10\text{V}$, $I_D = 3\text{A}$
Rise time	t_r	—	25	—	ns	$R_L = 12\Omega$
Turn-off delay time	$t_{d(off)}$	—	35	—	ns	
Fall time	t_f	—	55	—	ns	
Body to drain diode forward voltage	V_{DF}	—	1.0	—	V	$I_D = 5\text{A}$, $V_{GS} = 0$
Body to drain diode reverse recovery time	t_{rr}	—	40	—	ns	$I_F = 5\text{A}$, $V_{GS} = 0$ $di_F/dt = 50\text{A}/\mu\text{s}$

Note: 1. Pulse test

2SK2796 (L), 2SK2796 (S)

Main Characteristics

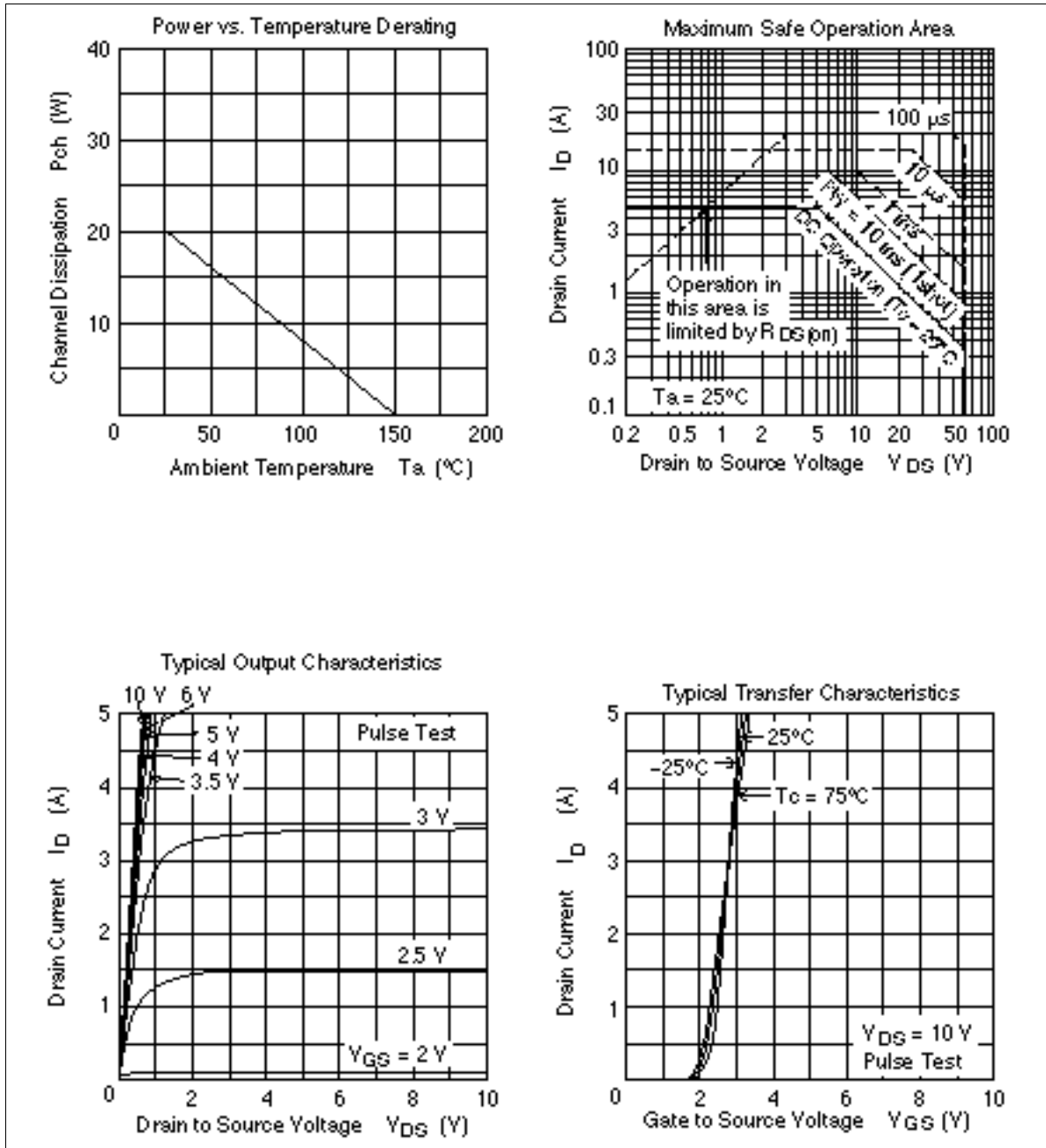

HITACHI

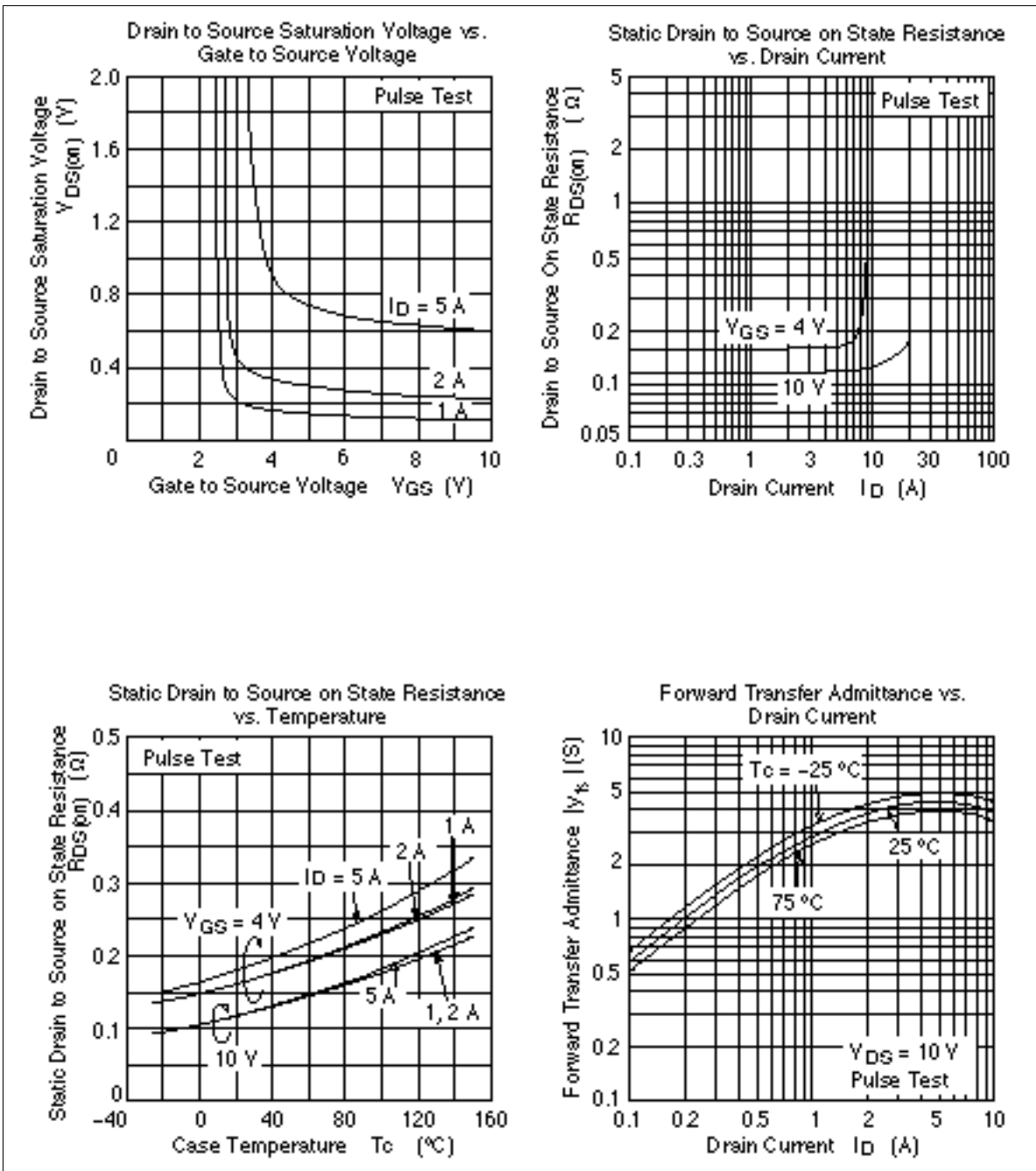

2SK2796 (L), 2SK2796 (S)

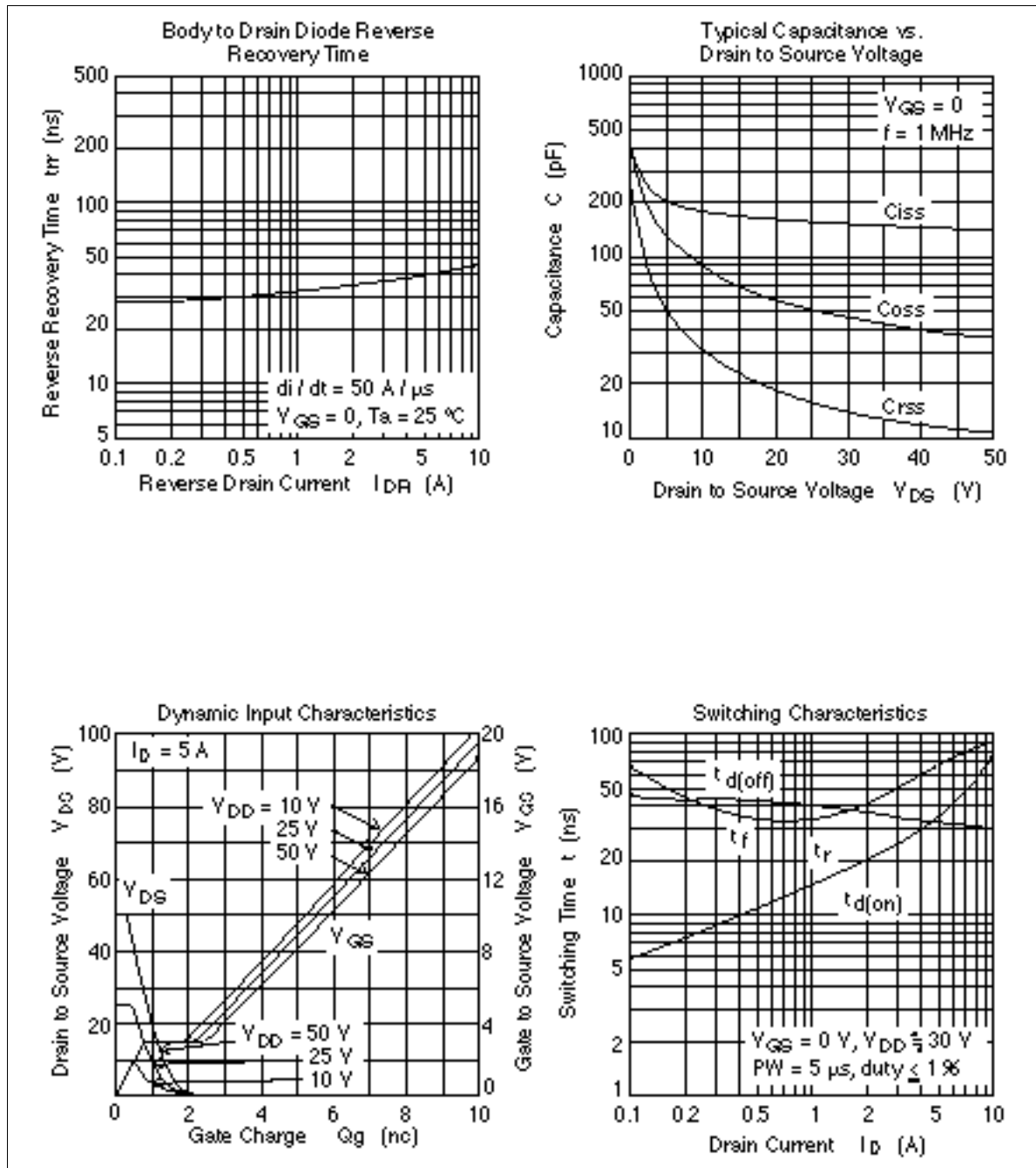

HITACHI

2SK2796 (L), 2SK2796 (S)

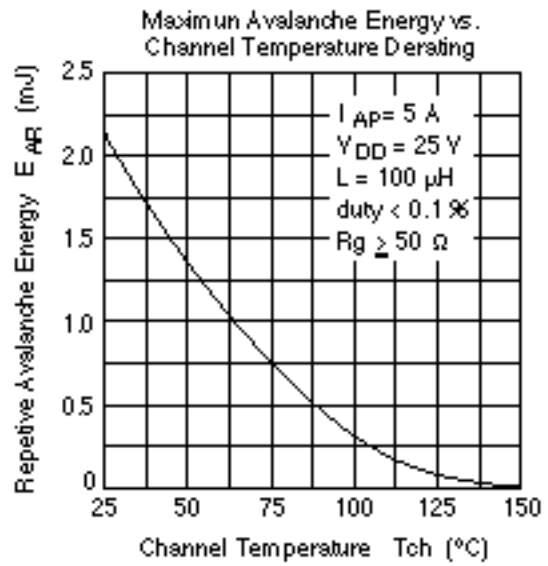
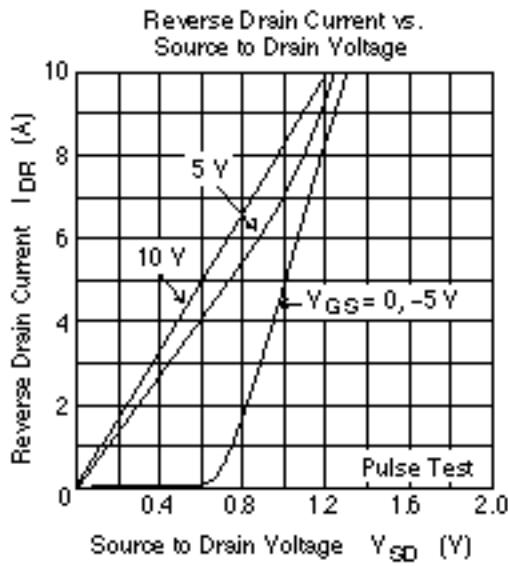

Avalanche Test Circuit

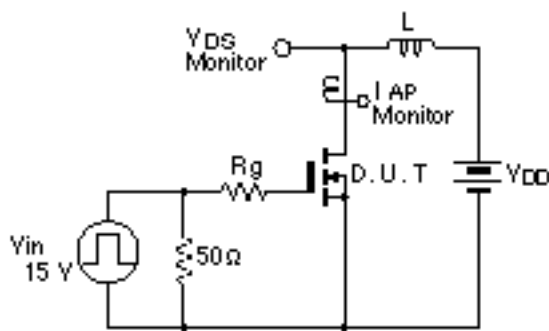

Avalanche Waveform

$$E_{AR} = \frac{1}{2} \cdot L \cdot I_{AP}^2 \cdot \frac{V_{DSS}}{V_{DSS} - V_{DD}}$$

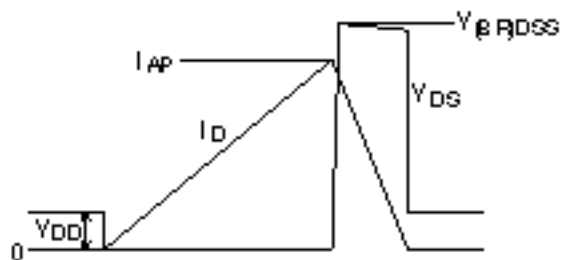

2SK2796 (L), 2SK2796 (S)

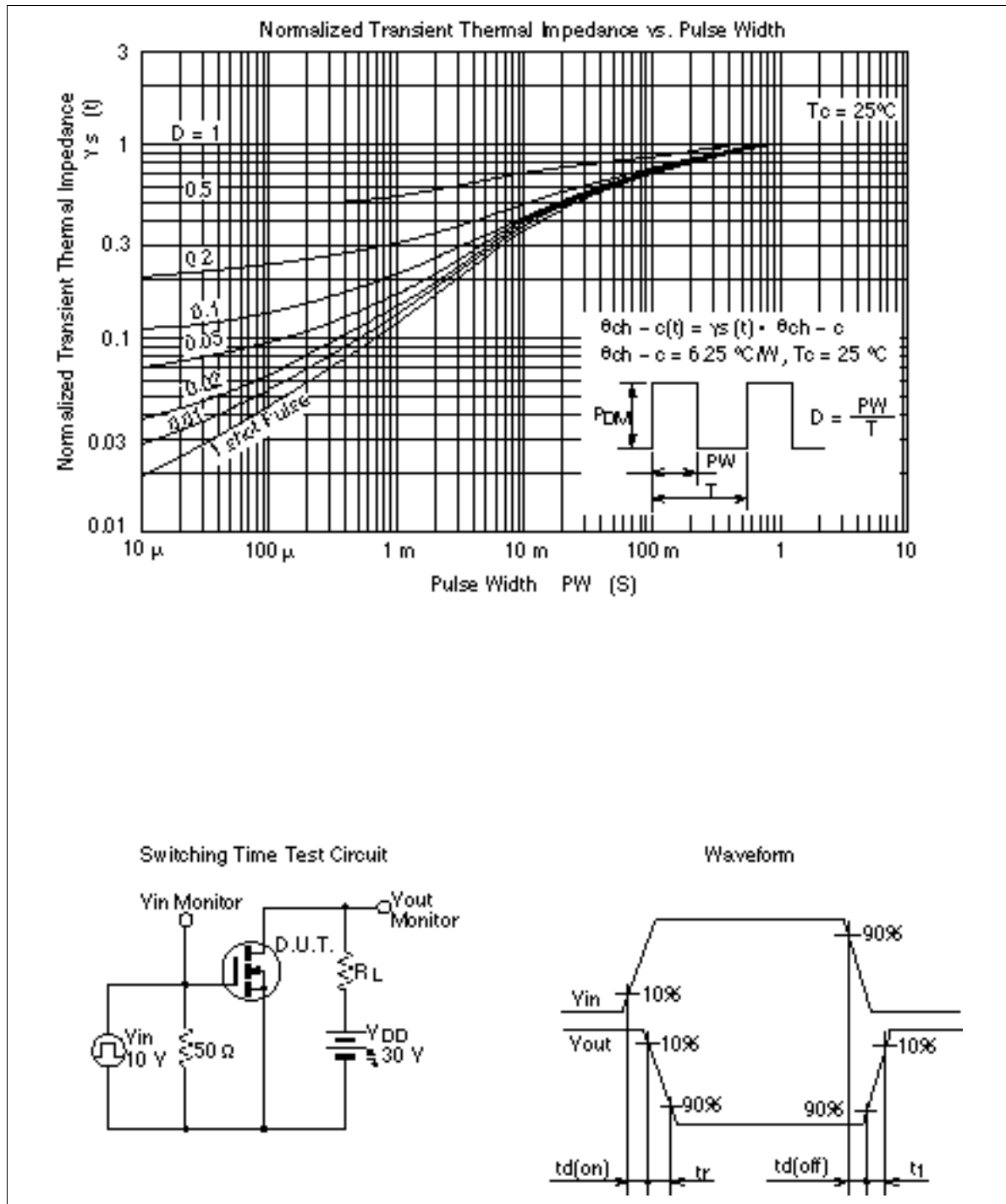

HITACHI

2SK2796 (L), 2SK2796 (S)

Package Dimensions

Unit: mm

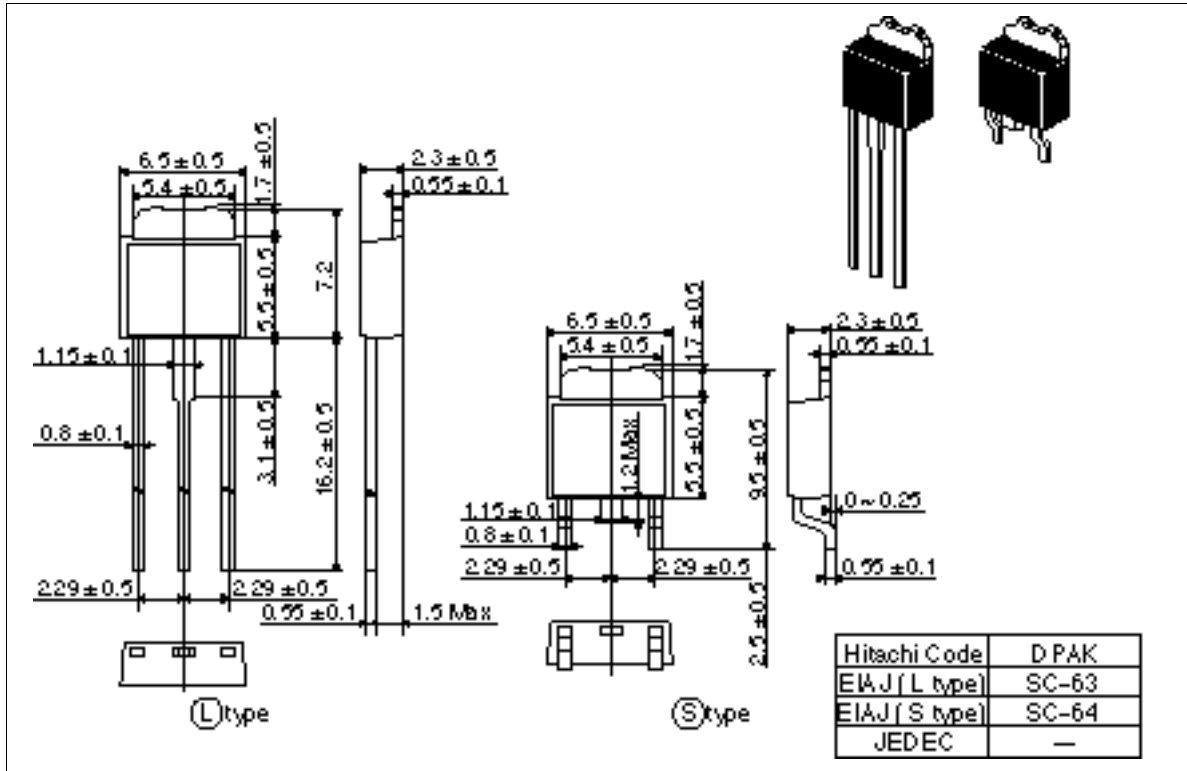

HITACHI

2SK2796 (L), 2SK2796 (S)

When using this document, keep the following in mind:

1. This document may, wholly or partially, be subject to change without notice.
2. All rights are reserved: No one is permitted to reproduce or duplicate, in any form, the whole or part of this document without Hitachi's permission.
3. Hitachi will not be held responsible for any damage to the user that may result from accidents or any other reasons during operation of the user's unit according to this document.
4. Circuitry and other examples described herein are meant merely to indicate the characteristics and performance of Hitachi's semiconductor products. Hitachi assumes no responsibility for any intellectual property claims or other problems that may result from applications based on the examples described herein.
5. No license is granted by implication or otherwise under any patents or other rights of any third party or Hitachi, Ltd.
6. **MEDICAL APPLICATIONS:** Hitachi's products are not authorized for use in **MEDICAL APPLICATIONS** without the written consent of the appropriate officer of Hitachi's sales company. Such use includes, but is not limited to, use in life support systems. Buyers of Hitachi's products are requested to notify the relevant Hitachi sales offices when planning to use the products in **MEDICAL APPLICATIONS**.

HITACHI

Hitachi, Ltd.

Semiconductor & IC Div.

Nippon Bldg., 2-5-2, Ohite-machi, Chiyoda-ku, Tokyo 100, Japan

Tel: Tokyo (03) 3270-2111

Fax: (03) 3270-5109

For further information write to:

Hitachi America, Ltd.
Semiconductor & IC Div.
2000 Sierra Point Parkway
Brisbane, CA 94005-4935
U.S.A.
Tel: 415-589-8300
Fax: 415-589-4207

Hitachi Europe GmbH
Electronic Components Group
Continental Europe
Danneberg Straße 3
D-85632 Feldkirchen
München
Tel: 089-9 91 90-0
Fax: 089-9 29 30 00

Hitachi Europe Ltd.
Electronic Components Div.
Northern Europe Headquarters
Whitebrook Park
Lower Cookham Road
Midsized
Berkshire SL5 8YA
United Kingdom
Tel: 0628-585000
Fax: 0628-779322

Hitachi Asia Pte. Ltd.
45 Collyer Quay #20-00
Hitachi Tower
Singapore 0104
Tel: 535-2100
Fax: 535-1533

Hitachi Asia (Hong Kong) Ltd.
Unit 705, North Tower,
World Finance Centre
Harbour City, Canton Road
Tsim Sha Tsui, Kowloon
Hong Kong
Tel: 27359218
Fax: 27308074

Copyright © Hitachi, Ltd., 1997. All rights reserved. Printed in Japan.

HITACHI