



# 2SA1257/2SC3143

## High-Voltage Switching, AF Power Amp, 100W Output Predriver Applications

### Features

- Very small-sized package permitting the 2SA1257/2SC3143-applied sets to be made small and slim.
- High breakdown voltage ( $V_{CEO} \geq 160V$ ).
- Small output capacitance.

### Package Dimensions

unit:mm  
2018A

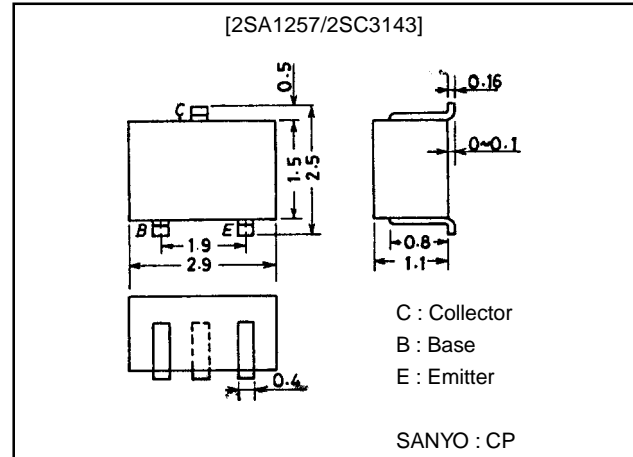

### Switching Time Test Circuit

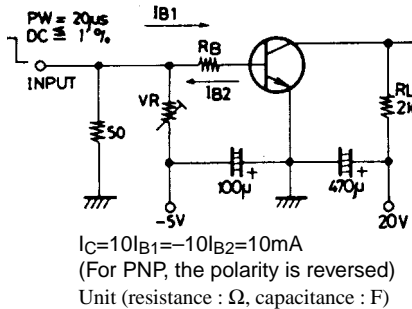

( ) : 2SA1257

### Specifications

#### Absolute Maximum Ratings at Ta = 25°C

Parameter	Symbol	Conditions	Ratings	Unit
Collector-to-Base Voltage	$V_{CBO}$		(-)180	V
Collector-to-Emitter Voltage	$V_{CEO}$		(-)160	V
Emitter-to-Base Voltage	$V_{EBO}$		(-)5	V
Collector Current	$I_C$		(-)80	mA
Collector Current Pulse	$I_{CP}$		(-)150	mA
Collector Dissipation	$P_C$		200	mW
Junction Temperature	$T_J$		125	°C
Storage Temperature	$T_{stg}$		-55 to +125	°C

#### Electrical Characteristics at Ta = 25°C

Parameter	Symbol	Conditions	Ratings			Unit
			min	typ	max	
Collector Cutoff Current	$I_{CBO}$	$V_{CB}=(-)120V, I_E=0$			(-)0.1	$\mu A$
Emitter Cutoff Current	$I_{EBO}$	$V_{EB}=(-)4V, I_C=0$			(-)0.1	$\mu A$
DC Current Gain	$h_{FE}$	$V_{CE}=(-)5V, I_C=(-)10mA$	60*		270*	
Gain-Bandwidth Product	$f_T$	$V_{CE}=(-)10V, I_C=(-)10mA$		(130) 150		MHz
Output Capacitance	$C_{ob}$	$V_{CB}=(-)10V, f=1MHz$		(2.4) 2.0	(3.2) 2.8	pF
Base-to-Emitter Voltage	$V_{BE}$	$V_{CE}=(-)5V, I_C=(-)10mA$			(-)1.5	V
Collector-to-Emitter Saturation Voltage	$V_{CE(sat)}$	$I_C=(-)30mA, I_B=(-)3mA$			(-)0.7	V
Collector-to-Base Breakdown Voltage	$V_{(BR)CBO}$	$I_C=(-)10\mu A, I_E=0$	(-)180			V
Collector-to-Emitter Breakdown Voltage	$V_{(BR)CEO}$	$I_C=(-)1mA, R_{BE}=\infty$	(-)160			V
Emitter-to-Base Breakdown Voltage	$V_{(BR)EBO}$	$I_E=(-)10\mu A, I_C=0$	(-)5			V
Turn-ON Time	$t_{on}$	See specified Test Circuit		(0.15) 0.18		$\mu s$
Storage Time	$t_{stg}$	See specified Test Circuit		(0.95) 1.00		$\mu s$
Fall Time	$t_f$	See specified Test Circuit		(0.15) 0.20		$\mu s$

\* : The 2SA1257/2SC3143 are classified by 10mA  $h_{FE}$  as follows :

60	G3	120	90	G4	180	135	G5	270
----	----	-----	----	----	-----	-----	----	-----

Marking 2SA1257 : G, 2SC3143 : K,  $h_{FE}$  rank : 3, 4, 5

**SANYO Electric Co., Ltd. Semiconductor Business Headquarters**

TOKYO OFFICE Tokyo Bldg., 1-10, 1 Chome, Ueno, Taito-ku, TOKYO, 110-8534 JAPAN

2SA1257/2SC3143

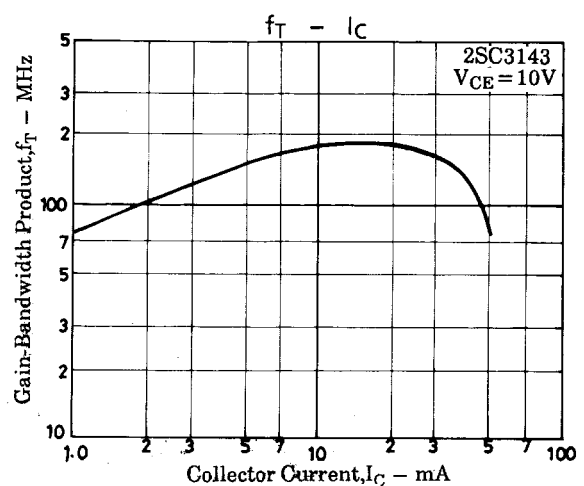
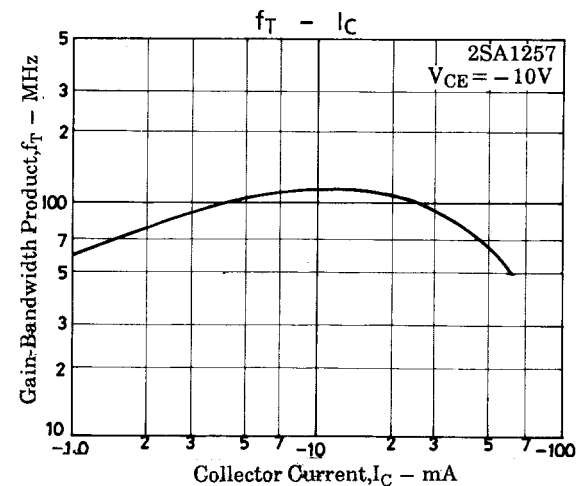
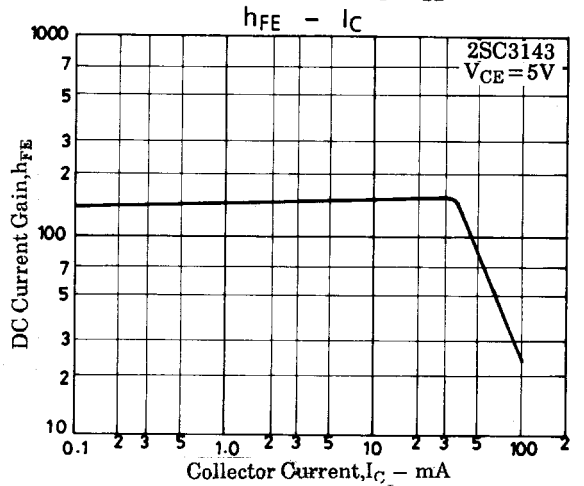
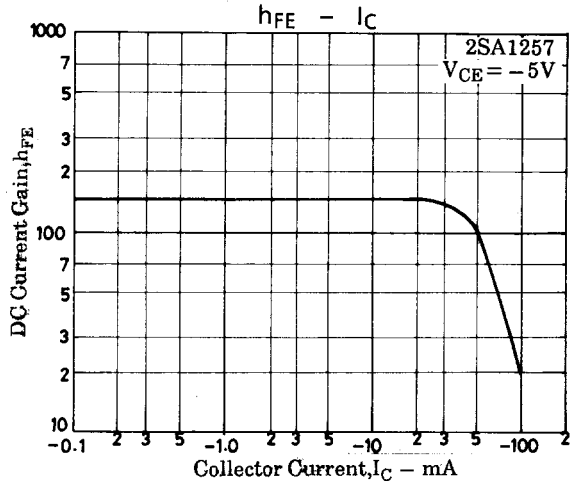
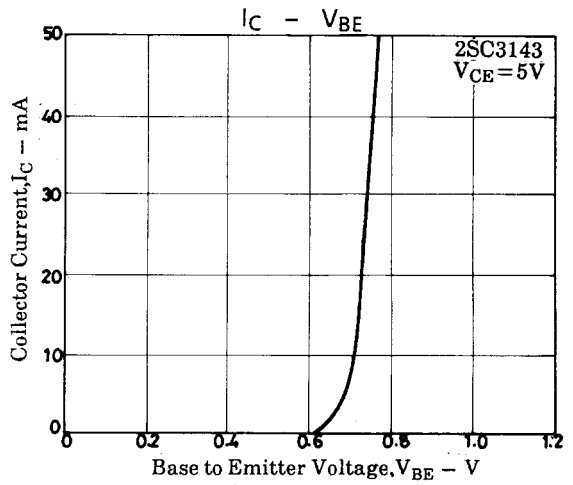
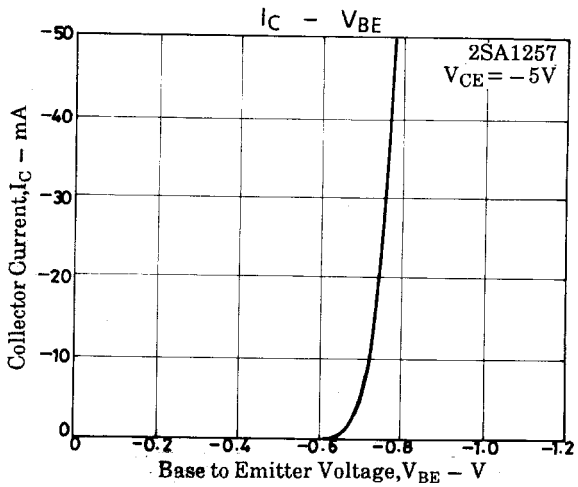
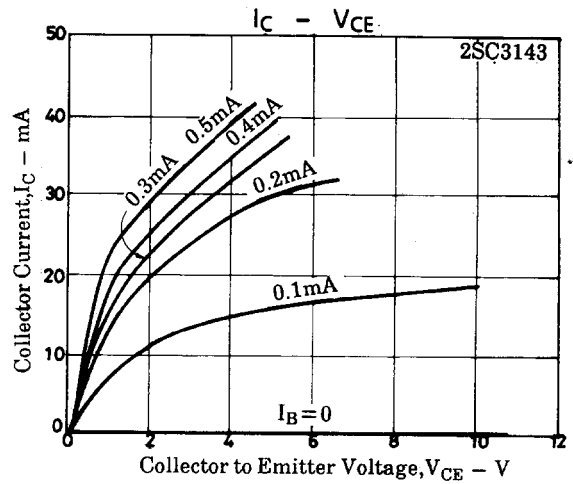
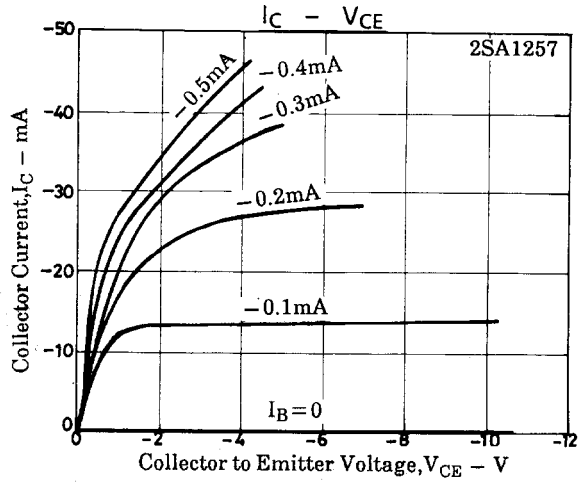

# 2SA1257/2SC3143

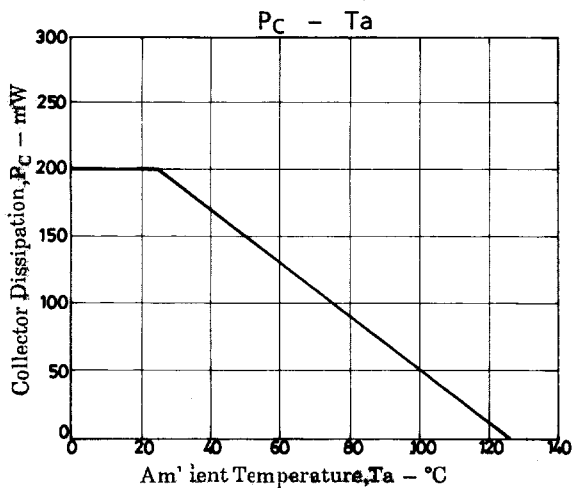
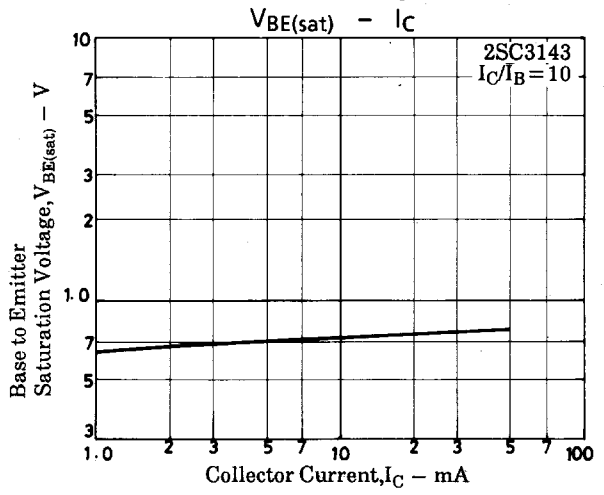
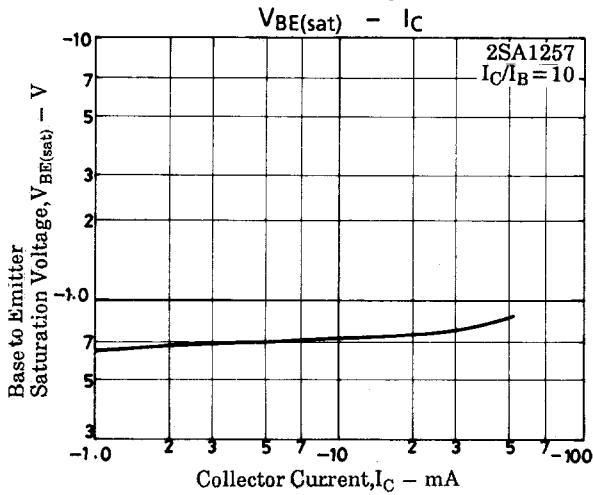
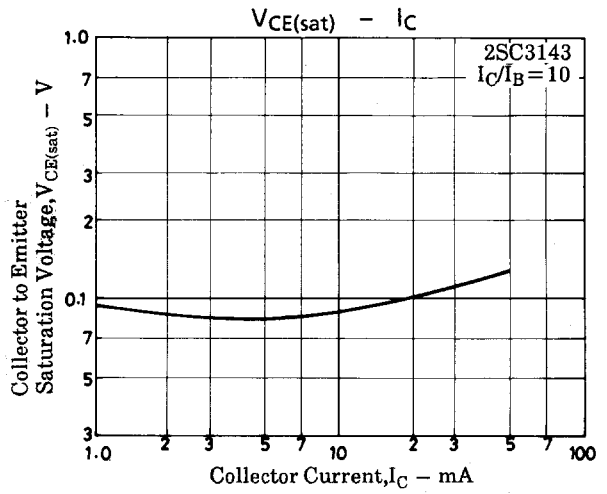
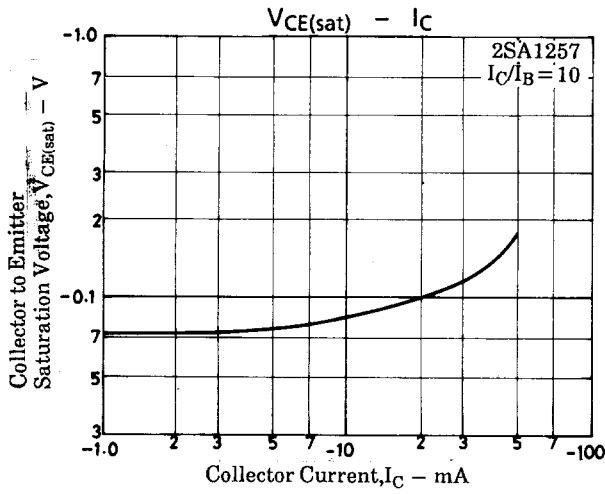
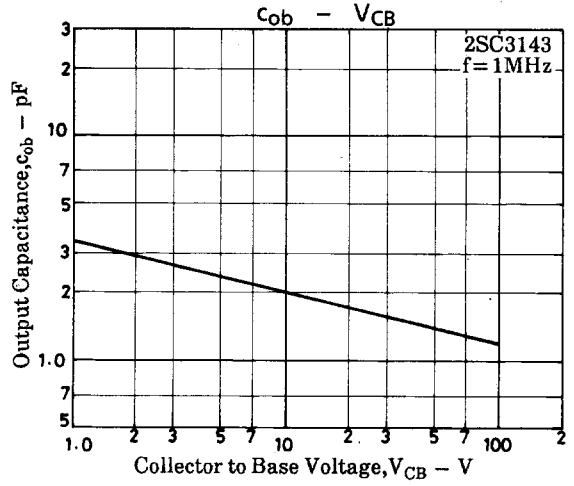
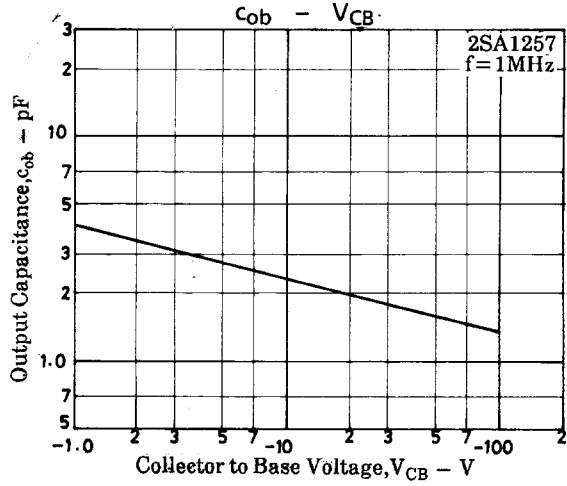

- No products described or contained herein are intended for use in surgical implants, life-support systems, aerospace equipment, nuclear power control systems, vehicles, disaster/crime-prevention equipment and the like, the failure of which may directly or indirectly cause injury, death or property loss.
- Anyone purchasing any products described or contained herein for an above-mentioned use shall:
  - ① Accept full responsibility and indemnify and defend SANYO ELECTRIC CO., LTD., its affiliates, subsidiaries and distributors and all their officers and employees, jointly and severally, against any and all claims and litigation and all damages, cost and expenses associated with such use:
  - ② Not impose any responsibility for any fault or negligence which may be cited in any such claim or litigation on SANYO ELECTRIC CO., LTD., its affiliates, subsidiaries and distributors or any of their officers and employees jointly or severally.
- Information (including circuit diagrams and circuit parameters) herein is for example only; it is not guaranteed for volume production. SANYO believes information herein is accurate and reliable, but no guarantees are made or implied regarding its use or any infringements of intellectual property rights or other rights of third parties.

This catalog provides information as of July, 1998. Specifications and information herein are subject to change without notice.