

HIGH CURRENT FAST SWITCHING APPLICATION

DESCRIPTION

The 2N5336, 2N5337, 2N5338 and 2N5339 are silicon epitaxial planar NPN transistors in Jedec TO-39 metal case.

They are intended for high current switching applications up to 5A.

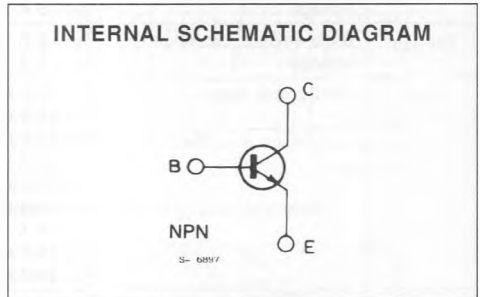
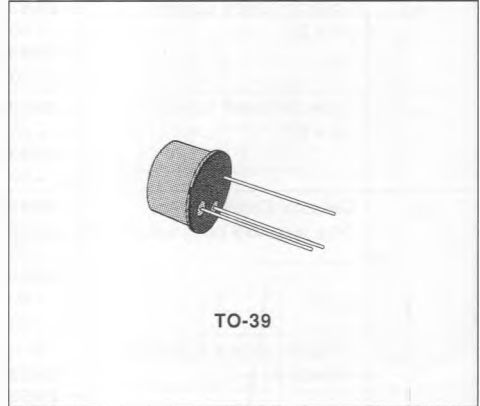

ABSOLUTE MAXIMUM RATINGS

Symbol	Parameter	2N5336 2N5337	2N5338 2N5339	Unit
V_{CBO}	Collector-base Voltage ($I_E = 0$)	80	100	V
V_{CEO}	Collector-emitter Voltage ($I_B = 0$)	80	100	V
V_{EBO}	Emitter-base Voltage ($I_C = 0$)		6	V
I_C	Collector Current		5	A
I_{CM}	Collector Peak Current		7	A
I_B	Base Current		1	A
P_{Tot}	Total Power Dissipation at $T_{amb} \leq 25^\circ\text{C}$ $T_{case} \leq 25^\circ\text{C}$		1	W
			6	W
T_{stg}	Storage Temperature		- 65 to 200	$^\circ\text{C}$
T_J	Junction Temperature		200	$^\circ\text{C}$

THERMAL DATA

$R_{th\ j-case}$	Thermal Resistance Junction-case	Max	29.2	$^{\circ}C/W$
$R_{th\ j-amb}$	Thermal Resistance Junction-ambient	Max	175	$^{\circ}C/W$

ELECTRICAL CHARACTERISTICS ($T_{case} = 25^{\circ}C$ unless otherwise specified)

Symbol	Parameter	Test Conditions	Min.	Typ.	Max.	Unit
I_{CBO}	Collector Cutoff Current ($I_E = 0$)	for 2N5336 and 2N5337 $V_{CB} = 80\ V$			10	μA
		for 2N5338 and 2N5339 $V_{CB} = 100\ V$			10	μA
I_{CEO}	Collector Cutoff Current ($I_B = 0$)	for 2N5336 and 2N5337 $V_{CE} = 75\ V$			100	μA
		for 2N5338 and 2N5339 $V_{CE} = 90\ V$			100	μA
I_{CEX}	Collector Cutoff Current ($V_{BE} = -1.5\ V$)	for 2N5336 and 2N5337 $V_{CE} = 75\ V$ $V_{CE} = 75\ V$ $T_{case} = 150^{\circ}C$			10 1	μA mA
		for 2N5338 and 2N5339 $V_{CE} = 90\ V$ $V_{CE} = 90\ V$ $T_{case} = 150^{\circ}C$			10 1	μA mA
$V_{CEO(sus)}^*$	Collector-emitter Sustaining Voltage ($I_B = 0$)	$I_C = 50\ mA$ for 2N5336 and 2N5337 for 2N5338 and 2N5339	80 100			V V
$V_{CE(sat)}^*$	Collector-emitter Saturation Voltage	$I_C = 2\ A$ $I_B = 0.2\ A$			0.7	V
		$I_C = 5\ A$ $I_B = 0.5\ A$			1.2	V
$V_{BE(sat)}^*$	Base-emitter Saturation Voltage	$I_C = 2\ A$ $I_B = 0.2\ A$			1.2	V
		$I_C = 5\ A$ $I_B = 0.5\ A$			1.8	V
h_{FE}^*	DC Current Gain	$I_C = 0.5\ A$ $V_{CE} = 2\ V$ for 2N5336 and 2N5337	30 60			
		for 2N5338 and 2N5339				
		$I_C = 2\ A$ $V_{CE} = 2\ V$ for 2N5336 and 2N5337	30 60		120 240	
		for 2N5338 and 2N5339				
		$I_C = 5\ A$ $V_{CE} = 2\ V$ for 2N5336 and 2N5337	20 40			
		for 2N5338 and 2N5339				
f_T	Transition Frequency	$I_C = 0.5\ A$ $V_{CE} = 10\ V$	30			MHz
C_{CBO}	Collector-base Capacitance	$V_{CB} = 10\ V$ $I_E = 0$ $f = 0.1\ MHz$			250	pF
t_{on}	Turn-on Time	$I_C = 2\ A$ $V_{CC} = 40\ V$ $I_{B1} = 0.2\ A$			200	ns
t_s	Storage Time	$I_C = 2\ A$ $V_{CC} = 40\ V$ $I_{B1} = -I_{B2} = 0.2\ A$			2	μs
t_f	Fall Time				200	ns

* Pulsed : pulse duration = 300 μs , duty cycle = 1.5%.

Safe Operating Areas.

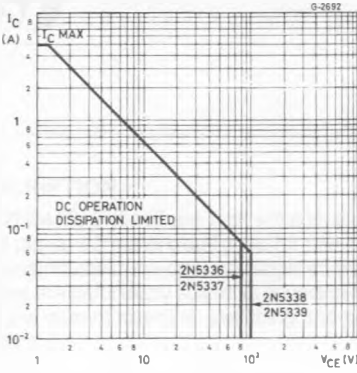

DC Current Gain.

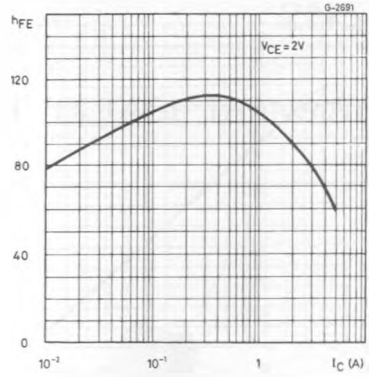

Collector-emitter Saturation Voltage.

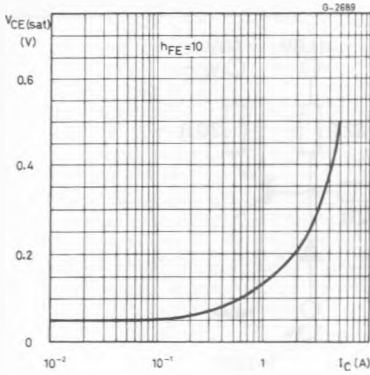

Base-emitter Saturation Voltage.

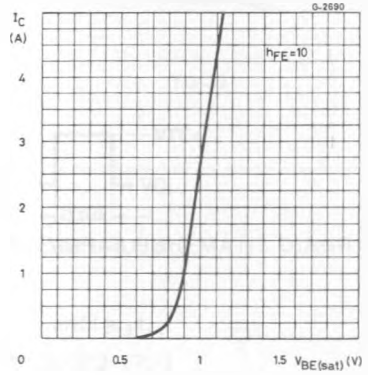

Collector-base Capacitance.

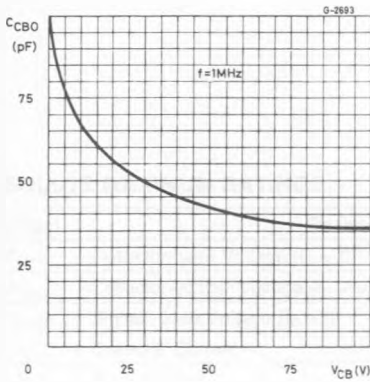

Saturated Switching Characteristics.

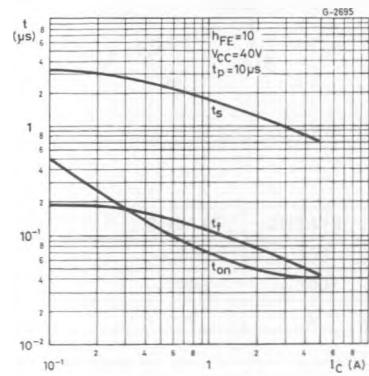

Power Rating Chart.

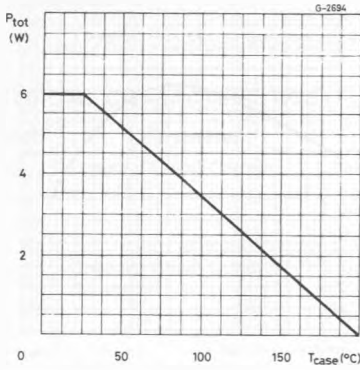

Switching Time Test Circuit.

