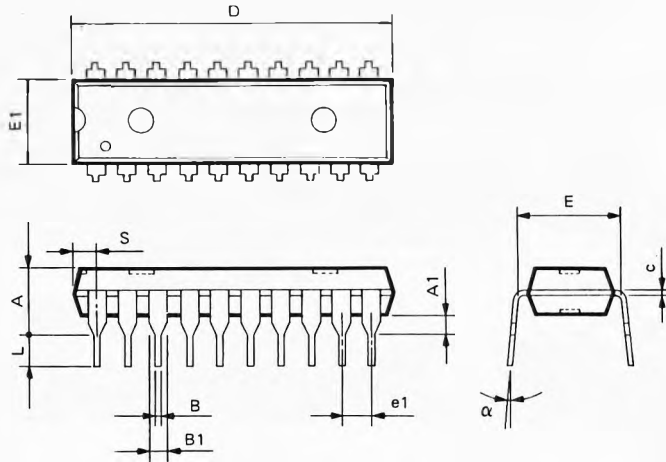

P-DIP 20L Outline Dimension

Symbol	Dimensions in inch	Dimensions in mm
A	0.175 Max.	4.445 Max.
A1	0.010 Min.	0.254 Min.
B	0.018 + 0.004 - 0.002	0.457 + 0.102 - 0.051
B1	0.060 + 0.004 - 0.002	1.524 + 0.102 - 0.051
c	0.010 + 0.004 - 0.002	0.254 + 0.102 - 0.051
D	1.026 (1.040 Max.)	26.060 (26.416 Max.)
E	0.300 ± 0.010	7.620 ± 0.254
E1	0.250 (0.275 Max.)	6.350 (6.985 Max.)
e1	0.100 ± 0.010	2.540 ± 0.254
L	0.130 ± 0.010	3.302 ± 0.254
α	0° ~ 15°	0° ~ 15°
S	0.075 Max.	1.905 Max.