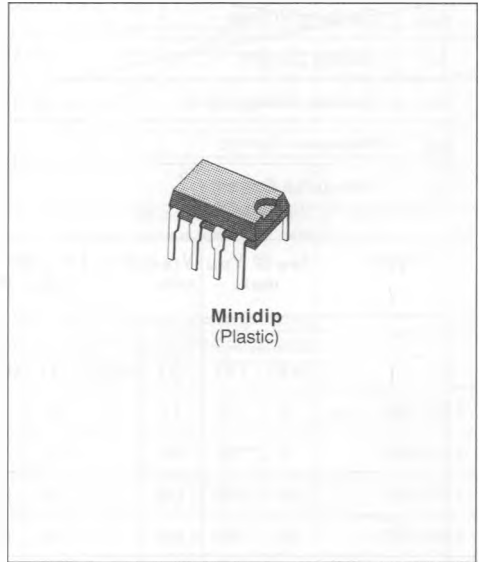

BIDIRECTIONAL TRISIL

- CHARACTERISTIC OF STAND-OFF AND BREAKDOWN VOLTAGE SIMILAR TO A TRANSIL (V_{off})
- HIGH FLOWOUT CAPABILITY BECAUSE OF ITS BREAKOVER CHARACTERISTICS (V_{on})
- AUTOMATIC RECOVERY AFTER SURGE

DESCRIPTION

The LS5018B, LS5060B and LS5120B/B1 are bidirectional transient overvoltage suppressor designed to protect sensitive components in electronic telephones and telecommunication equipments against transient caused by lightning, induction from power lines, etc.

ABSOLUTE RATINGS (limiting values) ($T_j = 25\text{ }^\circ\text{C}$)

Symbol	Parameter	Value	Unit
I_{pp}	Peak Pulse Current	1 ms expo	100
		8-20 μs expo*	500
I_{TSM}	Non Repetitive Surge Peak on-state Current	$t_p = 20\text{ ms} - \text{Sinus}$	50
di/dt	Critical Rate of Rise of on-state Current	Non repetitive	100
T_{stg}	Storage and Junction Temperature Range	- 40 to 150	$^\circ\text{C}$
T_j		150	$^\circ\text{C}$

THERMAL RESISTANCE

Symbol	Parameter	Value	Unit
$R_{th(j-a)}$	Junction to Ambient	80	$^\circ\text{C}/\text{W}$

* ANSI STD C62.

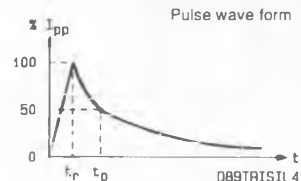

ELECTRICAL CHARACTERISTICS

(T_J = 25 °C)

Symbol	Parameter
V _{RM}	Stand-off Voltage
V _{BR}	Breakdown Voltage
V _{BO}	Clamping Voltage
I _H	Holding Current
V _T	On-state Voltage @ I _T
I _{BO}	Breakover Current
I _{pp}	Peak-pulse Current

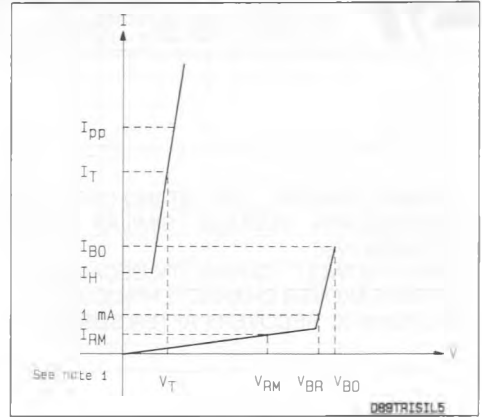

Type	I _{RM} @ V _{RM} max.		V _(BR) @ I _R min.		V _{BO} @ I _{BO} max. min. typ. max. See note 2			I _H min.	V _T typ. I _T = 1 A	C max. V _R = 5 V F = 1 MHz
	(μA)	(V)	(V)	(mA)	(V)	(mA)	(mA)	(mA)	(V)	(pF)
LS5018B	5	16	17	1	22		1300	200	2	150
LS5060B	10	50	60	1	85		1000	200	2	150
LS5120B	20	100	120	1	180	500	1250	250	2	150
LS5120B1	20	100	120	1	180	500	1250	200	2	150

Notes : 1. Same characteristic both sides.
 2. These devices are not designed to function as zeners ; continuous operation between 1 mA and I_{BO} will damage them.

PACKAGE MECHANICAL DATA

MINIDIP Plastic

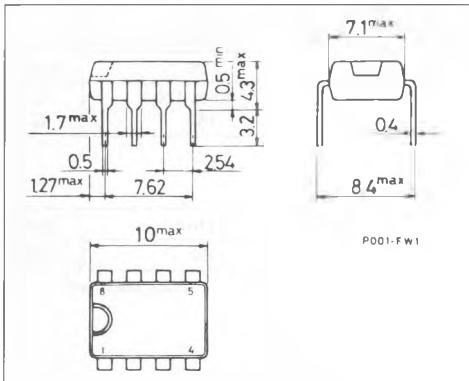

CONNECTION DIAGRAM

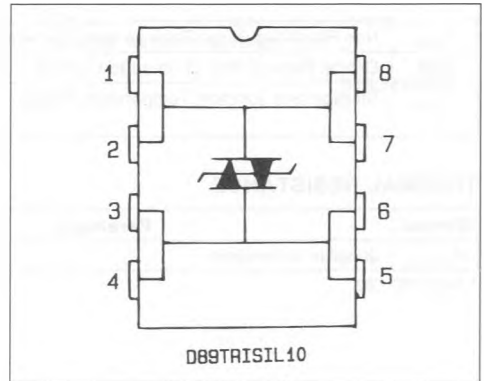

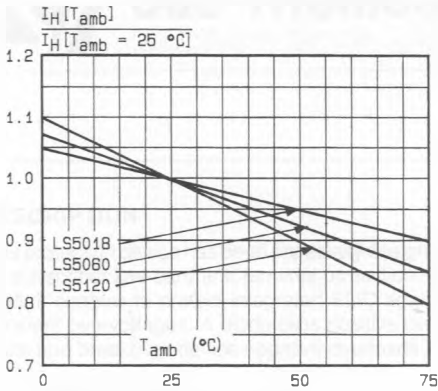

Fig.1 - Relative variation of holding current versus ambient temperature.

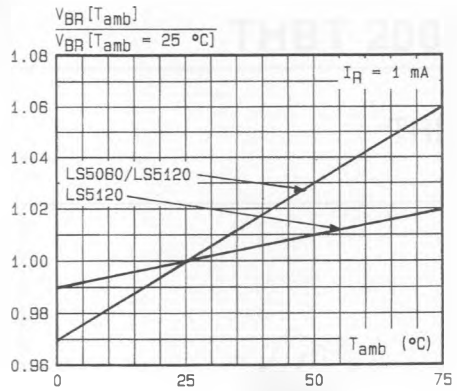

Fig.2 - Relative variation of breakdown voltage versus ambient temperature.

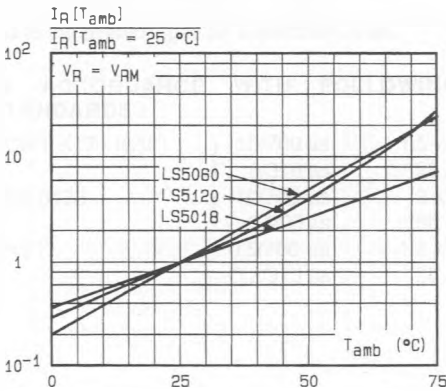

Fig.3 - Relative variation of leakage current versus ambient temperature.

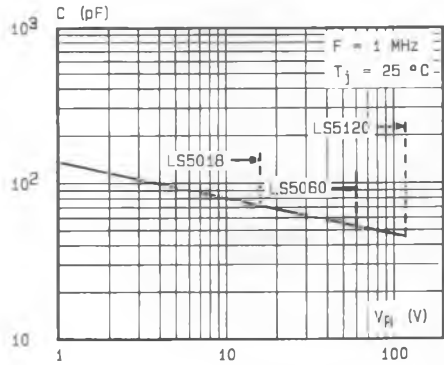

Fig.4 - Junction capacitance versus reverse applied voltage.

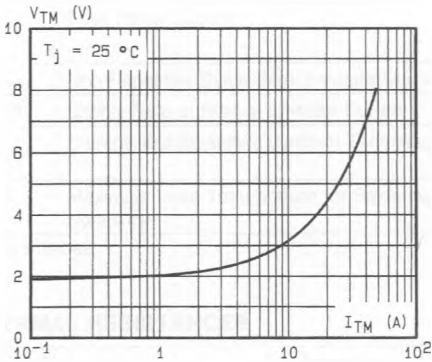

Fig.5 - On-state voltage versus on-state current (typical values).

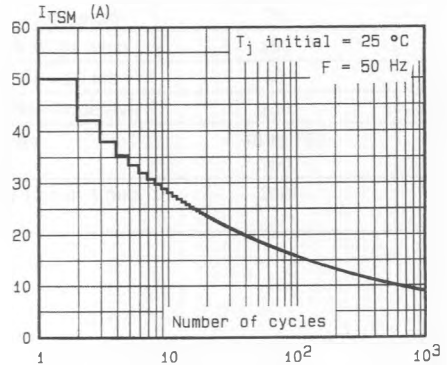

Fig.6 - Non repetitive surge peak on-state current versus number of cycles.