

Features

- Glass Passivated Die Construction
- Fast Switching
- High Current Capability
- Low Reverse Leakage Current
- High Surge Current Capability
- Plastic Material has UL Flammability Classification 94V-O

Mechanical Data

- Case: Molded Plastic
- Terminals: Plated Leads Solderable per MIL-STD-202, Method 208
- Polarity: See Diagram
- Weight: 2.24 grams (approx.)
- Mounting Position: Any
- Marking: Type Number

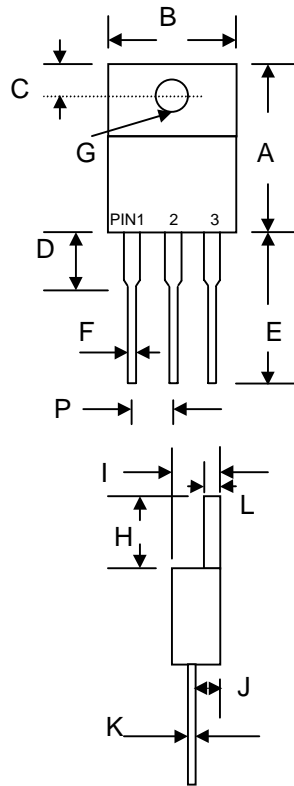

| TO-220 | | |
|----------------------|--------|--------|
| Dim | Min | Max |
| A | 14.9 | 15.1 |
| B | — | 10.5 |
| C | 2.62 | 2.87 |
| D | 3.56 | 4.06 |
| E | 13.46 | 14.22 |
| F | 0.68 | 0.94 |
| G | 3.74 Ø | 3.91 Ø |
| H | 5.84 | 6.86 |
| I | 4.44 | 4.70 |
| J | 2.54 | 2.79 |
| K | 0.35 | 0.64 |
| L | 1.14 | 1.40 |
| P | 2.41 | 2.67 |
| All Dimensions in mm | | |

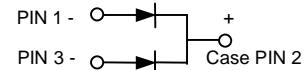

Maximum Ratings and Electrical Characteristics @ $T_A=25^\circ\text{C}$ unless otherwise specified

Single Phase, half wave, 60Hz, resistive or inductive load.
For capacitive load, derate current by 20%.

| Characteristic | Symbol | FR 1601G | FR 1602G | FR 1603G | FR 1604G | FR 1605G | FR 1606G | FR 1607G | Unit |
|---|----------------|-------------|----------|----------|----------|----------|----------|----------|------------------|
| Peak Repetitive Reverse Voltage | V_{RRM} | 50 | 100 | 200 | 400 | 600 | 800 | 1000 | V |
| Working Peak Reverse Voltage | V_{RWM} | | | | | | | | |
| DC Blocking Voltage | V_R | | | | | | | | |
| RMS Reverse Voltage | $V_{R(RMS)}$ | 35 | 70 | 140 | 280 | 420 | 560 | 700 | V |
| Average Rectified Output Current @ $T_C = 105^\circ\text{C}$ | I_O | 16 | | | | | | | A |
| Non-Repetitive Peak Forward Surge Current 8.3ms Single half sine-wave superimposed on rated load (JEDEC Method) | I_{FSM} | 150 | | | | | | | A |
| Forward Voltage @ $I_F = 8.0\text{A}$ | V_{FM} | 1.3 | | | | | | | V |
| Peak Reverse Current @ $T_A = 25^\circ\text{C}$ At Rated DC Blocking Voltage @ $T_A = 125^\circ\text{C}$ | I_{RM} | 5.0 100 | | | | | | | μA |
| Reverse Recovery Time (Note 1) | t_{rr} | 150 | | | 250 | 500 | | nS | |
| Operating and Storage Temperature Range | T_J, T_{STG} | -65 to +150 | | | | | | | $^\circ\text{C}$ |

Note: 1. Measured with $I_F = 0.5\text{A}$, $I_R = 1.0\text{A}$, $IRR = 0.25\text{A}$. See figure 5.

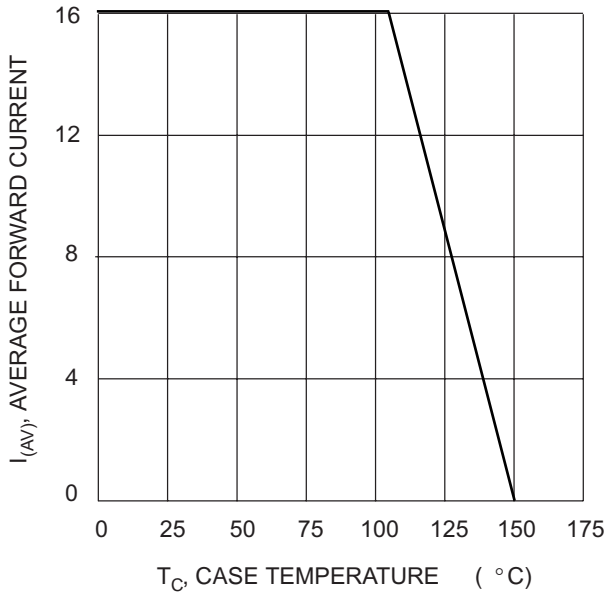

Fig. 1, Typical Forward Current Derating Curve

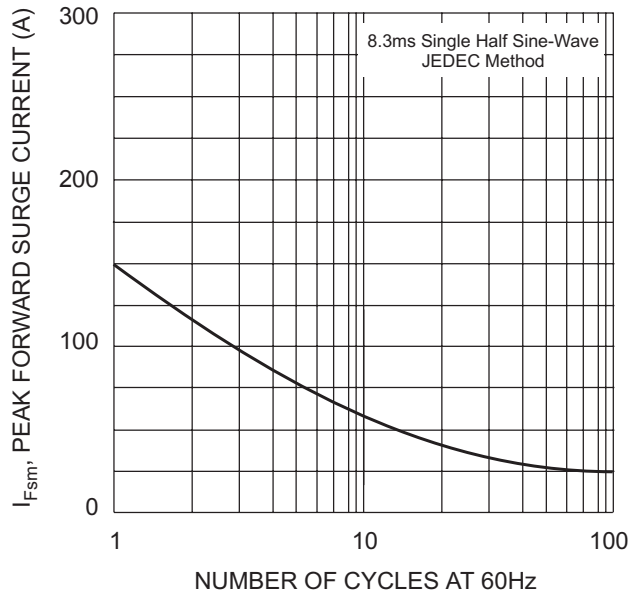

Fig. 2 Max Non-Repetitive Peak Surge Current

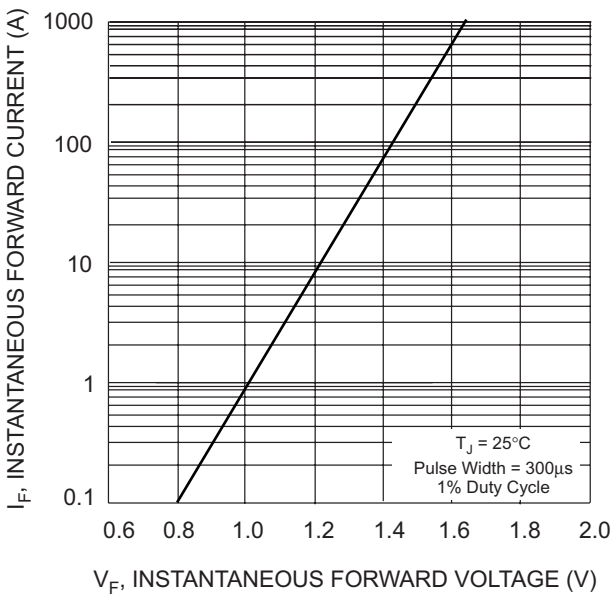

Fig. 3, Typical Instantaneous Forward Characteristics

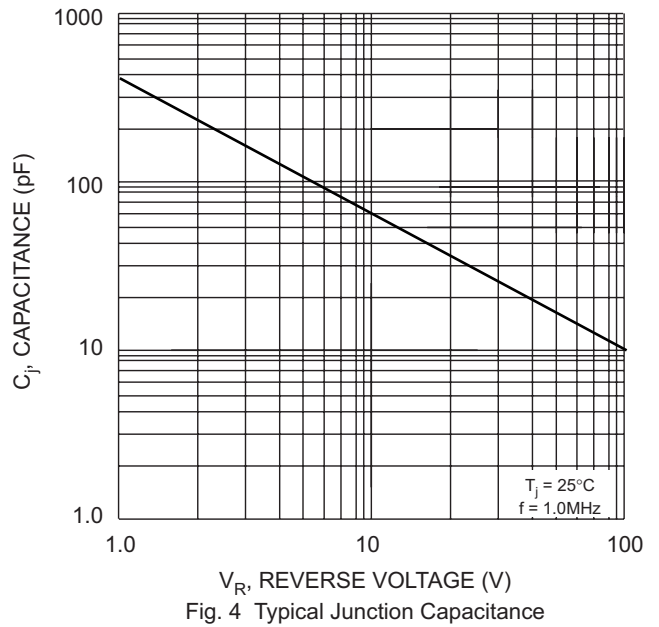
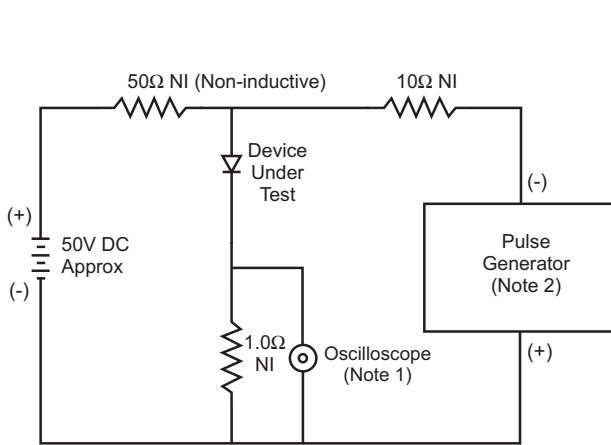

Fig. 4 Typical Junction Capacitance



- Notes:
1. Rise Time = 7.0ns max. Input Impedance = 1.0MΩ, 22pF.
 2. Rise Time = 10ns max. Input Impedance = 50Ω.

Fig. 5 Reverse Recovery Time Characteristic and Test Circuit