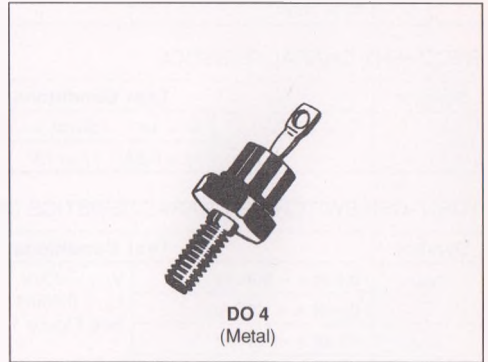

## FAST RECOVERY RECTIFIER DIODES

- VERY LOW REVERSE RECOVERY TIME
- VERY LOW SWITCHING LOSSES
- LOW NOISE TURN-OFF SWITCHING

**SUITABLE APPLICATIONS :**

- FREE WHEELING DIODE IN CONVERTERS AND MOTOR CONTROL CIRCUITS
- RECTIFIER IN S.M.P.S.

**ABSOLUTE RATINGS** (limiting values)

Symbol	Parameter	Value	Unit	
$I_{FRM}$	Repetitive Peak Forward Current	$t_p \leq 10\mu s$	200	A
$I_{F(RMS)}$	RMS Forward Current		25	A
$I_{F(AV)}$	Average Forward Current	$T_{case} = 100^\circ C$ $\delta = 0.5$	12	A
$I_{FSM}$	Surge non Repetitive Forward Current	$t_p = 10ms$ sinusoidal	200	A
P	Power Dissipation	$T_{case} = 100^\circ C$	20	W
$T_{stg}$ $T_j$	Storage and Junction Temperature Range		- 40 to + 150	$^\circ C$

Symbol	Parameter	BYT 12-			Unit
		200	300	400	
$V_{RRM}$	Repetitive Peak Reverse Voltage	200	300	400	V
$V_{RSM}$	Non Repetitive Peak Reverse Voltage	220	330	440	V

**THERMAL RESISTANCE**

Symbol	Test Conditions	Value	Unit
$R_{th(j-c)}$	Junction-case	2.5	$^\circ C/W$

**ELECTRICAL CHARACTERISTICS**

**STATIC CHARACTERISTICS**

Symbol	Test Conditions		Min.	Typ.	Max.	Unit
$I_R$	$T_j = 25^\circ\text{C}$	$V_R = V_{RRM}$			15	$\mu\text{A}$
	$T_j = 100^\circ\text{C}$				2.5	$\text{mA}$
$V_F$	$T_j = 25^\circ\text{C}$	$I_F = 12\text{A}$			1.5	V
	$T_j = 100^\circ\text{C}$				1.4	

**RECOVERY CHARACTERISTICS**

Symbol	Test Conditions		Min.	Typ.	Max.	Unit
$t_{rr}$	$T_j = 25^\circ\text{C}$	$I_F = 1\text{A}$ $di_F/dt = -15\text{A}/\mu\text{s}$ $V_R = 30\text{V}$			100	ns
		$I_F = 0.5\text{A}$ $I_R = 1\text{A}$ $I_{rr} = 0.25\text{A}$			50	

**TURN - OFF SWITCHING CHARACTERISTICS (Without Series Inductance)**

Symbol	Test Conditions		Min.	Typ.	Max.	Unit
$t_{IRM}$	$di_F/dt = -50\text{A}/\mu\text{s}$	$V_{CC} = 200\text{V}$ $I_F = 12\text{A}$ $L_p \leq 0.05\mu\text{H}$ $T_j = 100^\circ\text{C}$ See Figure 11			75	ns
	$di_F/dt = -100\text{A}/\mu\text{s}$				50	
$I_{RM}$	$di_F/dt = -50\text{A}/\mu\text{s}$				3.8	A
	$di_F/dt = -100\text{A}/\mu\text{s}$				4.3	

**TURN - OFF OVERVOLTAGE COEFFICIENT (With Series Inductance)**

Symbol	Test Conditions		Min.	Typ.	Max.	Unit
$C = \frac{V_{RP}}{V_{CC}}$	$T_j = 100^\circ\text{C}$ $di_F/dt = -12\text{A}/\mu\text{s}$	$V_{CC} = 120\text{V}$ $I_F = I_{F(AV)}$ See note $L_p = 7\mu\text{H}$ See Figure 12		3.3		

Note : Applicable to BYT12-400 only

To evaluate the conduction losses use the following equations :

$$V_F = 1.1 + 0.022 I_F \qquad P = 1.1 \times I_{F(AV)} + 0.022 I_F^2_{(RMS)}$$

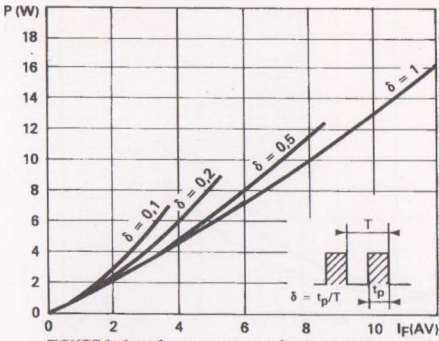

FIGURE 1 : Low frequency power losses versus average current.

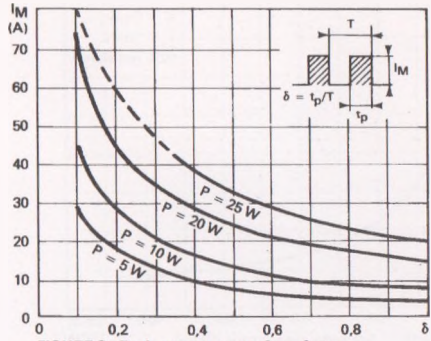

FIGURE 2 : Peak current versus form factor.

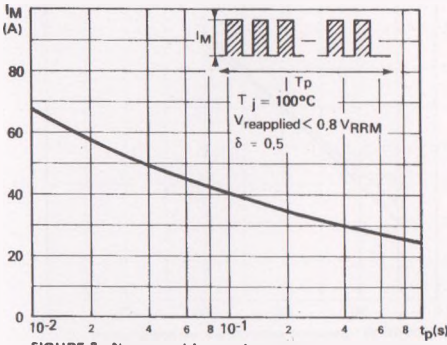

FIGURE 3 : Non repetitive peak surge current versus overload duration.

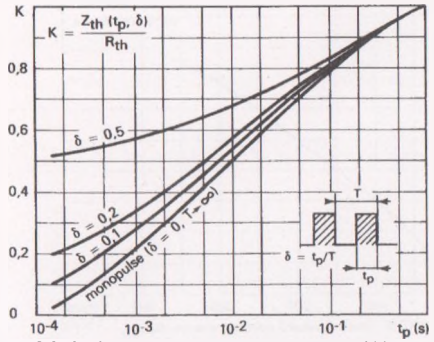

FIGURE 4 : Thermal impedance versus pulse width.

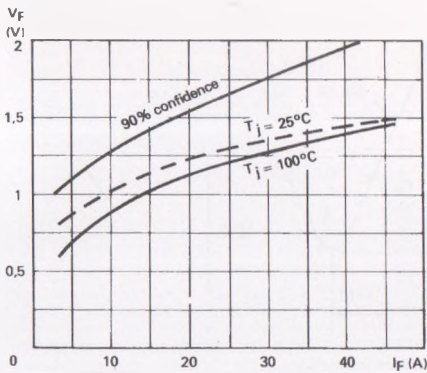

FIGURE 5 : Voltage drop versus forward current.

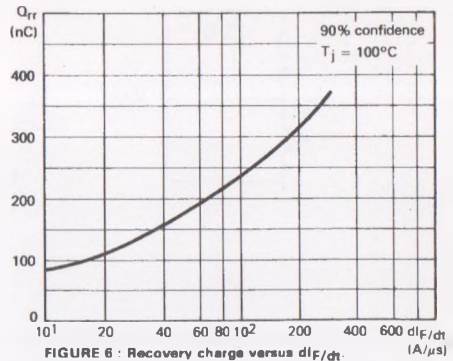

FIGURE 6 : Recovery charge versus  $dI_F/dt$ .

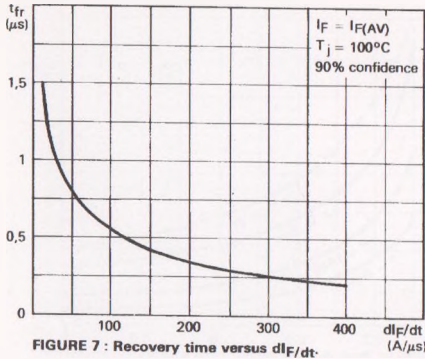

FIGURE 7 : Recovery time versus  $dI_F/dt$ .

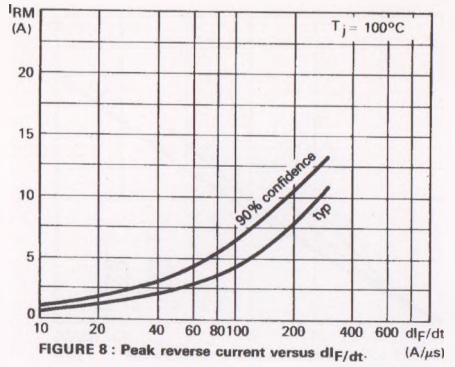

FIGURE 8 : Peak reverse current versus  $dI_F/dt$ .

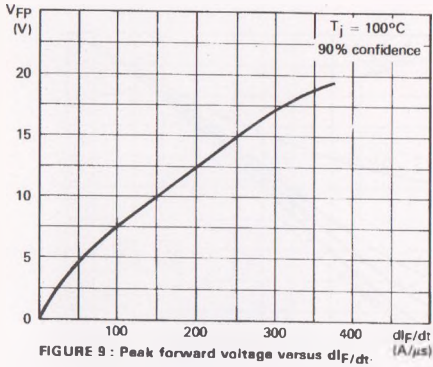

FIGURE 9 : Peak forward voltage versus  $dI_F/dt$ .

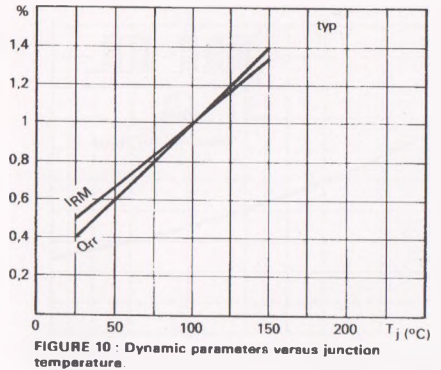

FIGURE 10 : Dynamic parameters versus junction temperature.

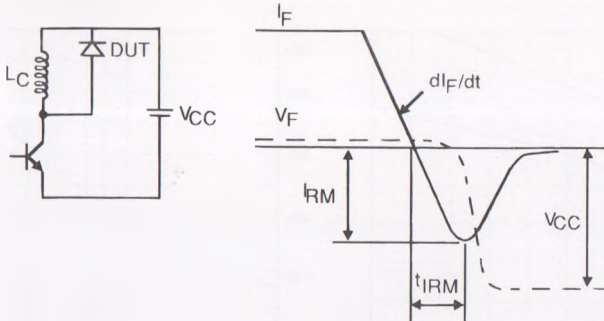

Figure 11 : Turn-off switching characteristics (without series inductance).

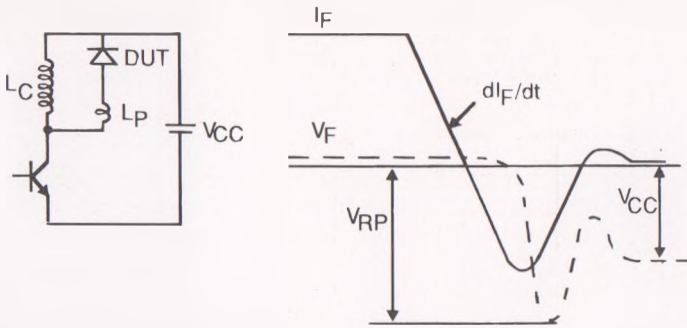

Figure 12 : Turn-off switching characteristics (with series inductance).