

## BACKUP-BATTERY SUPERVISORS FOR RAM RETENTION

### FEATURES

- Supply Current of 40  $\mu$ A (Max)
- Battery-Supply Current of 100 nA (Max)
- Precision Supply Voltage Monitor 3.3 V, 5 V, Other Options on Request
- Backup-Battery Voltage Can Exceed  $V_{DD}$
- Power On Reset Generator With Fixed 100-ms Reset Delay Time
- Voltage Monitor For Power-Fail or Low-Battery Monitoring
- Battery Freshness Seal (TPS3619)
- Pin-For-Pin Compatible With MAX819, MAX703, and MAX704
- 8-Pin MSOP Package
- Temperature Range  $-40^{\circ}\text{C}$  to  $+85^{\circ}\text{C}$

### APPLICATIONS

- Fax Machines
- Set-Top Boxes
- Advanced Voice Mail Systems
- Portable Battery-Powered Equipment
- Computer Equipment
- Advanced Modems
- Automotive Systems
- Portable Long-Time Monitoring Equipment
- Point-of-Sale Equipment

### DESCRIPTION

The TPS3619 and TPS3620 families of supervisory circuits monitor and control processor activity by providing backup-battery switchover for data retention of CMOS RAM.

During power on,  $\overline{\text{RESET}}$  is asserted when the supply voltage ( $V_{DD}$  or  $V_{BAT}$ ) becomes higher than 1.1 V. Thereafter, the supply voltage supervisor monitors  $V_{DD}$  and keeps  $\overline{\text{RESET}}$  output active as long as  $V_{DD}$  remains below the threshold voltage ( $V_{IT}$ ). An internal timer delays the return of the output to the inactive state (high) to ensure proper system reset. The delay time starts after  $V_{DD}$  has risen above  $V_{IT}$ . When the supply voltage drops below  $V_{IT}$ , the output becomes active (low) again.

The product spectrum is designed for supply voltages of 3.3 V and 5 V. The TPS3619 and TPS3620 are available in an 8-pin MSOP package and are characterized for operation over a temperature range of  $-40^{\circ}\text{C}$  to  $+85^{\circ}\text{C}$ .

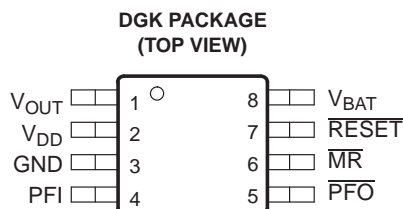

  
ACTUAL SIZE  
3,05 mm x 4,98 mm

### TYPICAL OPERATING CIRCUIT

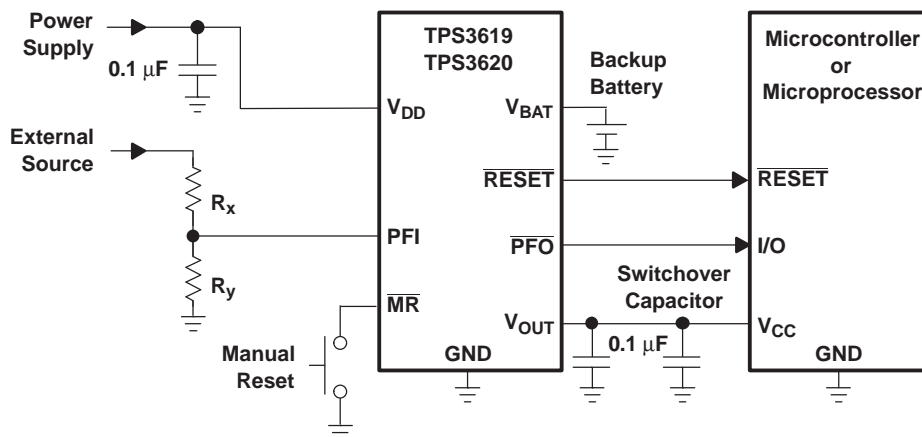

Please be aware that an important notice concerning availability, standard warranty, and use in critical applications of Texas Instruments semiconductor products and disclaimers thereto appears at the end of this data sheet.

All trademarks are the property of their respective owners.



This integrated circuit can be damaged by ESD. Texas Instruments recommends that all integrated circuits be handled with appropriate precautions. Failure to observe proper handling and installation procedures can cause damage.

ESD damage can range from subtle performance degradation to complete device failure. Precision integrated circuits may be more susceptible to damage because very small parametric changes could cause the device not to meet its published specifications.

### PACKAGE INFORMATION<sup>(1)</sup>

PRODUCT	SPECIFIED TEMPERATURE RANGE	PACKAGE MARKING	ORDERING NUMBER	TRANSPORT MEDIA, QUANTITY
TPS3619-33	-40°C to +85°C	AFL	TPS3619-33DGK	Tube, 80
			TPS3619-33DGKR	Tape and Reel, 2500
AFM		TPS3619-50DGK	Tube, 80	
		TPS3619-50DGKR	Tape and Reel, 2500	
TPS3620-33		ANL	TPS3620-33DGKT	Tape and Reel, 250
			TPS3620-33DGKR	Tape and Reel, 2500
TPS3620-50	ANM	TPS3620-50DGKT	Tape and Reel, 250	
		TPS3620-50DGKR	Tape and Reel, 2500	

(1) For the most current specifications and package information, see the Package Option Addendum located at the end of this data sheet or refer to our web site at [www.ti.com](http://www.ti.com).

### STANDARD AND APPLICATION SPECIFIC VERSIONS

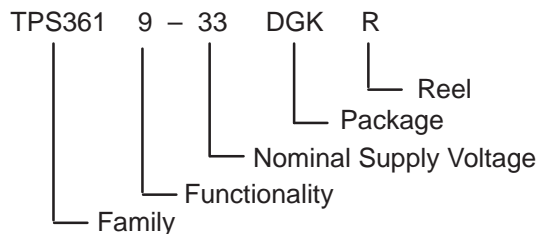

DEVICE NAME	NOMINAL VOLTAGE <sup>(1)</sup> , V <sub>NOM</sub>
TPS3619-33 DGK	3.3 V
TPS3619-50 DGK	5.0 V
TPS3620-33 DGK	3.3 V
TPS3620-50 DGK	5.0 V

(1) For other threshold voltage versions, contact the local TI sales office for availability and lead-time.

### ABSOLUTE MAXIMUM RATINGS

Over operating free-air temperature (unless otherwise noted).<sup>(1)</sup>

		UNIT
Supply voltage:	V <sub>DD</sub> <sup>(2)</sup>	7 V
	$\overline{MR}$ and PFI pins <sup>(2)</sup>	-0.3 V to (V <sub>DD</sub> + 0.3 V)
Continuous output current:	V <sub>OUT</sub> , I <sub>O</sub>	400 mA
	All other pins, I <sub>O</sub> <sup>(2)</sup>	±10 mA
Continuous total power dissipation		See Dissipation Rating Table
Operating free-air temperature range, T <sub>A</sub>		-40°C to +85°C
Storage temperature range, T <sub>stg</sub>		-65°C to +150°C
Lead temperature soldering 1,6 mm (1/16 inch) from case for 10 seconds		+260°C

(1) Stresses beyond those listed under *absolute maximum ratings* may cause permanent damage to the device. These are stress ratings only, and functional operation of the device at these or any other conditions beyond those indicated under recommended operating conditions is not implied. Exposure to absolute-maximum-rated conditions for extended periods may affect device reliability.

(2) All voltage values are with respect to GND. For reliable operation, the device must not be operated at 7 V for more than t = 1000h continuously.

### DISSIPATION RATING TABLE

PACKAGE	θ <sub>JC</sub>	θ <sub>JA</sub> (LOW-K)	θ <sub>JA</sub> (HIGH-K)	T <sub>A</sub> < 25°C POWER RATING	DERATING FACTOR ABOVE T <sub>A</sub> = +25°C	T <sub>A</sub> = +70°C POWER RATING	T <sub>A</sub> = +85°C POWER RATING
DGK	55°C/W	266°C/W	180°C/W	470 mW	3.76 mW/°C	301 mW	241 mW

## RECOMMENDED OPERATING CONDITIONS

At specified temperature range.

	MIN	MAX	UNIT
Supply voltage, $V_{DD}$	1.65	5.5	V
Battery supply voltage, $V_{BAT}$	1.5	5.5	V
Input voltage, $V_I$	0	$V_{DD} + 0.3$	V
High-level input voltage, $V_{IH}$	$0.7 \times V_{DD}$		V
Low-level input voltage, $V_{IL}$		$0.3 \times V_{DD}$	V
Continuous output current at $V_{OUT}$ , $I_O$		300	mA
Input transition rise and fall rate at $\overline{MR}$		100	ns/V
Slew rate at $V_{DD}$ or $V_{BAT}$ , $\Delta t/\Delta V$		1	V/ $\mu$ s
Operating free-air temperature range, $T_A$	-40	+85	$^{\circ}$ C

## ELECTRICAL CHARACTERISTICS

Over recommended operating conditions (unless otherwise noted).

PARAMETER			TEST CONDITIONS	MIN	TYP	MAX	UNIT
$V_{OH}$	High-level output voltage	$\overline{RESET}$	$V_{DD} = 1.8\text{ V}$ , $I_{OH} = -400\ \mu\text{A}$	$V_{DD} - 0.2\text{ V}$			V
			$V_{DD} = 3.3\text{ V}$ , $I_{OH} = -2\text{ mA}$	$V_{DD} - 0.4\text{ V}$			
			$V_{DD} = 5\text{ V}$ , $I_{OH} = -3\text{ mA}$	$V_{DD} - 0.4\text{ V}$			
		$\overline{PFO}$	$V_{DD} = 1.8\text{ V}$ , $I_{OH} = -20\ \mu\text{A}$	$V_{DD} - 0.3\text{ V}$			V
			$V_{DD} = 3.3\text{ V}$ , $I_{OH} = -80\ \mu\text{A}$	$V_{DD} - 0.4\text{ V}$			
			$V_{DD} = 5\text{ V}$ , $I_{OH} = -120\ \mu\text{A}$	$V_{DD} - 0.4\text{ V}$			
$V_{OL}$	Low-level output voltage	$\overline{RESET}$ $\overline{PFO}$	$V_{DD} = 1.8\text{ V}$ , $I_{OL} = -400\ \mu\text{A}$			0.2	V
			$V_{DD} = 3.3\text{ V}$ , $I_{OL} = 2\text{ mA}$			0.4	
			$V_{DD} = 5\text{ V}$ , $I_{OL} = 3\text{ mA}$			0.4	
$V_{res}$	Power-up reset voltage (see <sup>(1)</sup> )		$I_{OL} = 20\ \mu\text{A}$ , $V_{BAT} > 1.1\text{ V}$ or $V_{DD} > 1.1\text{ V}$			0.4	V
$V_{OUT}$	Normal mode		$I_{OUT} = 8.5\text{ mA}$ , $V_{BAT} = 0\text{ V}$	$V_{DD} = 1.8\text{ V}$	$V_{DD} - 50\text{ mV}$		V
			$I_{OUT} = 125\text{ mA}$ , $V_{BAT} = 0\text{ V}$	$V_{DD} = 3.3\text{ V}$	$V_{DD} - 150\text{ mV}$		
			$I_{OUT} = 200\text{ mA}$ , $V_{BAT} = 0\text{ V}$	$V_{DD} = 5\text{ V}$	$V_{DD} - 200\text{ mV}$		
	Battery-backup mode		$I_{OUT} = 0.5\text{ mA}$ , $V_{BAT} = 1.5\text{ V}$	$V_{DD} = 0\text{ V}$	$V_{BAT} - 20\text{ mV}$		V
			$I_{OUT} = 7.5\text{ mA}$ , $V_{BAT} = 3.3\text{ V}$		$V_{BAT} - 113\text{ mV}$		
$r_{DS(on)}$	$V_{DD}$ to $V_{OUT}$ on-resistance		$V_{DD} = 5\text{ V}$		0.6	1	$\Omega$
	$V_{BAT}$ to $V_{OUT}$ on-resistance		$V_{DD} = 3.3\text{ V}$		8	15	
$V_{IT-}$	Negative-going input threshold voltage (see <sup>(2)</sup> )	TPS3619-33	$T_A = -40^{\circ}\text{C}$ to $85^{\circ}\text{C}$	2.88	2.93	3	V
$V_{PFI}$		TPS3619-50		4.46	4.55	4.64	
		PFI		1.13	1.15	1.17	
$V_{hys}$	Hysteresis	$V_{IT}$	$1.65\text{ V} < V_{IT} < 2.5\text{ V}$		20		mV
			$2.5\text{ V} < V_{IT} < 3.5\text{ V}$		40		
			$3.5\text{ V} < V_{IT} < 5.5\text{ V}$		60		
		PFI		12			
		VBSW (see <sup>(3)</sup> )	$V_{DD} = 1.8\text{ V}$		55		

(1) The lowest supply voltage at which RESET becomes active.  $t_{r,VDD} \geq 15\ \mu\text{s/V}$ .

(2) To ensure the best stability of the threshold voltage, a bypass capacitor (ceramic, 0.1  $\mu\text{F}$ ) should be placed near the supply terminals.

(3) For  $V_{DD} < 1.6\text{ V}$ ,  $V_{OUT}$  switches to  $V_{BAT}$  regardless of  $V_{BAT}$ .

## ELECTRICAL CHARACTERISTICS (continued)

Over recommended operating conditions (unless otherwise noted).

PARAMETER			TEST CONDITIONS		MIN	TYP	MAX	UNIT
$I_{IH}$	High-level input current	$\overline{MR}$	$\overline{MR} = 0.7 \times V_{DD}$	$V_{DD} = 5\text{ V}$	-33		-76	$\mu\text{A}$
$I_{IL}$	Low-level input current		$\overline{MR} = 0\text{ V}$		-110	-255		
$I_i$	Input current	PFI			-25		25	nA
$I_{OS}$	Short-circuit current	$\overline{PFO}$	$\overline{PFO} = 0\text{ V}$	$V_{DD} = 1.8\text{ V}$			-0.3	mA
				$V_{DD} = 3.3\text{ V}$			-1.1	
				$V_{DD} = 5\text{ V}$			-2.4	
$I_{DD}$	$V_{DD}$ supply current		$V_{OUT} = V_{DD}$				40	$\mu\text{A}$
			$V_{OUT} = V_{BAT}$				40	
$I_{(BAT)}$	$V_{BAT}$ supply current		$V_{OUT} = V_{DD}$		-0.1		0.1	$\mu\text{A}$
			$V_{OUT} = V_{BAT}$				0.5	
$C_i$	Input capacitance		$V_i = 0\text{ V to }5\text{ V}$			5		pF

## TIMING REQUIREMENTS

At  $R_L = 1\text{ M}\Omega$ ,  $C_L = 50\text{ pF}$ ,  $T_A = -40^\circ\text{C to }+85^\circ\text{C}$ .

PARAMETER			TEST CONDITIONS		MIN	TYP	MAX	UNIT
$t_w$	Pulse width	at $V_{DD}$	$V_{IH} = V_{IT} + 0.2\text{ V}$ , $V_{IL} = V_{IT} - 0.2\text{ V}$		6			$\mu\text{s}$
		at $\overline{MR}$	$V_{DD} = V_{IT} + 0.2\text{ V}$ , $V_{IL} = 0.3 \times V_{DD}$ , $V_{IH} = 0.7 \times V_{DD}$		100			ns

## SWITCHING CHARACTERISTICS

At  $R_L = 1\text{ M}\Omega$ ,  $C_L = 50\text{ pF}$ ,  $T_A = -40^\circ\text{C to }+85^\circ\text{C}$ .

PARAMETER			TEST CONDITIONS		MIN	TYP	MAX	UNIT
$t_d$	Delay time		$V_{DD} \geq V_{IT} + 0.2\text{ V}$ , $\overline{MR} \geq 0.7 \times V_{DD}$ See <a href="#">timing diagram</a>		60	100	140	ms
$t_{PHL}$	Propagation (delay) time, high-to-low level output	$V_{DD}$ to RESET	$V_{IL} = V_{IT} - 0.2\text{ V}$ , $V_{IH} = V_{IT} + 0.2\text{ V}$			2	5	$\mu\text{s}$
		PFI to $\overline{PFO}$ delay	$V_{IL} = V_{PFI} - 0.2\text{ V}$ , $V_{IH} = V_{PFI} + 0.2\text{ V}$			3	5	
		$\overline{MR}$ to RESET	$V_{DD} \geq V_{IT} + 0.2\text{ V}$ , $V_{IL} = 0.3 \times V_{DD}$ , $V_{IH} = 0.7 \times V_{DD}$			0.1	1	

**TIMING DIAGRAM**

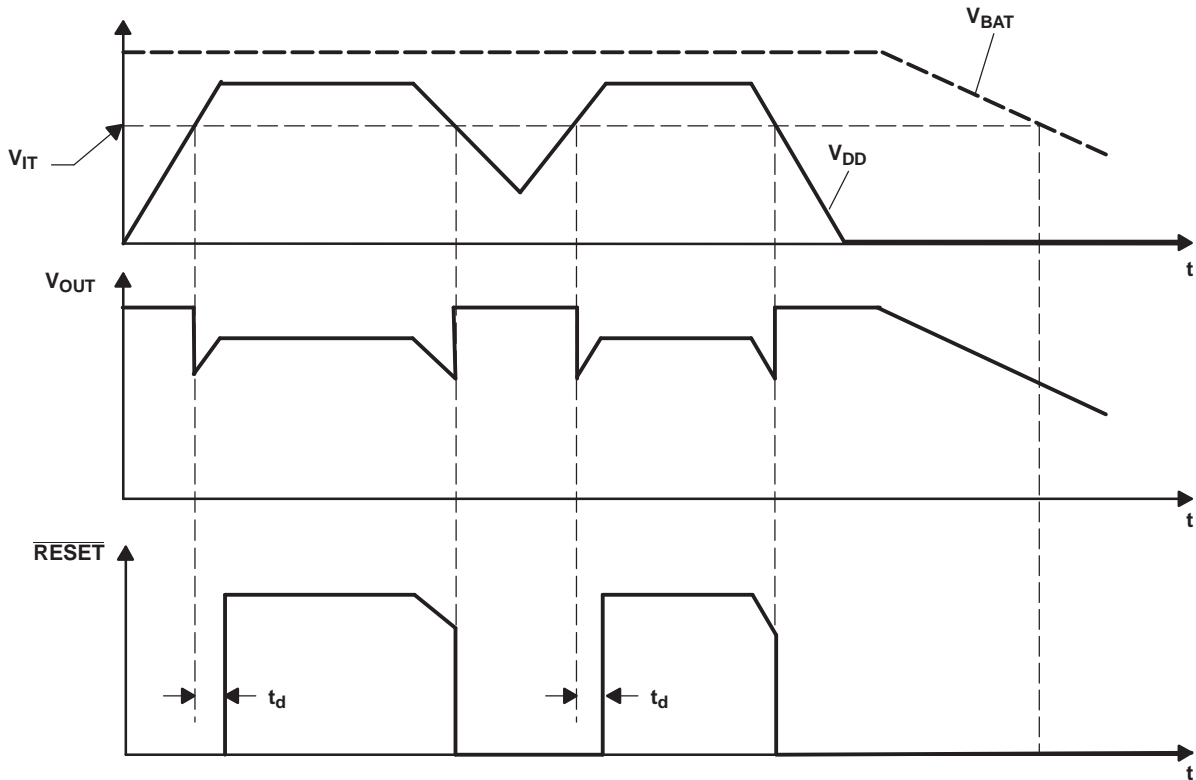

**Table 1. FUNCTION TABLE**

$V_{DD} > V_{IT}$	$V_{DD} > V_{BAT}$	$\overline{MR}$	$V_{OUT}$	RESET
0	0	0	$V_{BAT}$	0
0	0	1	$V_{BAT}$	0
0	1	0	$V_{DD}$	0
0	1	1	$V_{DD}$	0
1	0	0	$V_{DD}$	0
1	0	1	$V_{DD}$	1
1	1	0	$V_{DD}$	0
1	1	1	$V_{DD}$	1

$PFI > V_{PFI}$	PFO
0	0
1	1

CONDITION.:  $V_{DD} > V_{DD\_MIN}$

**Table 2. TERMINAL FUNCTIONS**

TERMINAL		I/O	DESCRIPTION
NAME	NO.		
GND	3	I	Ground
$\overline{\text{MR}}$	6	I	Manual reset input
PFI	4	I	Power-fail comparator input
$\overline{\text{PFO}}$	5	O	Power-fail comparator output
$\overline{\text{RESET}}$	7	O	Active-low reset output
$V_{\text{BAT}}$	8	I	Backup-battery input
$V_{\text{DD}}$	2	I	Input supply voltage
$V_{\text{OUT}}$	1	O	Supply output

**FUNCTIONAL BLOCK DIAGRAM**

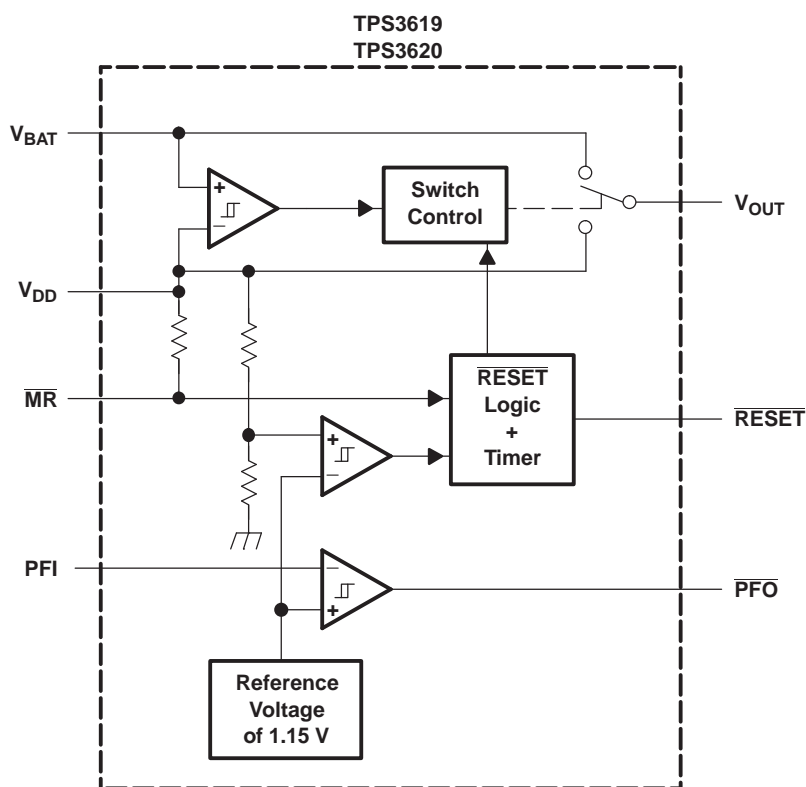

## TYPICAL CHARACTERISTICS

STATIC DRAIN-SOURCE ON-STATE RESISTANCE  
( $V_{DD}$  to  $V_{OUT}$ )  
vs  
OUTPUT CURRENT

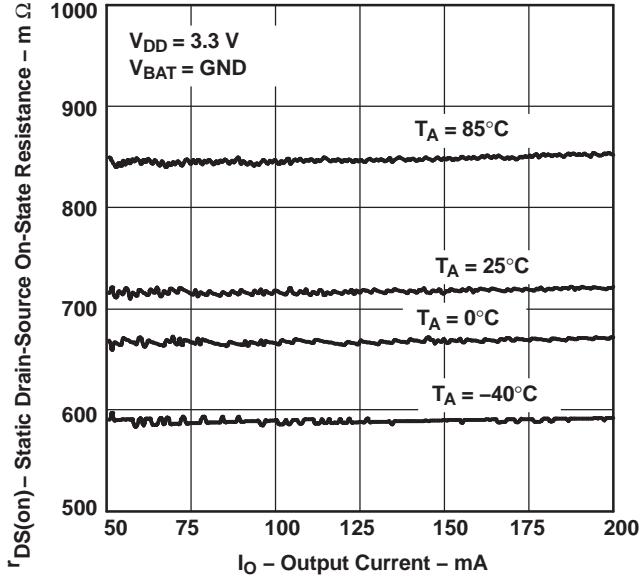

Figure 1.

STATIC DRAIN-SOURCE ON-STATE RESISTANCE  
( $V_{BAT}$  to  $V_{OUT}$ )  
vs  
OUTPUT CURRENT

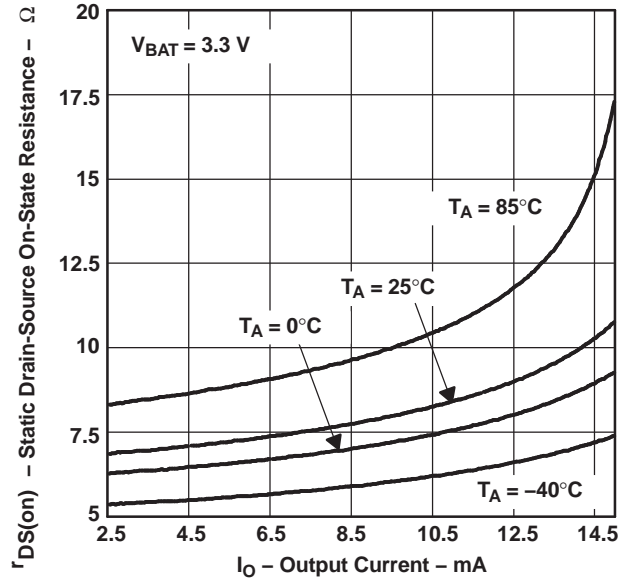

Figure 2.

SUPPLY CURRENT  
vs  
SUPPLY VOLTAGE

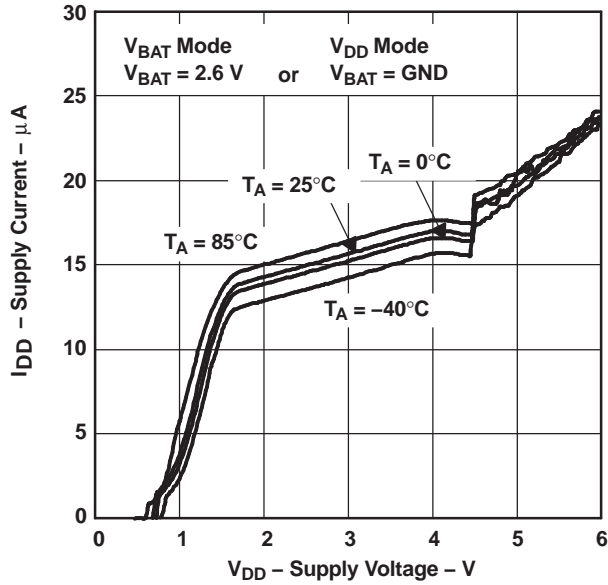

Figure 3.

NORMALIZED THRESHOLD AT RESET  
vs  
FREE-AIR TEMPERATURE

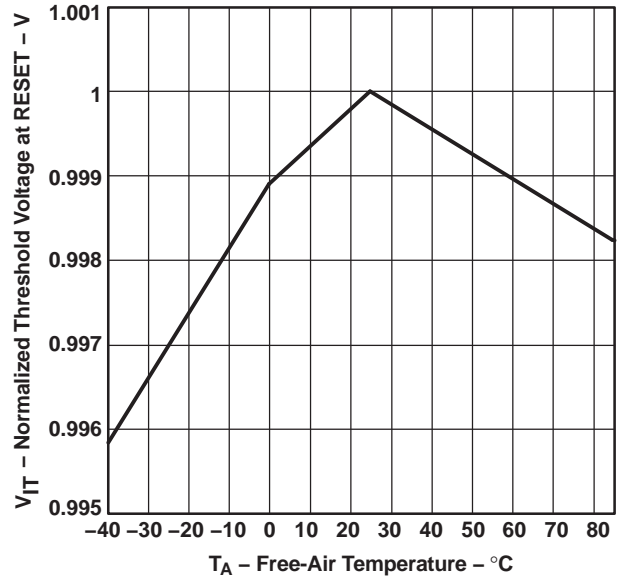

Figure 4.

TYPICAL CHARACTERISTICS (continued)

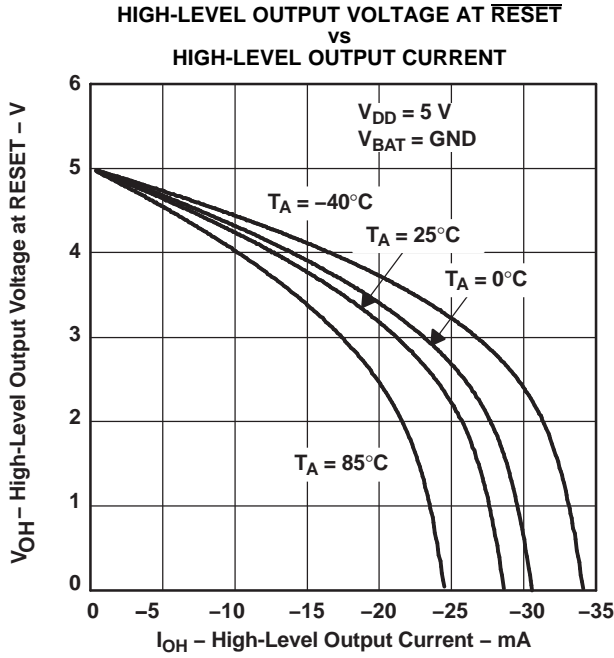

Figure 5.

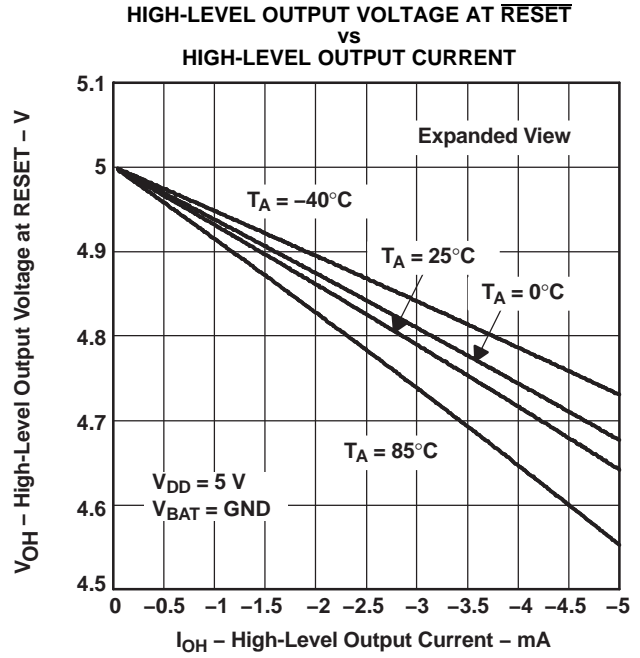

Figure 6.

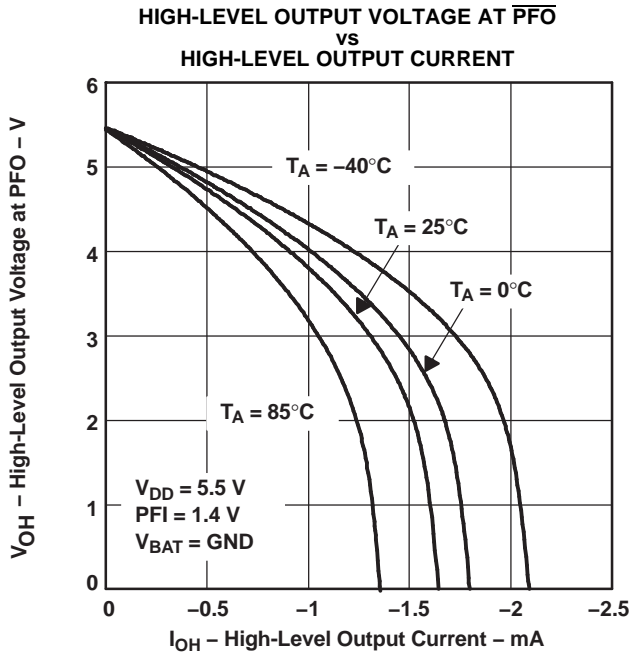

Figure 7.

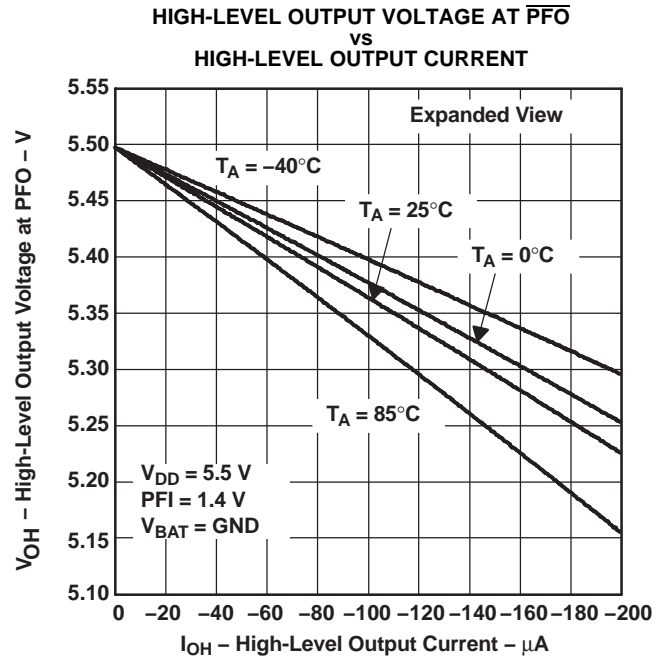

Figure 8.



TYPICAL CHARACTERISTICS (continued)

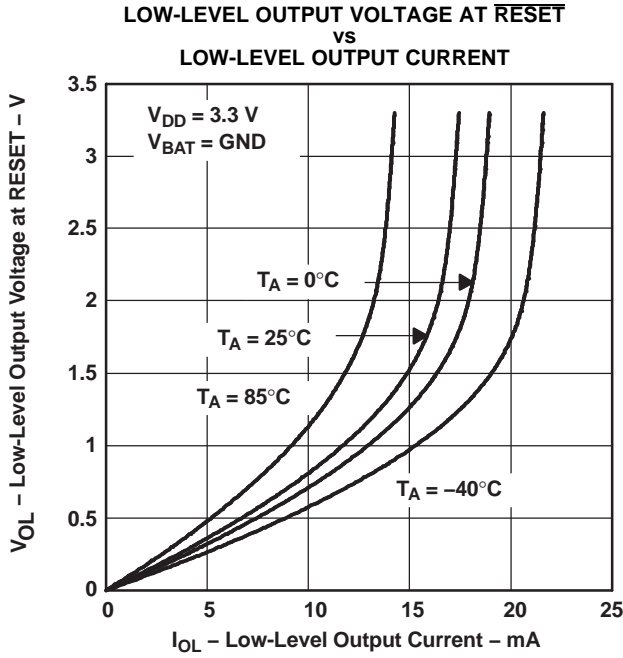

Figure 9.

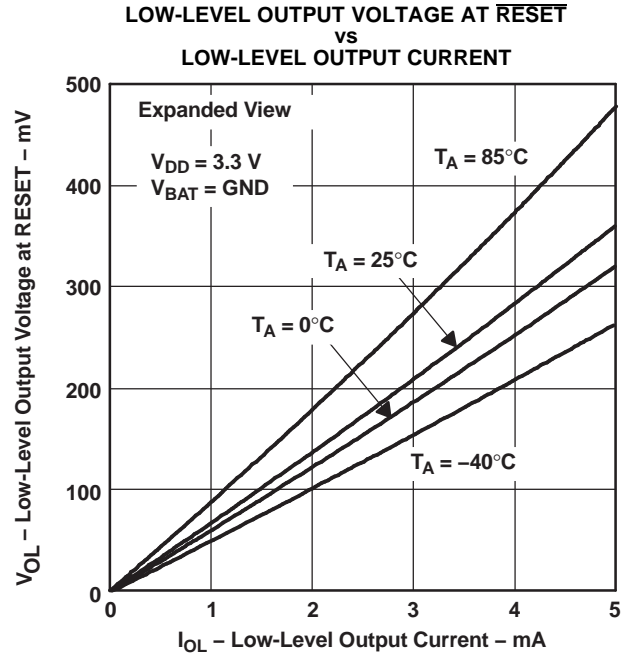

Figure 10.

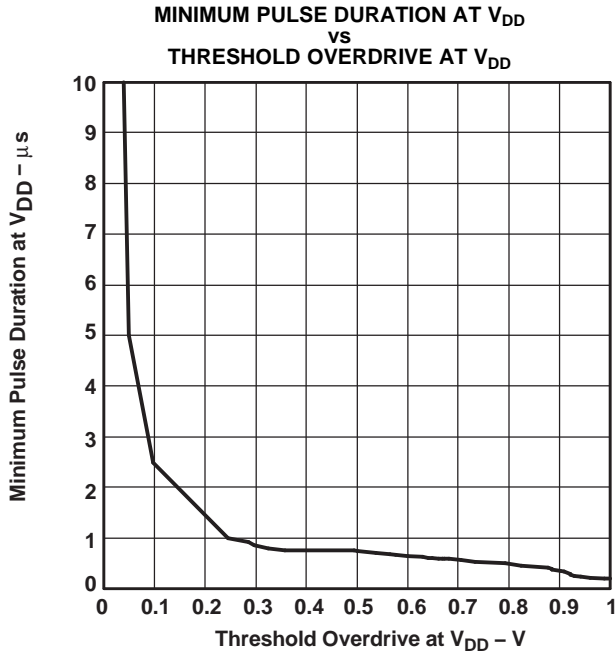

Figure 11.

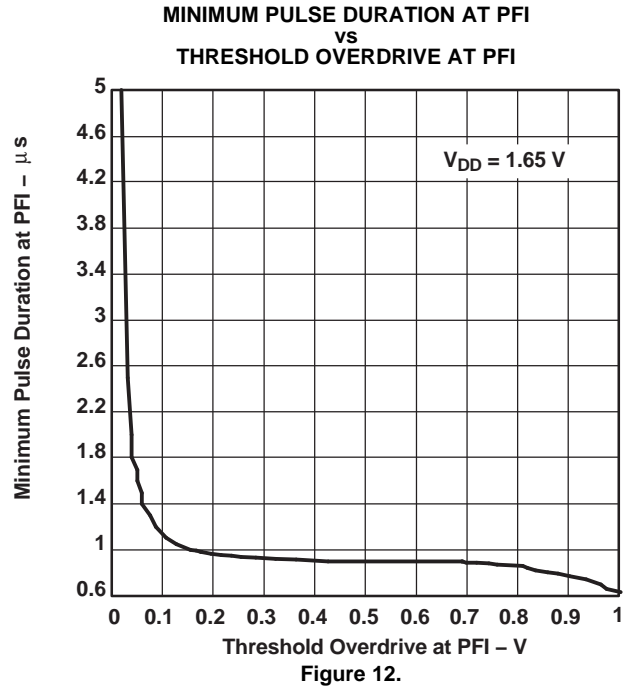

Figure 12.

## DETAILED DESCRIPTION

### Battery Freshness Seal (TPS3619)

The battery freshness seal of the TPS3619 family disconnects the backup-battery from internal circuitry until it is needed. This function prevents the backup-battery from being discharged until the final product is put to use. The following steps explain how to enable the freshness seal mode.

1. Connect  $V_{BAT}$  ( $V_{BAT} > V_{BAT\ min}$ )
2. Ground  $\overline{PFO}$
3. Connect PFI to  $V_{DD}$  ( $PFI = V_{DD}$ )
4. Connect  $V_{DD}$  to power supply ( $V_{DD} > V_{IT}$ ) and keep connected for  $5\ ms < t < 35\ ms$

The battery freshness seal mode is automatically removed by the positive-going edge of  $\overline{RESET}$  when  $V_{DD}$  is applied.

### Power-Fail Comparator (PFI and $\overline{PFO}$ )

An additional comparator is provided to monitor voltages other than the nominal supply voltage. The power-fail-input (PFI) is compared with an internal voltage reference of 1.15 V. If the input voltage falls below the power-fail threshold  $V_{IT(PFI)}$  of typical 1.15 V, the power-fail output ( $\overline{PFO}$ ) goes low. If  $V_{IT(PFI)}$  goes above  $V_{(PFI)}$ , plus about 12-mV hysteresis, the output returns to high. By connecting two external resistors, it is possible to supervise any voltages above  $V_{(PFI)}$ . The sum of both resistors should be about 1 M $\Omega$ , to minimize power consumption and also to assure that the current in the PFI pin can be ignored compared with the current through the resistor network. The tolerance of the external resistors should be not more than 1% to ensure minimal variation of sensed voltage. If the power-fail comparator is unused, PFI should be connected to ground and  $\overline{PFO}$  left unconnected.

### Backup-Battery Switchover

In case of a brownout or power failure, it may be necessary to preserve the contents of RAM. If a backup battery is installed at  $V_{BAT}$ , the device automatically switches the connected RAM to backup power when  $V_{DD}$  fails. In order to allow the backup battery (e.g., a 3.6-V lithium cell) to have a higher voltage than  $V_{DD}$ , these supervisors do not connect  $V_{BAT}$  to  $V_{OUT}$  when  $V_{BAT}$  is greater than  $V_{DD}$ .  $V_{BAT}$  only connects to  $V_{OUT}$  (through a 15- $\Omega$  switch) when  $V_{DD}$  falls below  $V_{IT}$  and  $V_{BAT}$  is greater than  $V_{DD}$ . When  $V_{DD}$  recovers, switchover is deferred either until  $V_{DD}$  crosses  $V_{BAT}$ , or until  $V_{DD}$  rises above the reset threshold  $V_{IT}$ .  $V_{OUT}$  connects to  $V_{DD}$  through a 1- $\Omega$  (max) PMOS switch when  $V_{DD}$  crosses the reset threshold.

FUNCTION TABLE		
$V_{DD} > V_{BAT}$	$V_{DD} > V_{IT}$	$V_{OUT}$
1	1	$V_{DD}$
1	0	$V_{DD}$
0	1	$V_{DD}$
0	0	$V_{BAT}$

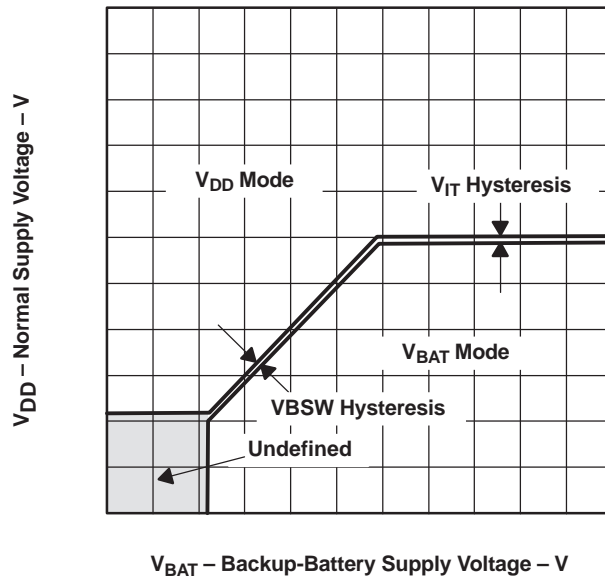

**Figure 13. Normal Supply Voltage vs Backup-Battery Supply Voltage**

**PACKAGING INFORMATION**

Orderable Device	Status <sup>(1)</sup>	Package Type	Package Drawing	Pins	Package Qty	Eco Plan <sup>(2)</sup>	Lead/ Ball Finish	MSL Peak Temp <sup>(3)</sup>	Samples (Requires Login)
TPS3619-33DGK	ACTIVE	VSSOP	DGK	8	80	Green (RoHS & no Sb/Br)	CU NIPDAU	Level-1-260C-UNLIM	
TPS3619-33DGKG4	ACTIVE	VSSOP	DGK	8	80	Green (RoHS & no Sb/Br)	CU NIPDAU	Level-1-260C-UNLIM	
TPS3619-33DGKR	ACTIVE	VSSOP	DGK	8	2500	Green (RoHS & no Sb/Br)	CU NIPDAU	Level-1-260C-UNLIM	
TPS3619-33DGKRG4	ACTIVE	VSSOP	DGK	8	2500	Green (RoHS & no Sb/Br)	CU NIPDAU	Level-1-260C-UNLIM	
TPS3619-50DGK	ACTIVE	VSSOP	DGK	8	80	Green (RoHS & no Sb/Br)	CU NIPDAU	Level-1-260C-UNLIM	
TPS3619-50DGKG4	ACTIVE	VSSOP	DGK	8	80	Green (RoHS & no Sb/Br)	CU NIPDAU	Level-1-260C-UNLIM	
TPS3619-50DGKR	ACTIVE	VSSOP	DGK	8	2500	Green (RoHS & no Sb/Br)	CU NIPDAU	Level-1-260C-UNLIM	
TPS3619-50DGKRG4	ACTIVE	VSSOP	DGK	8	2500	Green (RoHS & no Sb/Br)	CU NIPDAU	Level-1-260C-UNLIM	
TPS3620-33DGKR	ACTIVE	VSSOP	DGK	8	2500	Green (RoHS & no Sb/Br)	CU NIPDAU	Level-1-260C-UNLIM	
TPS3620-33DGKRG4	ACTIVE	VSSOP	DGK	8	2500	Green (RoHS & no Sb/Br)	CU NIPDAU	Level-1-260C-UNLIM	
TPS3620-33DGKT	ACTIVE	VSSOP	DGK	8	250	Green (RoHS & no Sb/Br)	CU NIPDAU	Level-1-260C-UNLIM	
TPS3620-33DGKTG4	ACTIVE	VSSOP	DGK	8	250	Green (RoHS & no Sb/Br)	CU NIPDAU	Level-1-260C-UNLIM	
TPS3620-50DGKR	ACTIVE	VSSOP	DGK	8	2500	Green (RoHS & no Sb/Br)	CU NIPDAU	Level-1-260C-UNLIM	
TPS3620-50DGKRG4	ACTIVE	VSSOP	DGK	8	2500	Green (RoHS & no Sb/Br)	CU NIPDAU	Level-1-260C-UNLIM	
TPS3620-50DGKT	ACTIVE	VSSOP	DGK	8	250	Green (RoHS & no Sb/Br)	CU NIPDAU	Level-1-260C-UNLIM	
TPS3620-50DGKTG4	ACTIVE	VSSOP	DGK	8	250	Green (RoHS & no Sb/Br)	CU NIPDAU	Level-1-260C-UNLIM	

<sup>(1)</sup> The marketing status values are defined as follows:

---

**ACTIVE:** Product device recommended for new designs.

**LIFEBUY:** TI has announced that the device will be discontinued, and a lifetime-buy period is in effect.

**NRND:** Not recommended for new designs. Device is in production to support existing customers, but TI does not recommend using this part in a new design.

**PREVIEW:** Device has been announced but is not in production. Samples may or may not be available.

**OBSOLETE:** TI has discontinued the production of the device.

<sup>(2)</sup> Eco Plan - The planned eco-friendly classification: Pb-Free (RoHS), Pb-Free (RoHS Exempt), or Green (RoHS & no Sb/Br) - please check <http://www.ti.com/productcontent> for the latest availability information and additional product content details.

**TBD:** The Pb-Free/Green conversion plan has not been defined.

**Pb-Free (RoHS):** TI's terms "Lead-Free" or "Pb-Free" mean semiconductor products that are compatible with the current RoHS requirements for all 6 substances, including the requirement that lead not exceed 0.1% by weight in homogeneous materials. Where designed to be soldered at high temperatures, TI Pb-Free products are suitable for use in specified lead-free processes.

**Pb-Free (RoHS Exempt):** This component has a RoHS exemption for either 1) lead-based flip-chip solder bumps used between the die and package, or 2) lead-based die adhesive used between the die and leadframe. The component is otherwise considered Pb-Free (RoHS compatible) as defined above.

**Green (RoHS & no Sb/Br):** TI defines "Green" to mean Pb-Free (RoHS compatible), and free of Bromine (Br) and Antimony (Sb) based flame retardants (Br or Sb do not exceed 0.1% by weight in homogeneous material)

<sup>(3)</sup> MSL, Peak Temp. -- The Moisture Sensitivity Level rating according to the JEDEC industry standard classifications, and peak solder temperature.

**Important Information and Disclaimer:** The information provided on this page represents TI's knowledge and belief as of the date that it is provided. TI bases its knowledge and belief on information provided by third parties, and makes no representation or warranty as to the accuracy of such information. Efforts are underway to better integrate information from third parties. TI has taken and continues to take reasonable steps to provide representative and accurate information but may not have conducted destructive testing or chemical analysis on incoming materials and chemicals. TI and TI suppliers consider certain information to be proprietary, and thus CAS numbers and other limited information may not be available for release.

In no event shall TI's liability arising out of such information exceed the total purchase price of the TI part(s) at issue in this document sold by TI to Customer on an annual basis.

**OTHER QUALIFIED VERSIONS OF TPS3619-33, TPS3620-33 :**

- Enhanced Product: [TPS3619-33-EP](#), [TPS3620-33-EP](#)

NOTE: Qualified Version Definitions:

- Enhanced Product - Supports Defense, Aerospace and Medical Applications

**TAPE AND REEL INFORMATION**
**REEL DIMENSIONS**

**TAPE DIMENSIONS**

A0	Dimension designed to accommodate the component width
B0	Dimension designed to accommodate the component length
K0	Dimension designed to accommodate the component thickness
W	Overall width of the carrier tape
P1	Pitch between successive cavity centers

**TAPE AND REEL INFORMATION**

\*All dimensions are nominal

Device	Package Type	Package Drawing	Pins	SPQ	Reel Diameter (mm)	Reel Width W1 (mm)	A0 (mm)	B0 (mm)	K0 (mm)	P1 (mm)	W (mm)	Pin1 Quadrant
TPS3619-33DGKR	VSSOP	DGK	8	2500	330.0	12.4	5.3	3.4	1.4	8.0	12.0	Q1
TPS3619-50DGKR	VSSOP	DGK	8	2500	330.0	12.4	5.3	3.4	1.4	8.0	12.0	Q1
TPS3620-33DGKR	VSSOP	DGK	8	2500	330.0	12.4	5.3	3.4	1.4	8.0	12.0	Q1
TPS3620-33DGKT	VSSOP	DGK	8	250	330.0	12.4	5.3	3.4	1.4	8.0	12.0	Q1
TPS3620-50DGKR	VSSOP	DGK	8	2500	330.0	12.4	5.3	3.4	1.4	8.0	12.0	Q1
TPS3620-50DGKT	VSSOP	DGK	8	250	330.0	12.4	5.3	3.4	1.4	8.0	12.0	Q1

**TAPE AND REEL BOX DIMENSIONS**

\*All dimensions are nominal

Device	Package Type	Package Drawing	Pins	SPQ	Length (mm)	Width (mm)	Height (mm)
TPS3619-33DGKR	VSSOP	DGK	8	2500	358.0	335.0	35.0
TPS3619-50DGKR	VSSOP	DGK	8	2500	358.0	335.0	35.0
TPS3620-33DGKR	VSSOP	DGK	8	2500	358.0	335.0	35.0
TPS3620-33DGKT	VSSOP	DGK	8	250	358.0	335.0	35.0
TPS3620-50DGKR	VSSOP	DGK	8	2500	358.0	335.0	35.0
TPS3620-50DGKT	VSSOP	DGK	8	250	358.0	335.0	35.0

DGK (S-PDSO-G8)

PLASTIC SMALL-OUTLINE PACKAGE



- NOTES:
- A. All linear dimensions are in millimeters.
  - B. This drawing is subject to change without notice.
  - C. Body length does not include mold flash, protrusions, or gate burrs. Mold flash, protrusions, or gate burrs shall not exceed 0.15 per end.
  - D. Body width does not include interlead flash. Interlead flash shall not exceed 0.50 per side.
  - E. Falls within JEDEC MO-187 variation AA, except interlead flash.



## IMPORTANT NOTICE

Texas Instruments Incorporated and its subsidiaries (TI) reserve the right to make corrections, enhancements, improvements and other changes to its semiconductor products and services per JESD46C and to discontinue any product or service per JESD48B. Buyers should obtain the latest relevant information before placing orders and should verify that such information is current and complete. All semiconductor products (also referred to herein as "components") are sold subject to TI's terms and conditions of sale supplied at the time of order acknowledgment.

TI warrants performance of its components to the specifications applicable at the time of sale, in accordance with the warranty in TI's terms and conditions of sale of semiconductor products. Testing and other quality control techniques are used to the extent TI deems necessary to support this warranty. Except where mandated by applicable law, testing of all parameters of each component is not necessarily performed.

TI assumes no liability for applications assistance or the design of Buyers' products. Buyers are responsible for their products and applications using TI components. To minimize the risks associated with Buyers' products and applications, Buyers should provide adequate design and operating safeguards.

TI does not warrant or represent that any license, either express or implied, is granted under any patent right, copyright, mask work right, or other intellectual property right relating to any combination, machine, or process in which TI components or services are used. Information published by TI regarding third-party products or services does not constitute a license to use such products or services or a warranty or endorsement thereof. Use of such information may require a license from a third party under the patents or other intellectual property of the third party, or a license from TI under the patents or other intellectual property of TI.

Reproduction of significant portions of TI information in TI data books or data sheets is permissible only if reproduction is without alteration and is accompanied by all associated warranties, conditions, limitations, and notices. TI is not responsible or liable for such altered documentation. Information of third parties may be subject to additional restrictions.

Resale of TI components or services with statements different from or beyond the parameters stated by TI for that component or service voids all express and any implied warranties for the associated TI component or service and is an unfair and deceptive business practice. TI is not responsible or liable for any such statements.

Buyer acknowledges and agrees that it is solely responsible for compliance with all legal, regulatory and safety-related requirements concerning its products, and any use of TI components in its applications, notwithstanding any applications-related information or support that may be provided by TI. Buyer represents and agrees that it has all the necessary expertise to create and implement safeguards which anticipate dangerous consequences of failures, monitor failures and their consequences, lessen the likelihood of failures that might cause harm and take appropriate remedial actions. Buyer will fully indemnify TI and its representatives against any damages arising out of the use of any TI components in safety-critical applications.

In some cases, TI components may be promoted specifically to facilitate safety-related applications. With such components, TI's goal is to help enable customers to design and create their own end-product solutions that meet applicable functional safety standards and requirements. Nonetheless, such components are subject to these terms.

No TI components are authorized for use in FDA Class III (or similar life-critical medical equipment) unless authorized officers of the parties have executed a special agreement specifically governing such use.

Only those TI components which TI has specifically designated as military grade or "enhanced plastic" are designed and intended for use in military/aerospace applications or environments. Buyer acknowledges and agrees that any military or aerospace use of TI components which have **not** been so designated is solely at the Buyer's risk, and that Buyer is solely responsible for compliance with all legal and regulatory requirements in connection with such use.

TI has specifically designated certain components which meet ISO/TS16949 requirements, mainly for automotive use. Components which have not been so designated are neither designed nor intended for automotive use; and TI will not be responsible for any failure of such components to meet such requirements.

### Products

Audio	<a href="http://www.ti.com/audio">www.ti.com/audio</a>
Amplifiers	<a href="http://amplifier.ti.com">amplifier.ti.com</a>
Data Converters	<a href="http://dataconverter.ti.com">dataconverter.ti.com</a>
DLP® Products	<a href="http://www.dlp.com">www.dlp.com</a>
DSP	<a href="http://dsp.ti.com">dsp.ti.com</a>
Clocks and Timers	<a href="http://www.ti.com/clocks">www.ti.com/clocks</a>
Interface	<a href="http://interface.ti.com">interface.ti.com</a>
Logic	<a href="http://logic.ti.com">logic.ti.com</a>
Power Mgmt	<a href="http://power.ti.com">power.ti.com</a>
Microcontrollers	<a href="http://microcontroller.ti.com">microcontroller.ti.com</a>
RFID	<a href="http://www.ti-rfid.com">www.ti-rfid.com</a>
OMAP Mobile Processors	<a href="http://www.ti.com/omap">www.ti.com/omap</a>
Wireless Connectivity	<a href="http://www.ti.com/wirelessconnectivity">www.ti.com/wirelessconnectivity</a>

### Applications

Automotive and Transportation	<a href="http://www.ti.com/automotive">www.ti.com/automotive</a>
Communications and Telecom	<a href="http://www.ti.com/communications">www.ti.com/communications</a>
Computers and Peripherals	<a href="http://www.ti.com/computers">www.ti.com/computers</a>
Consumer Electronics	<a href="http://www.ti.com/consumer-apps">www.ti.com/consumer-apps</a>
Energy and Lighting	<a href="http://www.ti.com/energy">www.ti.com/energy</a>
Industrial	<a href="http://www.ti.com/industrial">www.ti.com/industrial</a>
Medical	<a href="http://www.ti.com/medical">www.ti.com/medical</a>
Security	<a href="http://www.ti.com/security">www.ti.com/security</a>
Space, Avionics and Defense	<a href="http://www.ti.com/space-avionics-defense">www.ti.com/space-avionics-defense</a>
Video and Imaging	<a href="http://www.ti.com/video">www.ti.com/video</a>

**TI E2E Community** [e2e.ti.com](http://e2e.ti.com)