

# 150-mA, Low-Dropout Regulator with Foldback Current Limit for Portable Devices

Check for Samples: [TLV717xx](#), [TLV717xxP](#)

## FEATURES

- **Very Low Dropout: 215 mV at 150 mA**
- **Accuracy: 0.5% (typical)**
- **Low  $I_Q$ : 35  $\mu$ A**
- **Available in Fixed-Output Voltages: 1.2 V to 5.0 V<sup>(1)</sup>**
- **High PSRR:**
  - 70 dB at 1 kHz
  - 50 dB at 1 MHz
- **Stable with Effective Output Capacitance: 0.1  $\mu$ F<sup>(2)</sup>**
- **Foldback Current Limit**
- **Package: 1-mm x 1-mm DQN**

- (1) See the Package Option Addendum at the end of this document for a complete list of available voltage options.
- (2) See the [Input and Output Capacitor Requirements](#) section in the [Application Information](#) for more details.

## APPLICATIONS

- **Wireless Handsets, Smart Phones, PDAs**
- **MP3 Players**
- **Other Hand-Held Products**

TLV717xx  
1-mm x 1-mm DQN  
(Bottom View)

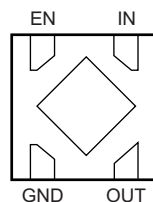

## DESCRIPTION

The TLV717xx series of low-dropout (LDO) linear regulators are low quiescent current LDOs with excellent line and load transient performance and are designed for power-sensitive applications. These devices provide a typical accuracy of 0.5%.

The TLV717xx series offer current foldback that throttles down the output current with a decrease in load resistance. The typical value at which current foldback initiates is 350 mA; the typical value of the output short current limit value is 40 mA.

Furthermore, these devices are stable with an effective output capacitance of only 0.1  $\mu$ F. This feature enables the use of cost-effective capacitors that have higher bias voltages and temperature derating. The devices regulate to specified accuracy with no output load.

The TLV717xx series is available in a 1-mm x 1-mm DQN package that makes them ideal for hand-held applications. The TLV717xxP provides an active pull-down circuit to quickly discharge output loads.

## Typical Application Circuit

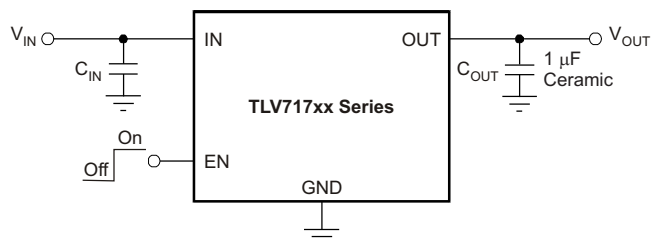

Please be aware that an important notice concerning availability, standard warranty, and use in critical applications of Texas Instruments semiconductor products and disclaimers thereto appears at the end of this data sheet.

All trademarks are the property of their respective owners.



This integrated circuit can be damaged by ESD. Texas Instruments recommends that all integrated circuits be handled with appropriate precautions. Failure to observe proper handling and installation procedures can cause damage.

ESD damage can range from subtle performance degradation to complete device failure. Precision integrated circuits may be more susceptible to damage because very small parametric changes could cause the device not to meet its published specifications.

### ORDERING INFORMATION<sup>(1)</sup>

PRODUCT	V <sub>OUT</sub>
TLV717xx(x)Pyyyz	<p><b>XX(X)</b> is the nominal output voltage. For output voltages with a resolution of 100 mV, two digits are used in the ordering number; otherwise, three digits are used (for example, 28 = 2.8 V; 475 = 4.75 V).</p> <p><b>P</b> is optional; devices with P have an LDO regulator with an active output discharge.</p> <p><b>YYY</b> is the package designator.</p> <p><b>Z</b> is the package quantity. R is for reel (3000 pieces), T is for tape (250 pieces).</p>

(1) For the most current package and ordering information see the Package Option Addendum at the end of this document, or visit the device product folder on [www.ti.com](http://www.ti.com).

### ABSOLUTE MAXIMUM RATINGS<sup>(1)</sup>

At T<sub>J</sub> = –25°C, unless otherwise noted. All voltages are with respect to GND.

		VALUE		UNIT
		MIN	MAX	
Voltage	Input range, V <sub>IN</sub>	–0.3	6.0	V
	Enable range, V <sub>EN</sub>	–0.3	V <sub>IN</sub> + 0.3	V
	Output range, V <sub>OUT</sub>	–0.3	6.0	V
Current	Maximum output, I <sub>OUT</sub>	Internally limited		
Output short-circuit duration		Indefinite		
Continuous total power dissipation, P <sub>DISS</sub>		See <a href="#">Thermal Information</a> table		
Temperature	Junction range, T <sub>J</sub>	–55	+150	°C
	Storage junction range, T <sub>stg</sub>	–55	+150	°C
Electrostatic discharge (ESD) ratings	Human body model (HBM)		2000	V
	Charged device model (CDM)		500	V

(1) Stresses beyond those listed under *Absolute Maximum Ratings* may cause permanent damage to the device. These are stress ratings only, and functional operation of the device at these or any other conditions beyond those indicated is not implied. Exposure to absolute-maximum rated conditions for extended periods may affect device reliability.

### THERMAL INFORMATION

THERMAL METRIC <sup>(1)</sup>		TLV717xx TLV717xxP	UNITS
		DQN 4 PINS	
θ <sub>JA</sub>	Junction-to-ambient thermal resistance	393.3	°C/W
θ <sub>JC(top)</sub>	Junction-to-case(top) thermal resistance	140.3	
θ <sub>JB</sub>	Junction-to-board thermal resistance	330	
ψ <sub>JT</sub>	Junction-to-top characterization parameter	6.5	
ψ <sub>JB</sub>	Junction-to-board characterization parameter	329	
θ <sub>JC(bottom)</sub>	Junction-to-case(bottom) thermal resistance	147.5	

(1) For more information about traditional and new thermal metrics, see the *IC Package Thermal Metrics* application report, [SPRA953](#).

## ELECTRICAL CHARACTERISTICS

At operating temperature range ( $T_A = -40^{\circ}\text{C}$  to  $+85^{\circ}\text{C}$ ),  $T_A = +25^{\circ}\text{C}$ ,  $V_{IN} = V_{OUT(NOM)} + 0.5\text{ V}$  or  $1.7\text{ V}$  (whichever is greater),  $I_{OUT} = 10\text{ mA}$ ,  $V_{EN} = V_{IN}$ , and  $C_{OUT} = 1\text{ }\mu\text{F}$ , unless otherwise noted.

PARAMETER	TEST CONDITIONS	TLV717			UNIT
		MIN	TYP	MAX	
$V_{IN}$ Input voltage range		1.7		5.5	V
$V_{OUT}$ Output voltage range		1.2		5.0	V
$I_{OUT}$ Output current		150			mA
DC output accuracy	$T_A = +25^{\circ}\text{C}$		0.5		%
	$V_{OUT} \geq 1.2\text{ V}$ , $-40^{\circ}\text{C} \leq T_A \leq +85^{\circ}\text{C}$	-1.5		+1.5	%
	$V_{OUT} \leq 1.2\text{ V}$			25	mV
$\Delta V_O/V_{IN}$ Line regulation	$V_{OUT(NOM)} + 0.5\text{ V} \leq V_{IN} \leq 5.5\text{ V}$		1	5	mV
$\Delta V_O/I_{OUT}$ Load regulation	$0\text{ mA} \leq I_{OUT} \leq 150\text{ mA}$		10	20	mV
$V_{DO}$ Dropout voltage	$V_{IN} = 0.98 \times V_{OUT(NOM)}$ , $I_{OUT} = 150\text{ mA}$	$1.2\text{ V} \leq V_{OUT} < 1.5\text{ V}$	330	500	mV
		$1.5\text{ V} \leq V_{OUT} < 1.8\text{ V}$	330	450	mV
		$1.8\text{ V} \leq V_{OUT} \leq 5.0\text{ V}$	215	350	mV
$I_{GND}$ Ground pin current	$I_{OUT} = 0\text{ mA}$		35	55	$\mu\text{A}$
$I_{SHDN}$ Shutdown current	$V_{EN} \leq 0.4\text{ V}$ , $2.0\text{ V} \leq V_{IN} \leq 4.5\text{ V}$		0.1	0.5	$\mu\text{A}$
PSRR Power-supply rejection ratio	$V_{IN} = 3.3\text{ V}$ , $V_{OUT} = 2.8\text{ V}$ , $I_{OUT} = 30\text{ mA}$	$f = 10\text{ Hz}$		70	dB
		$f = 100\text{ Hz}$		70	dB
		$f = 1\text{ kHz}$		65	dB
		$f = 10\text{ kHz}$		60	dB
		$f = 100\text{ kHz}$		43	dB
$V_{NOISE}$ Output noise voltage	$BW = 100\text{ Hz to }100\text{ kHz}$ , $V_{IN} = 2.3\text{ V}$ , $V_{OUT} = 1.8\text{ V}$ , $I_{OUT} = 10\text{ mA}$		55		$\mu\text{V}_{RMS}$
$t_{STR}$ Startup time	$C_{OUT} = 1.0\text{ }\mu\text{F}$ , $I_{OUT} = 150\text{ mA}$		100		$\mu\text{s}$
$I_{SC}$ Short current limit	$V_{IN} = \min(V_{OUT(NOM)} + 1\text{ V}, 5.5\text{ V})$ , $V_{OUT} = 0\text{ V}$		40		mA
$V_{HI}$ Enable high (enabled)		0.9		$V_{IN}$	V
$V_{LO}$ Enable low (disabled)		0		0.4	V
$I_{EN}$ EN pin current	$EN = 5.5\text{ V}$		0.01		$\mu\text{A}$
$R_{PULLDOWN}$ Pull-down resistor (TLV717xxP only)			120		$\Omega$
UVLO Undervoltage lockout	$V_{IN}$ rising		1.6		V

## PIN CONFIGURATION

**DQN PACKAGE**  
1-mm x 1-mm TBD  
(Top View)

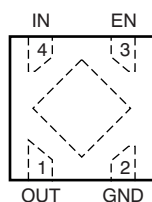

**DQN PACKAGE**  
1-mm x 1-mm TBD  
(Bottom View)

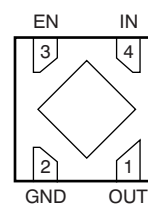

## PIN DESCRIPTIONS

PIN		DESCRIPTION
NAME	NO.	
EN	3	Enable pin. Driving EN over 1.2 V turns on the regulator. Driving EN below 0.4 V puts the regulator into shutdown mode.
GND	2	Ground pin
IN	4	Input pin. A small capacitor is recommended from this pin to ground to assure stability. See the <a href="#">Input and Output Capacitor Requirements</a> section in the <a href="#">Application Information</a> for more details.
OUT	1	Regulated output voltage pin. A small 1- $\mu$ F ceramic capacitor is recommended from this pin to ground to assure stability. See the <a href="#">Input and Output Capacitor Requirements</a> section in the <a href="#">Application Information</a> for more details.
Thermal pad	—	It is recommended to connect this pin to GND for improved thermal performance.

FUNCTIONAL BLOCK DIAGRAMS

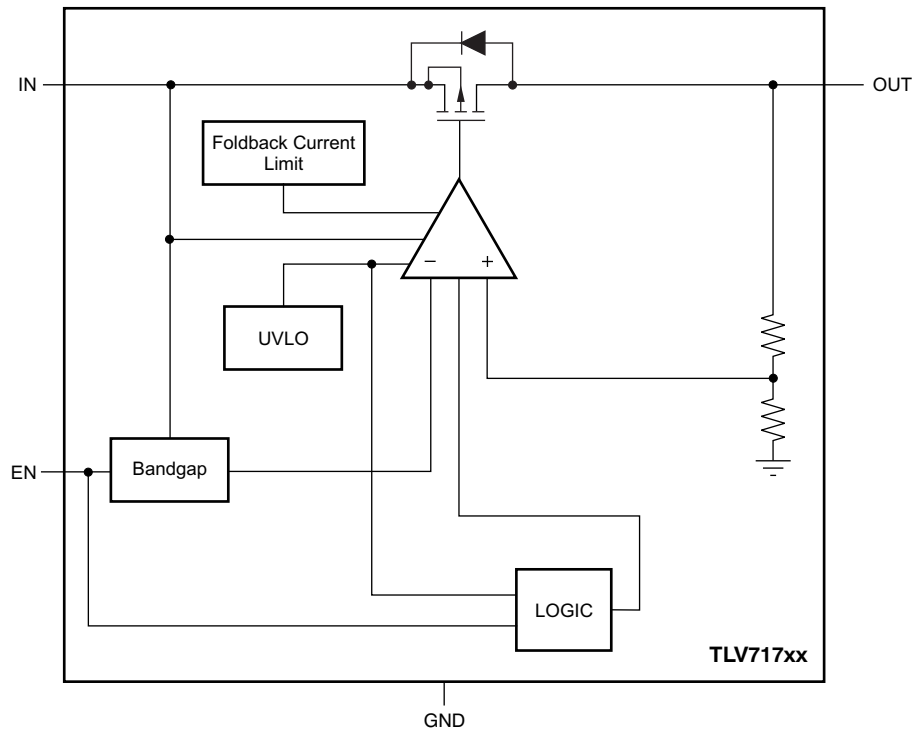

Figure 1. TLV717xx Block Diagram

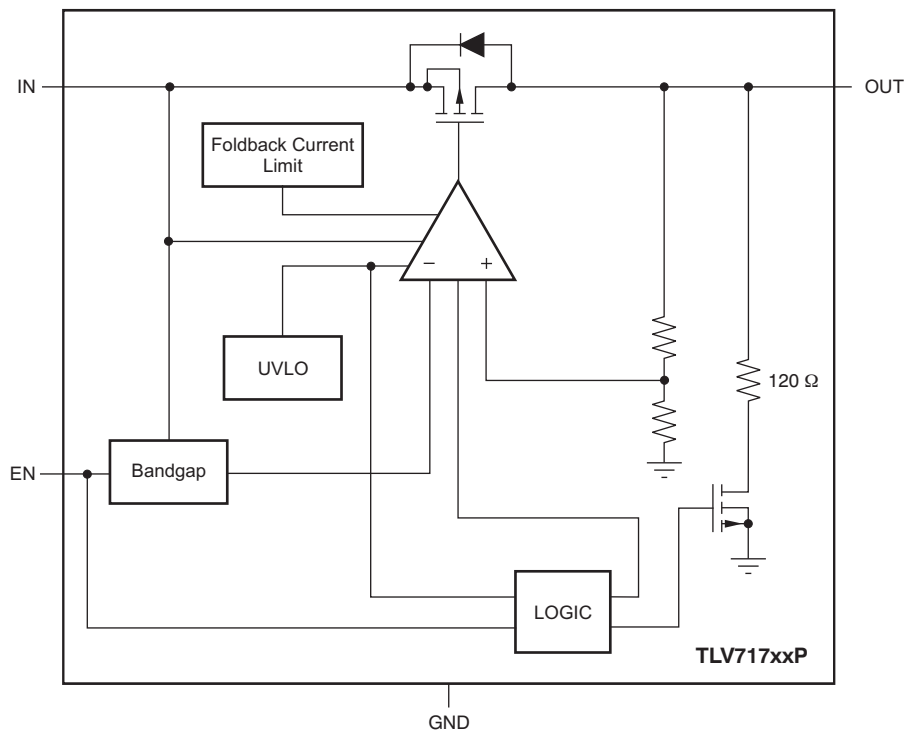
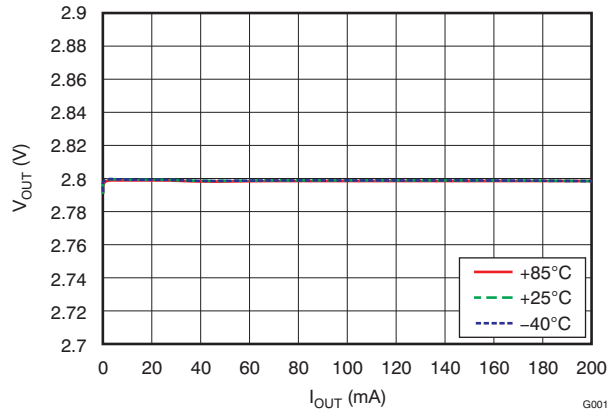

Figure 2. TLV717xxP Block Diagram

### TYPICAL CHARACTERISTICS

At operating temperature range ( $T_A = -40^\circ\text{C}$  to  $+85^\circ\text{C}$ ),  $T_A = +25^\circ\text{C}$ ,  $V_{IN} = V_{OUT(NOM)} + 0.5\text{ V}$  or  $1.7\text{ V}$  (whichever is greater),  $I_{OUT} = 10\text{ mA}$ ,  $V_{EN} = V_{IN}$ , and  $C_{OUT} = 1\text{ }\mu\text{F}$ , unless otherwise noted.

**LOAD REGULATION**



**Figure 3.**

**LINE REGULATION**

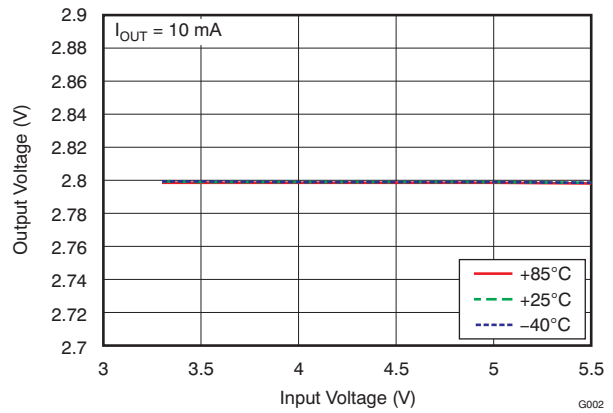

**Figure 4.**

**LINE REGULATION**

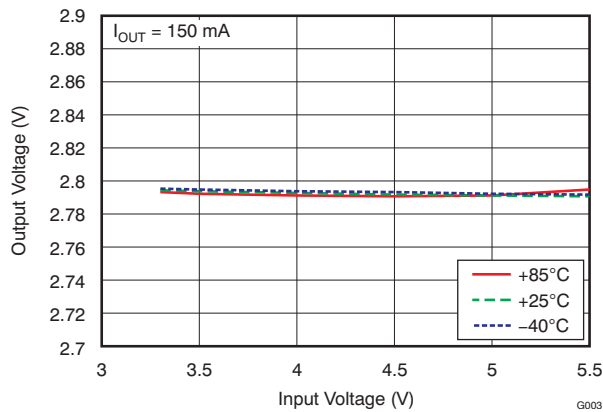

**Figure 5.**

**DROPOUT VOLTAGE vs FIXED OUTPUT VOLTAGE VERSIONS**

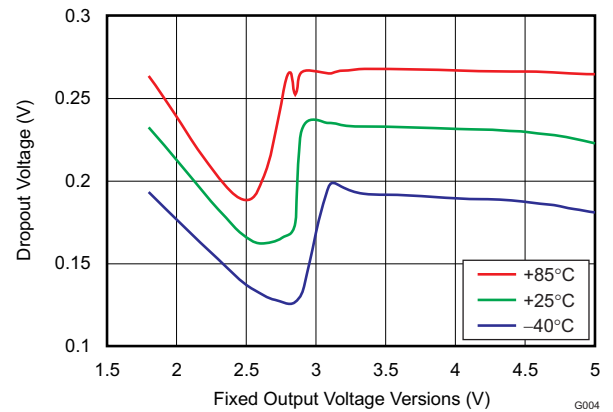

**Figure 6.**

**DROPOUT VOLTAGE vs OUTPUT CURRENT**

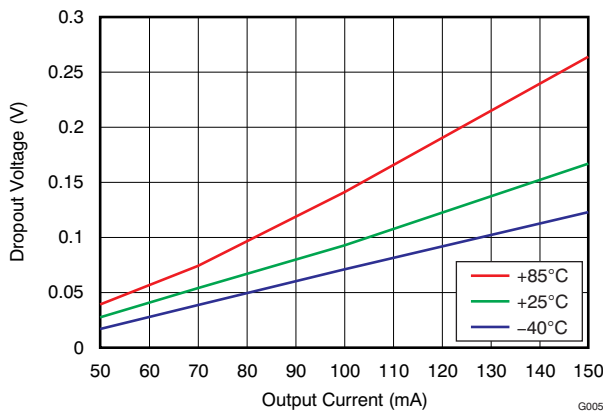

**Figure 7.**

**OUTPUT VOLTAGE vs TEMPERATURE**

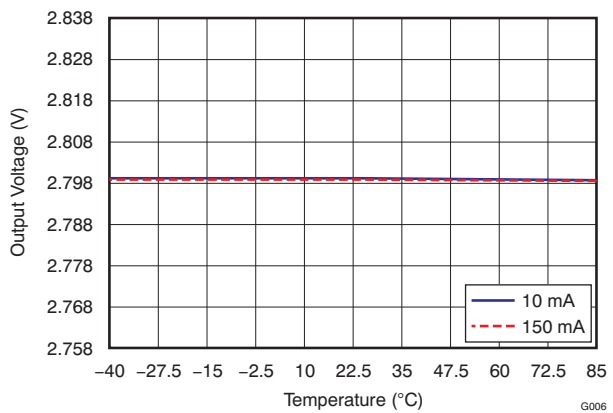

**Figure 8.**

**TYPICAL CHARACTERISTICS (continued)**

At operating temperature range ( $T_A = -40^{\circ}\text{C}$  to  $+85^{\circ}\text{C}$ ),  $T_A = +25^{\circ}\text{C}$ ,  $V_{IN} = V_{OUT(NOM)} + 0.5\text{ V}$  or  $1.7\text{ V}$  (whichever is greater),  $I_{OUT} = 10\text{ mA}$ ,  $V_{EN} = V_{IN}$ , and  $C_{OUT} = 1\text{ }\mu\text{F}$ , unless otherwise noted.

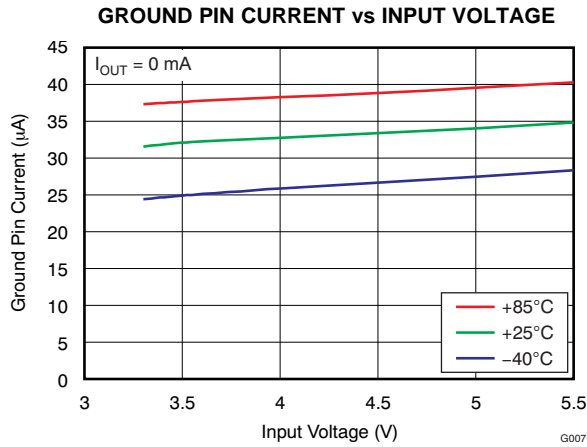

Figure 9.

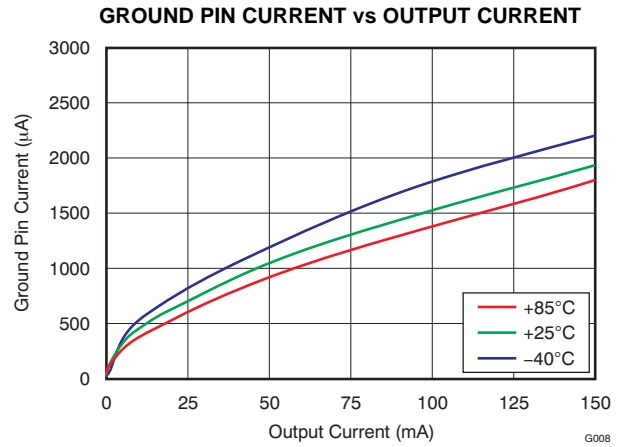

Figure 10.

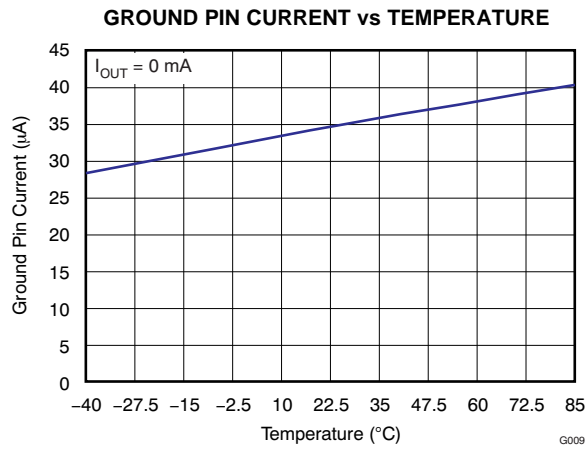

Figure 11.

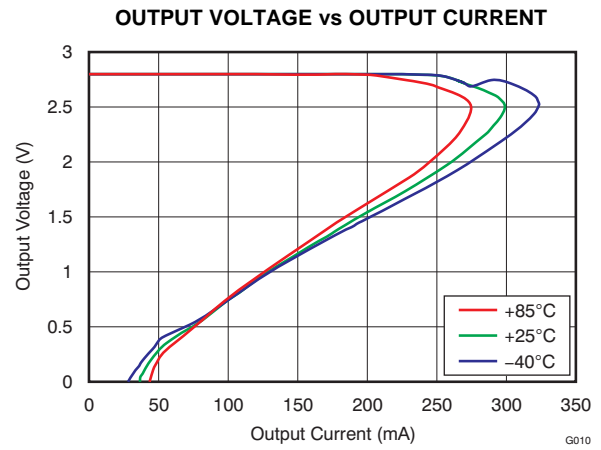

Figure 12.

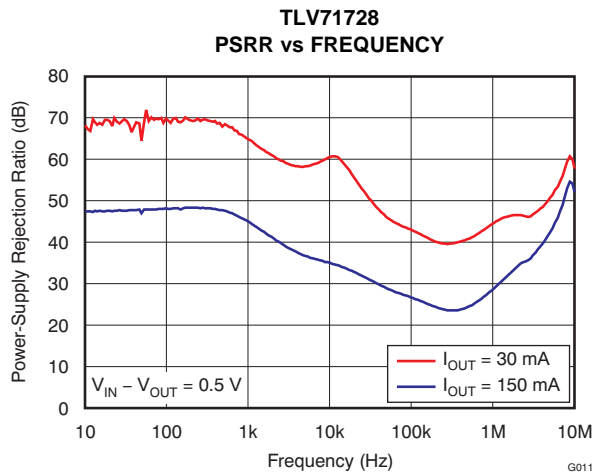

Figure 13.

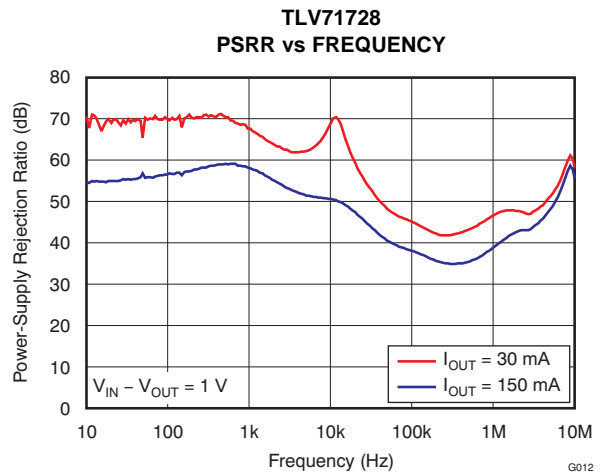

Figure 14.

### TYPICAL CHARACTERISTICS (continued)

At operating temperature range ( $T_A = -40^\circ\text{C}$  to  $+85^\circ\text{C}$ ),  $T_A = +25^\circ\text{C}$ ,  $V_{IN} = V_{OUT(NOM)} + 0.5\text{ V}$  or  $1.7\text{ V}$  (whichever is greater),  $I_{OUT} = 10\text{ mA}$ ,  $V_{EN} = V_{IN}$ , and  $C_{OUT} = 1\text{ }\mu\text{F}$ , unless otherwise noted.

PSRR vs INPUT VOLTAGE

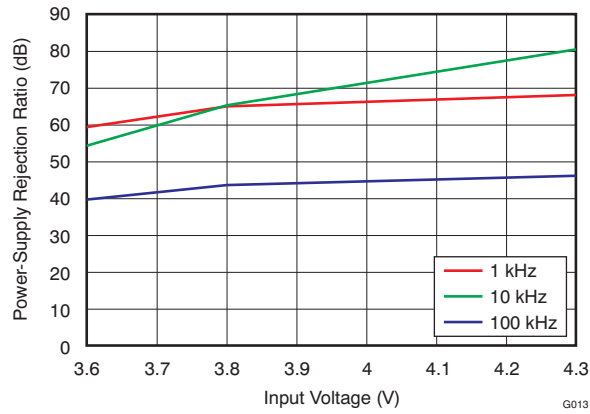

Figure 15.

OUTPUT SPECTRAL NOISE DENSITY vs FREQUENCY

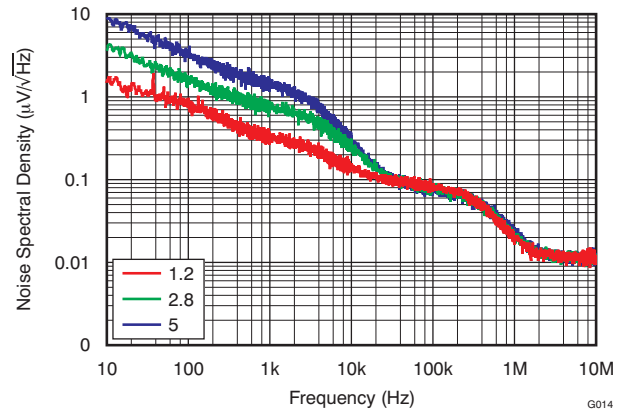

Figure 16.



## APPLICATION INFORMATION

The TLV717xx belongs to a new family of next-generation value low-dropout (LDO) regulators. These devices consume low quiescent current and deliver excellent line and load transient performance. These characteristics, combined with low noise, very good PSRR with little ( $V_{IN} - V_{OUT}$ ) headroom, make this family of devices ideal for RF portable applications.

This family of regulators offers current foldback. Device operating junction temperature is  $-40^{\circ}\text{C}$  to  $+125^{\circ}\text{C}$ .

### INPUT AND OUTPUT CAPACITOR REQUIREMENTS

X5R- and X7R-type ceramic capacitors are recommended because these capacitors have minimal variation in value and equivalent series resistance (ESR) over temperature. The TLV717xx is designed to be stable with an effective capacitance of 0.1  $\mu\text{F}$  or larger at the output, though a 1- $\mu\text{F}$  ceramic capacitor is recommended for typical applications. Thus, the device is stable with capacitors of other dielectric types as well, as long as the effective capacitance under operating bias voltage and temperature is greater than 0.1  $\mu\text{F}$ . This effective capacitance refers to the capacitance that the LDO detects under operating bias voltage and temperature conditions; that is, the capacitance after taking both bias voltage and temperature derating into consideration. In addition to allowing the use of cheaper dielectrics, this capability of being stable with 0.1- $\mu\text{F}$  effective capacitance also enables the use of smaller footprint capacitors that have higher derating in size- and space-constrained applications. Note that using a 0.1- $\mu\text{F}$  rated capacitor at the LDO output does not ensure stability because the effective capacitance under the specified operating conditions would be less than 0.1  $\mu\text{F}$ . Maximum ESR should be less than 200 m $\Omega$ .

Although an input capacitor is not required for stability, it is good analog design practice to connect a 0.1- $\mu\text{F}$  to 1.0- $\mu\text{F}$ , low ESR capacitor across the IN and GND pins of the regulator. This capacitor counteracts reactive input sources and improves transient response, noise rejection, and ripple rejection. A higher-value capacitor may be necessary if large, fast, rise-time load transients are anticipated, or if the device is not located close to the power source. If source impedance is more than 2  $\Omega$ , a 0.1- $\mu\text{F}$  input capacitor may be necessary to ensure stability.

### BOARD LAYOUT RECOMMENDATIONS TO IMPROVE PSRR AND NOISE PERFORMANCE

Input and output capacitors should be placed as close to the device pins as possible. To improve ac performance (such as PSRR, output noise, and transient response), it is recommended that the board be designed with separate ground planes for  $V_{IN}$  and  $V_{OUT}$ , with the ground plane connected only at the device GND pin. In addition, the output capacitor ground connection should be connected directly to the device GND pin. High ESR capacitors may degrade PSRR performance.

### INTERNAL CURRENT LIMIT

The TLV717xx has an internal foldback current limit that helps to protect the regulator during fault conditions. The current supplied by the device is gradually throttled down as the output voltage decreases. When the output is shorted, the LDO supplies a typical current of 40 mA. Output voltage is not regulated when the device is in current limit, and is  $V_{OUT} = I_{LIMIT} \times R_{LOAD}$ . The advantage of foldback current limit is that the  $I_{LIMIT}$  value is less than the fixed current limit. Therefore, the power that the PMOS pass transistor dissipates  $[(V_{IN} - V_{OUT}) \times I_{LIMIT}]$  is much less.

The TLV717xx PMOS pass element has a built-in body diode that conducts current when the voltage at OUT exceeds the voltage at IN. This current is not limited, so if extended reverse voltage operation is anticipated, external limiting to 5% of the rated output current is recommended.

### SHUTDOWN

The enable pin (EN) is active high. The device is enabled when the voltage at the EN pin goes above 0.9 V. This relatively lower voltage value required to turn the LDO on can be exploited to power the LDO with a GPIO of recent processors whose GPIO logic 1 voltage level is lower than traditional microcontrollers. The device is turned off when the EN pin is held at less than 0.4 V. When shutdown capability is not required, EN can be connected to the IN pin.

## DROPOUT VOLTAGE

The TLV717xx uses a PMOS pass transistor to achieve low dropout. When  $(V_{IN} - V_{OUT})$  is less than the dropout voltage ( $V_{DO}$ ), the PMOS pass device is in the linear region of operation and the input-to-output resistance is the  $R_{DS(ON)}$  of the PMOS pass element.  $V_{DO}$  scales approximately with output current because the PMOS device behaves like a resistor in dropout. As with any linear regulator, PSRR and transient response are degraded as  $(V_{IN} - V_{OUT})$  approaches dropout.

## TRANSIENT RESPONSE

As with any regulator, increasing the size of the output capacitor reduces over- and undershoot magnitude but increases the duration of the transient response.

## UNDERVOLTAGE LOCKOUT (UVLO)

The TLV717xx uses an undervoltage lockout circuit ( $UVLO = 1.6\text{ V}$ ) to keep the output shut off until the internal circuitry operates properly.

## POWER DISSIPATION

The ability to remove heat from the die is different for each package type, presenting different considerations in the printed circuit board (PCB) layout. The PCB area around the device that is free of other components moves the heat from the device to ambient air. Performance data for JEDEC-low and high-K boards are given in the [Thermal Information](#) table. Using heavier copper increases the effectiveness in removing heat from the device. The addition, plated through-holes to heat-dissipating layers also improves heatsink effectiveness.

Power dissipation depends on input voltage and load conditions. Power dissipation ( $P_D$ ) is equal to the product of the output current and the voltage drop across the output pass element, as shown in [Equation 1](#).

$$P_D = (V_{IN} - V_{OUT}) \times I_{OUT} \quad (1)$$

## REVISION HISTORY

NOTE: Page numbers for previous revisions may differ from page numbers in the current version.

### Changes from Original (October 2011) to Revision A

Page

- 
- Changed document status from Product Preview to Production Data ..... 1
-

**PACKAGING INFORMATION**

Orderable Device	Status (1)	Package Type	Package Drawing	Pins	Package Qty	Eco Plan (2)	Lead/Ball Finish	MSL Peak Temp (3)	Op Temp (°C)	Top-Side Markings (4)	Samples
TLV71712PDQNR	ACTIVE	X2SON	DQN	4	3000	Green (RoHS & no Sb/Br)	CU NIPDAU	Level-1-260C-UNLIM	-40 to 85	UX	<a href="#">Samples</a>
TLV71712PDQNR3	ACTIVE	X2SON	DQN	4	3000	Green (RoHS & no Sb/Br)	CU NIPDAU	Level-1-260C-UNLIM	-40 to 85	UX	<a href="#">Samples</a>
TLV71712PDQNT	ACTIVE	X2SON	DQN	4	250	Green (RoHS & no Sb/Br)	CU NIPDAU	Level-1-260C-UNLIM	-40 to 85	UX	<a href="#">Samples</a>
TLV71713PDQNR	ACTIVE	X2SON	DQN	4	3000	Green (RoHS & no Sb/Br)	CU NIPDAU	Level-1-260C-UNLIM	-40 to 85	VC	<a href="#">Samples</a>
TLV71713PDQNT	ACTIVE	X2SON	DQN	4	250	Green (RoHS & no Sb/Br)	CU NIPDAU	Level-1-260C-UNLIM	-40 to 85	VC	<a href="#">Samples</a>
TLV71715PDQNR	ACTIVE	X2SON	DQN	4	3000	Green (RoHS & no Sb/Br)	CU NIPDAU	Level-1-260C-UNLIM	-40 to 85	UY	<a href="#">Samples</a>
TLV71715PDQNT	ACTIVE	X2SON	DQN	4	250	Green (RoHS & no Sb/Br)	CU NIPDAU	Level-1-260C-UNLIM	-40 to 85	UY	<a href="#">Samples</a>
TLV717185PDQNR	ACTIVE	X2SON	DQN	4	3000	Green (RoHS & no Sb/Br)	CU NIPDAU	Level-1-260C-UNLIM	-40 to 85	VN	<a href="#">Samples</a>
TLV717185PDQNT	ACTIVE	X2SON	DQN	4	250	Green (RoHS & no Sb/Br)	CU NIPDAU	Level-1-260C-UNLIM	-40 to 85	VN	<a href="#">Samples</a>
TLV71718PDQNR	ACTIVE	X2SON	DQN	4	3000	Green (RoHS & no Sb/Br)	CU NIPDAU	Level-1-260C-UNLIM	-40 to 85	UZ	<a href="#">Samples</a>
TLV71718PDQNT	ACTIVE	X2SON	DQN	4	250	Green (RoHS & no Sb/Br)	CU NIPDAU	Level-1-260C-UNLIM	-40 to 85	UZ	<a href="#">Samples</a>
TLV71721PDQNR	ACTIVE	X2SON	DQN	4	3000	Green (RoHS & no Sb/Br)	CU NIPDAU	Level-1-260C-UNLIM	-40 to 85	AR	<a href="#">Samples</a>
TLV71721PDQNT	ACTIVE	X2SON	DQN	4	250	Green (RoHS & no Sb/Br)	CU NIPDAU	Level-1-260C-UNLIM	-40 to 85	AR	<a href="#">Samples</a>
TLV71725PDQNR	ACTIVE	X2SON	DQN	4	3000	Green (RoHS & no Sb/Br)	CU NIPDAU	Level-1-260C-UNLIM	-40 to 85	VA	<a href="#">Samples</a>
TLV71725PDQNT	ACTIVE	X2SON	DQN	4	250	Green (RoHS & no Sb/Br)	CU NIPDAU	Level-1-260C-UNLIM	-40 to 85	VA	<a href="#">Samples</a>
TLV71727PDQNR	ACTIVE	X2SON	DQN	4	3000	Green (RoHS & no Sb/Br)	CU NIPDAU	Level-1-260C-UNLIM	-40 to 85	AS	<a href="#">Samples</a>
TLV71727PDQNT	ACTIVE	X2SON	DQN	4	250	Green (RoHS & no Sb/Br)	CU NIPDAU	Level-1-260C-UNLIM	-40 to 85	AS	<a href="#">Samples</a>

Orderable Device	Status (1)	Package Type	Package Drawing	Pins	Package Qty	Eco Plan (2)	Lead/Ball Finish	MSL Peak Temp (3)	Op Temp (°C)	Top-Side Markings (4)	Samples
TLV717285PDQNT	ACTIVE	X2SON	DQN	4	250	Green (RoHS & no Sb/Br)	CU NIPDAU	Level-1-260C-UNLIM	-40 to 85	VE	<a href="#">Samples</a>
TLV717285PQNR	PREVIEW	X2SON	DQN	5	3000	TBD	Call TI	Call TI	-40 to 85		
TLV71728PDQNR	ACTIVE	X2SON	DQN	4	3000	Green (RoHS & no Sb/Br)	CU NIPDAU	Level-1-260C-UNLIM	-40 to 85	VD	<a href="#">Samples</a>
TLV71728PDQNR3	ACTIVE	X2SON	DQN	4	3000	Green (RoHS & no Sb/Br)	CU NIPDAU	Level-1-260C-UNLIM	-40 to 85	VD	<a href="#">Samples</a>
TLV71728PDQNT	ACTIVE	X2SON	DQN	4	250	Green (RoHS & no Sb/Br)	CU NIPDAU	Level-1-260C-UNLIM	-40 to 85	VD	<a href="#">Samples</a>
TLV71729PDQNR	ACTIVE	X2SON	DQN	4	3000	Green (RoHS & no Sb/Br)	CU NIPDAU	Level-1-260C-UNLIM	-40 to 85	VI	<a href="#">Samples</a>
TLV71729PDQNT	ACTIVE	X2SON	DQN	4	250	Green (RoHS & no Sb/Br)	CU NIPDAU	Level-1-260C-UNLIM	-40 to 85	VI	<a href="#">Samples</a>
TLV71730PDQNR	ACTIVE	X2SON	DQN	4	3000	Green (RoHS & no Sb/Br)	CU NIPDAU	Level-1-260C-UNLIM	-40 to 85	VF	<a href="#">Samples</a>
TLV71730PDQNT	ACTIVE	X2SON	DQN	4	250	Green (RoHS & no Sb/Br)	CU NIPDAU	Level-1-260C-UNLIM	-40 to 85	VF	<a href="#">Samples</a>
TLV71733PDQNR	ACTIVE	X2SON	DQN	4	3000	Green (RoHS & no Sb/Br)	CU NIPDAU	Level-1-260C-UNLIM	-40 to 85	VG	<a href="#">Samples</a>
TLV71733PDQNT	ACTIVE	X2SON	DQN	4	250	Green (RoHS & no Sb/Br)	CU NIPDAU	Level-1-260C-UNLIM	-40 to 85	VG	<a href="#">Samples</a>
TLV71736PDQNR	ACTIVE	X2SON	DQN	4	3000	Green (RoHS & no Sb/Br)	CU NIPDAU	Level-1-260C-UNLIM	-40 to 85	VH	<a href="#">Samples</a>
TLV71736PDQNT	ACTIVE	X2SON	DQN	4	250	Green (RoHS & no Sb/Br)	CU NIPDAU	Level-1-260C-UNLIM	-40 to 85	VH	<a href="#">Samples</a>

(1) The marketing status values are defined as follows:

**ACTIVE:** Product device recommended for new designs.

**LIFEBUY:** TI has announced that the device will be discontinued, and a lifetime-buy period is in effect.

**NRND:** Not recommended for new designs. Device is in production to support existing customers, but TI does not recommend using this part in a new design.

**PREVIEW:** Device has been announced but is not in production. Samples may or may not be available.

**OBSOLETE:** TI has discontinued the production of the device.

(2) Eco Plan - The planned eco-friendly classification: Pb-Free (RoHS), Pb-Free (RoHS Exempt), or Green (RoHS & no Sb/Br) - please check <http://www.ti.com/productcontent> for the latest availability information and additional product content details.

**TBD:** The Pb-Free/Green conversion plan has not been defined.

**Pb-Free (RoHS):** TI's terms "Lead-Free" or "Pb-Free" mean semiconductor products that are compatible with the current RoHS requirements for all 6 substances, including the requirement that lead not exceed 0.1% by weight in homogeneous materials. Where designed to be soldered at high temperatures, TI Pb-Free products are suitable for use in specified lead-free processes.

---

**Pb-Free (RoHS Exempt):** This component has a RoHS exemption for either 1) lead-based flip-chip solder bumps used between the die and package, or 2) lead-based die adhesive used between the die and leadframe. The component is otherwise considered Pb-Free (RoHS compatible) as defined above.

**Green (RoHS & no Sb/Br):** TI defines "Green" to mean Pb-Free (RoHS compatible), and free of Bromine (Br) and Antimony (Sb) based flame retardants (Br or Sb do not exceed 0.1% by weight in homogeneous material)

<sup>(3)</sup> MSL, Peak Temp. -- The Moisture Sensitivity Level rating according to the JEDEC industry standard classifications, and peak solder temperature.

<sup>(4)</sup> Only one of markings shown within the brackets will appear on the physical device.

**Important Information and Disclaimer:** The information provided on this page represents TI's knowledge and belief as of the date that it is provided. TI bases its knowledge and belief on information provided by third parties, and makes no representation or warranty as to the accuracy of such information. Efforts are underway to better integrate information from third parties. TI has taken and continues to take reasonable steps to provide representative and accurate information but may not have conducted destructive testing or chemical analysis on incoming materials and chemicals. TI and TI suppliers consider certain information to be proprietary, and thus CAS numbers and other limited information may not be available for release.

In no event shall TI's liability arising out of such information exceed the total purchase price of the TI part(s) at issue in this document sold by TI to Customer on an annual basis.

**TAPE AND REEL INFORMATION**

**QUADRANT ASSIGNMENTS FOR PIN 1 ORIENTATION IN TAPE**

\*All dimensions are nominal

Device	Package Type	Package Drawing	Pins	SPQ	Reel Diameter (mm)	Reel Width W1 (mm)	A0 (mm)	B0 (mm)	K0 (mm)	P1 (mm)	W (mm)	Pin1 Quadrant
TLV71712PDQNR	X2SON	DQN	4	3000	180.0	8.4	1.16	1.16	0.63	4.0	8.0	Q2
TLV71712PDQNR	X2SON	DQN	4	3000	180.0	9.5	1.16	1.16	0.63	4.0	8.0	Q2
TLV71712PDQNR3	X2SON	DQN	4	3000	180.0	9.5	1.16	1.16	0.5	2.0	8.0	Q3
TLV71712PDQNT	X2SON	DQN	4	250	180.0	9.5	1.16	1.16	0.63	4.0	8.0	Q2
TLV71712PDQNT	X2SON	DQN	4	250	180.0	8.4	1.16	1.16	0.63	4.0	8.0	Q2
TLV71713PDQNR	X2SON	DQN	4	3000	180.0	9.5	1.16	1.16	0.63	4.0	8.0	Q2
TLV71713PDQNR	X2SON	DQN	4	3000	180.0	8.4	1.16	1.16	0.63	4.0	8.0	Q2
TLV71713PDQNT	X2SON	DQN	4	250	180.0	8.4	1.16	1.16	0.63	4.0	8.0	Q2
TLV71713PDQNT	X2SON	DQN	4	250	180.0	9.5	1.16	1.16	0.63	4.0	8.0	Q2
TLV71715PDQNR	X2SON	DQN	4	3000	180.0	9.5	1.16	1.16	0.63	4.0	8.0	Q2
TLV71715PDQNR	X2SON	DQN	4	3000	180.0	8.4	1.16	1.16	0.63	4.0	8.0	Q2
TLV71715PDQNT	X2SON	DQN	4	250	180.0	8.4	1.16	1.16	0.63	4.0	8.0	Q2
TLV71715PDQNT	X2SON	DQN	4	250	180.0	9.5	1.16	1.16	0.63	4.0	8.0	Q2
TLV717185PDQNR	X2SON	DQN	4	3000	180.0	9.5	1.16	1.16	0.63	4.0	8.0	Q2
TLV717185PDQNR	X2SON	DQN	4	3000	180.0	8.4	1.16	1.16	0.63	4.0	8.0	Q2
TLV717185PDQNT	X2SON	DQN	4	250	180.0	8.4	1.16	1.16	0.63	4.0	8.0	Q2
TLV717185PDQNT	X2SON	DQN	4	250	180.0	9.5	1.16	1.16	0.63	4.0	8.0	Q2
TLV71718PDQNR	X2SON	DQN	4	3000	180.0	8.4	1.16	1.16	0.63	4.0	8.0	Q2

Device	Package Type	Package Drawing	Pins	SPQ	Reel Diameter (mm)	Reel Width W1 (mm)	A0 (mm)	B0 (mm)	K0 (mm)	P1 (mm)	W (mm)	Pin1 Quadrant
TLV71718PDQNR	X2SON	DQN	4	3000	180.0	9.5	1.16	1.16	0.63	4.0	8.0	Q2
TLV71718PDQNT	X2SON	DQN	4	250	180.0	8.4	1.16	1.16	0.63	4.0	8.0	Q2
TLV71718PDQNT	X2SON	DQN	4	250	180.0	9.5	1.16	1.16	0.63	4.0	8.0	Q2
TLV71721PDQNR	X2SON	DQN	4	3000	180.0	9.5	1.16	1.16	0.63	4.0	8.0	Q2
TLV71721PDQNR	X2SON	DQN	4	3000	180.0	8.4	1.16	1.16	0.63	4.0	8.0	Q2
TLV71721PDQNT	X2SON	DQN	4	250	180.0	9.5	1.16	1.16	0.63	4.0	8.0	Q2
TLV71721PDQNT	X2SON	DQN	4	250	180.0	8.4	1.16	1.16	0.63	4.0	8.0	Q2
TLV71725PDQNR	X2SON	DQN	4	3000	180.0	8.4	1.16	1.16	0.63	4.0	8.0	Q2
TLV71725PDQNR	X2SON	DQN	4	3000	180.0	9.5	1.16	1.16	0.63	4.0	8.0	Q2
TLV71725PDQNT	X2SON	DQN	4	250	180.0	8.4	1.16	1.16	0.63	4.0	8.0	Q2
TLV71725PDQNT	X2SON	DQN	4	250	180.0	9.5	1.16	1.16	0.63	4.0	8.0	Q2
TLV71727PDQNR	X2SON	DQN	4	3000	180.0	9.5	1.16	1.16	0.63	4.0	8.0	Q2
TLV71727PDQNR	X2SON	DQN	4	3000	180.0	8.4	1.16	1.16	0.63	4.0	8.0	Q2
TLV71727PDQNT	X2SON	DQN	4	250	180.0	8.4	1.16	1.16	0.63	4.0	8.0	Q2
TLV71727PDQNT	X2SON	DQN	4	250	180.0	9.5	1.16	1.16	0.63	4.0	8.0	Q2
TLV717285PDQNT	X2SON	DQN	4	250	180.0	8.4	1.16	1.16	0.63	4.0	8.0	Q2
TLV717285PDQNT	X2SON	DQN	4	250	180.0	9.5	1.16	1.16	0.63	4.0	8.0	Q2
TLV71728PDQNR	X2SON	DQN	4	3000	180.0	9.5	1.16	1.16	0.63	4.0	8.0	Q2
TLV71728PDQNR	X2SON	DQN	4	3000	180.0	8.4	1.16	1.16	0.63	4.0	8.0	Q2
TLV71728PDQNR3	X2SON	DQN	4	3000	180.0	9.5	1.16	1.16	0.5	2.0	8.0	Q3
TLV71728PDQNT	X2SON	DQN	4	250	180.0	8.4	1.16	1.16	0.63	4.0	8.0	Q2
TLV71728PDQNT	X2SON	DQN	4	250	180.0	9.5	1.16	1.16	0.63	4.0	8.0	Q2
TLV71729PDQNR	X2SON	DQN	4	3000	180.0	8.4	1.16	1.16	0.63	4.0	8.0	Q2
TLV71729PDQNR	X2SON	DQN	4	3000	180.0	9.5	1.16	1.16	0.63	4.0	8.0	Q2
TLV71729PDQNT	X2SON	DQN	4	250	180.0	8.4	1.16	1.16	0.63	4.0	8.0	Q2
TLV71729PDQNT	X2SON	DQN	4	250	180.0	9.5	1.16	1.16	0.63	4.0	8.0	Q2
TLV71730PDQNR	X2SON	DQN	4	3000	180.0	8.4	1.16	1.16	0.63	4.0	8.0	Q2
TLV71730PDQNR	X2SON	DQN	4	3000	180.0	9.5	1.16	1.16	0.63	4.0	8.0	Q2
TLV71730PDQNT	X2SON	DQN	4	250	180.0	9.5	1.16	1.16	0.63	4.0	8.0	Q2
TLV71730PDQNT	X2SON	DQN	4	250	180.0	8.4	1.16	1.16	0.63	4.0	8.0	Q2
TLV71733PDQNR	X2SON	DQN	4	3000	180.0	8.4	1.16	1.16	0.63	4.0	8.0	Q2
TLV71733PDQNR	X2SON	DQN	4	3000	180.0	9.5	1.16	1.16	0.63	4.0	8.0	Q2
TLV71733PDQNT	X2SON	DQN	4	250	180.0	9.5	1.16	1.16	0.63	4.0	8.0	Q2
TLV71733PDQNT	X2SON	DQN	4	250	180.0	8.4	1.16	1.16	0.63	4.0	8.0	Q2
TLV71736PDQNR	X2SON	DQN	4	3000	180.0	8.4	1.16	1.16	0.63	4.0	8.0	Q2
TLV71736PDQNR	X2SON	DQN	4	3000	180.0	9.5	1.16	1.16	0.63	4.0	8.0	Q2
TLV71736PDQNT	X2SON	DQN	4	250	180.0	8.4	1.16	1.16	0.63	4.0	8.0	Q2
TLV71736PDQNT	X2SON	DQN	4	250	180.0	9.5	1.16	1.16	0.63	4.0	8.0	Q2



**TAPE AND REEL BOX DIMENSIONS**



\*All dimensions are nominal

Device	Package Type	Package Drawing	Pins	SPQ	Length (mm)	Width (mm)	Height (mm)
TLV71712PDQNR	X2SON	DQN	4	3000	202.0	201.0	28.0
TLV71712PDQNR	X2SON	DQN	4	3000	180.0	180.0	30.0
TLV71712PDQNR3	X2SON	DQN	4	3000	180.0	180.0	30.0
TLV71712PDQNT	X2SON	DQN	4	250	180.0	180.0	30.0
TLV71712PDQNT	X2SON	DQN	4	250	202.0	201.0	28.0
TLV71713PDQNR	X2SON	DQN	4	3000	180.0	180.0	30.0
TLV71713PDQNR	X2SON	DQN	4	3000	202.0	201.0	28.0
TLV71713PDQNT	X2SON	DQN	4	250	202.0	201.0	28.0
TLV71713PDQNT	X2SON	DQN	4	250	180.0	180.0	30.0
TLV71715PDQNR	X2SON	DQN	4	3000	180.0	180.0	30.0
TLV71715PDQNR	X2SON	DQN	4	3000	202.0	201.0	28.0
TLV71715PDQNT	X2SON	DQN	4	250	202.0	201.0	28.0
TLV71715PDQNT	X2SON	DQN	4	250	180.0	180.0	30.0
TLV717185PDQNR	X2SON	DQN	4	3000	180.0	180.0	30.0
TLV717185PDQNR	X2SON	DQN	4	3000	202.0	201.0	28.0
TLV717185PDQNT	X2SON	DQN	4	250	202.0	201.0	28.0
TLV717185PDQNT	X2SON	DQN	4	250	180.0	180.0	30.0
TLV71718PDQNR	X2SON	DQN	4	3000	202.0	201.0	28.0
TLV71718PDQNR	X2SON	DQN	4	3000	180.0	180.0	30.0
TLV71718PDQNT	X2SON	DQN	4	250	202.0	201.0	28.0

Device	Package Type	Package Drawing	Pins	SPQ	Length (mm)	Width (mm)	Height (mm)
TLV71718PDQNT	X2SON	DQN	4	250	180.0	180.0	30.0
TLV71721PDQNR	X2SON	DQN	4	3000	180.0	180.0	30.0
TLV71721PDQNR	X2SON	DQN	4	3000	202.0	201.0	28.0
TLV71721PDQNT	X2SON	DQN	4	250	180.0	180.0	30.0
TLV71721PDQNT	X2SON	DQN	4	250	202.0	201.0	28.0
TLV71725PDQNR	X2SON	DQN	4	3000	202.0	201.0	28.0
TLV71725PDQNR	X2SON	DQN	4	3000	180.0	180.0	30.0
TLV71725PDQNT	X2SON	DQN	4	250	202.0	201.0	28.0
TLV71725PDQNT	X2SON	DQN	4	250	180.0	180.0	30.0
TLV71727PDQNR	X2SON	DQN	4	3000	180.0	180.0	30.0
TLV71727PDQNR	X2SON	DQN	4	3000	202.0	201.0	28.0
TLV71727PDQNT	X2SON	DQN	4	250	202.0	201.0	28.0
TLV71727PDQNT	X2SON	DQN	4	250	180.0	180.0	30.0
TLV717285PDQNT	X2SON	DQN	4	250	202.0	201.0	28.0
TLV717285PDQNT	X2SON	DQN	4	250	180.0	180.0	30.0
TLV71728PDQNR	X2SON	DQN	4	3000	180.0	180.0	30.0
TLV71728PDQNR	X2SON	DQN	4	3000	202.0	201.0	28.0
TLV71728PDQNR3	X2SON	DQN	4	3000	180.0	180.0	30.0
TLV71728PDQNT	X2SON	DQN	4	250	202.0	201.0	28.0
TLV71728PDQNT	X2SON	DQN	4	250	180.0	180.0	30.0
TLV71729PDQNR	X2SON	DQN	4	3000	202.0	201.0	28.0
TLV71729PDQNR	X2SON	DQN	4	3000	180.0	180.0	30.0
TLV71729PDQNT	X2SON	DQN	4	250	202.0	201.0	28.0
TLV71729PDQNT	X2SON	DQN	4	250	180.0	180.0	30.0
TLV71730PDQNR	X2SON	DQN	4	3000	202.0	201.0	28.0
TLV71730PDQNR	X2SON	DQN	4	3000	180.0	180.0	30.0
TLV71730PDQNT	X2SON	DQN	4	250	180.0	180.0	30.0
TLV71730PDQNT	X2SON	DQN	4	250	202.0	201.0	28.0
TLV71733PDQNR	X2SON	DQN	4	3000	202.0	201.0	28.0
TLV71733PDQNR	X2SON	DQN	4	3000	180.0	180.0	30.0
TLV71733PDQNT	X2SON	DQN	4	250	180.0	180.0	30.0
TLV71733PDQNT	X2SON	DQN	4	250	202.0	201.0	28.0
TLV71736PDQNR	X2SON	DQN	4	3000	202.0	201.0	28.0
TLV71736PDQNR	X2SON	DQN	4	3000	180.0	180.0	30.0
TLV71736PDQNT	X2SON	DQN	4	250	202.0	201.0	28.0
TLV71736PDQNT	X2SON	DQN	4	250	180.0	180.0	30.0

DQN (S-PX2SON-N4)

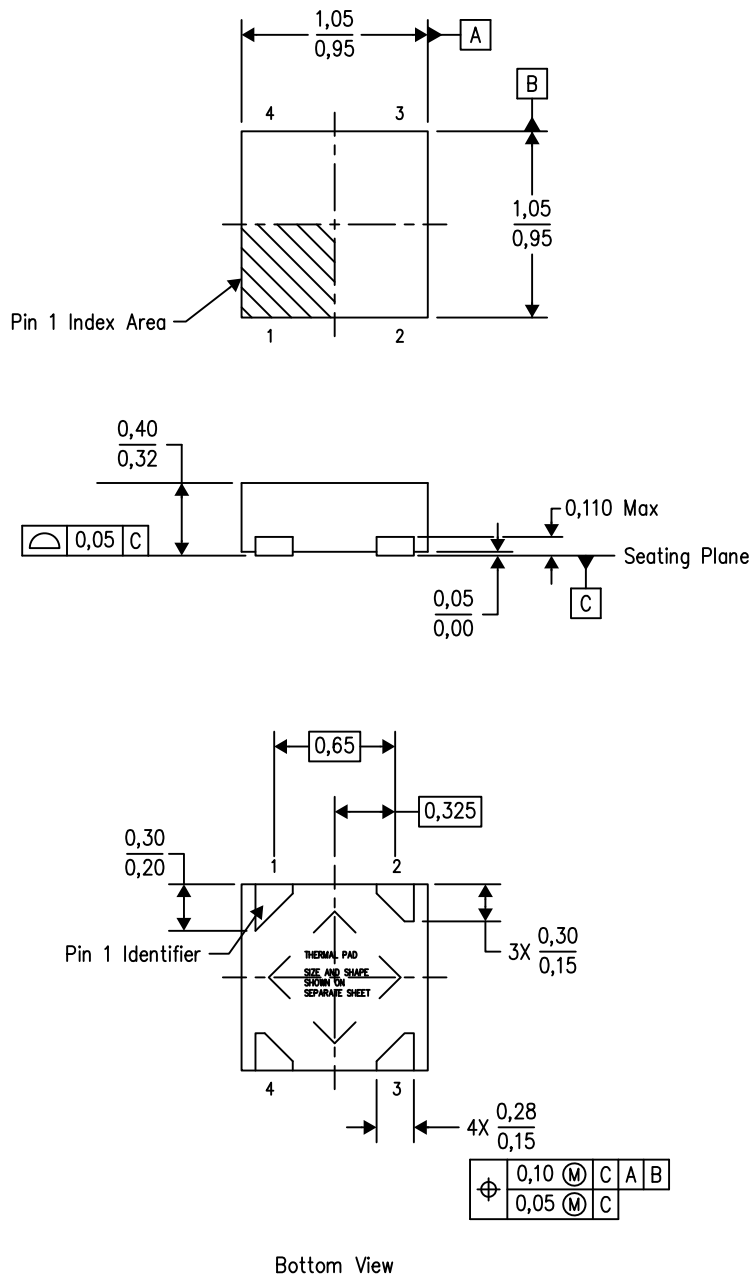
PLASTIC SMALL OUTLINE NO-LEAD



4210367/D 09/2012

- NOTES:
- All linear dimensions are in millimeters. Dimensioning and tolerancing per ASME Y14.5M-1994.
  - This drawing is subject to change without notice.
  - SON (Small Outline No-Lead) package configuration.
  - The package thermal pad must be soldered to the board for thermal and mechanical performance.
  - See the additional figure in the Product Data Sheet for details regarding the exposed thermal pad features and dimensions.

## THERMAL PAD MECHANICAL DATA

DQN (S-PX2SON-N4)

PLASTIC SMALL OUTLINE NO-LEAD

### THERMAL INFORMATION

This package incorporates an exposed thermal pad that is designed to be attached directly to an external heatsink. The thermal pad must be soldered directly to the printed circuit board (PCB). After soldering, the PCB can be used as a heatsink. In addition, through the use of thermal vias, the thermal pad can be attached directly to the appropriate copper plane shown in the electrical schematic for the device, or alternatively, can be attached to a special heatsink structure designed into the PCB. This design optimizes the heat transfer from the integrated circuit (IC).

For information on the Quad Flatpack No-Lead (QFN) package and its advantages, refer to Application Report, QFN/SON PCB Attachment, Texas Instruments Literature No. SLUA271. This document is available at [www.ti.com](http://www.ti.com).

The exposed thermal pad dimensions for this package are shown in the following illustration.

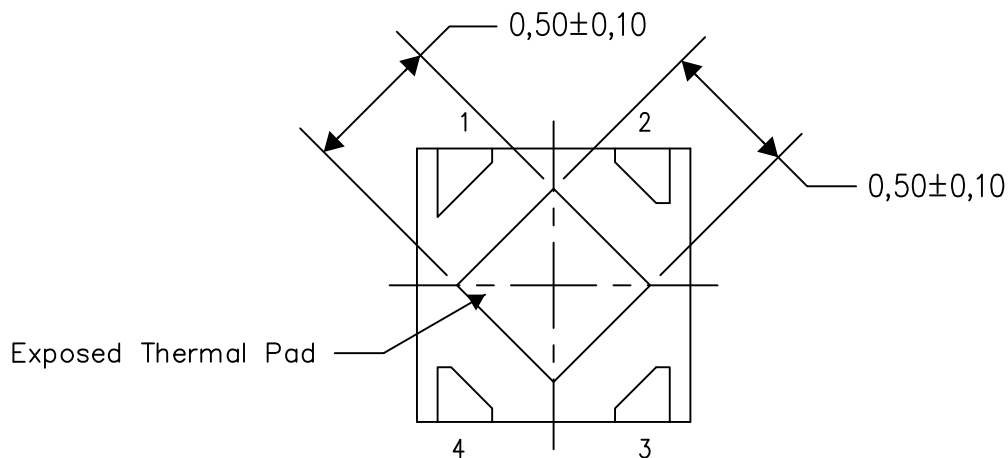

Bottom View

Exposed Thermal Pad Dimensions

4210393-2/E 04/12

NOTE: All linear dimensions are in millimeters

DQN (S-PX2SON-N4)

PLASTIC SMALL OUTLINE NO-LEAD

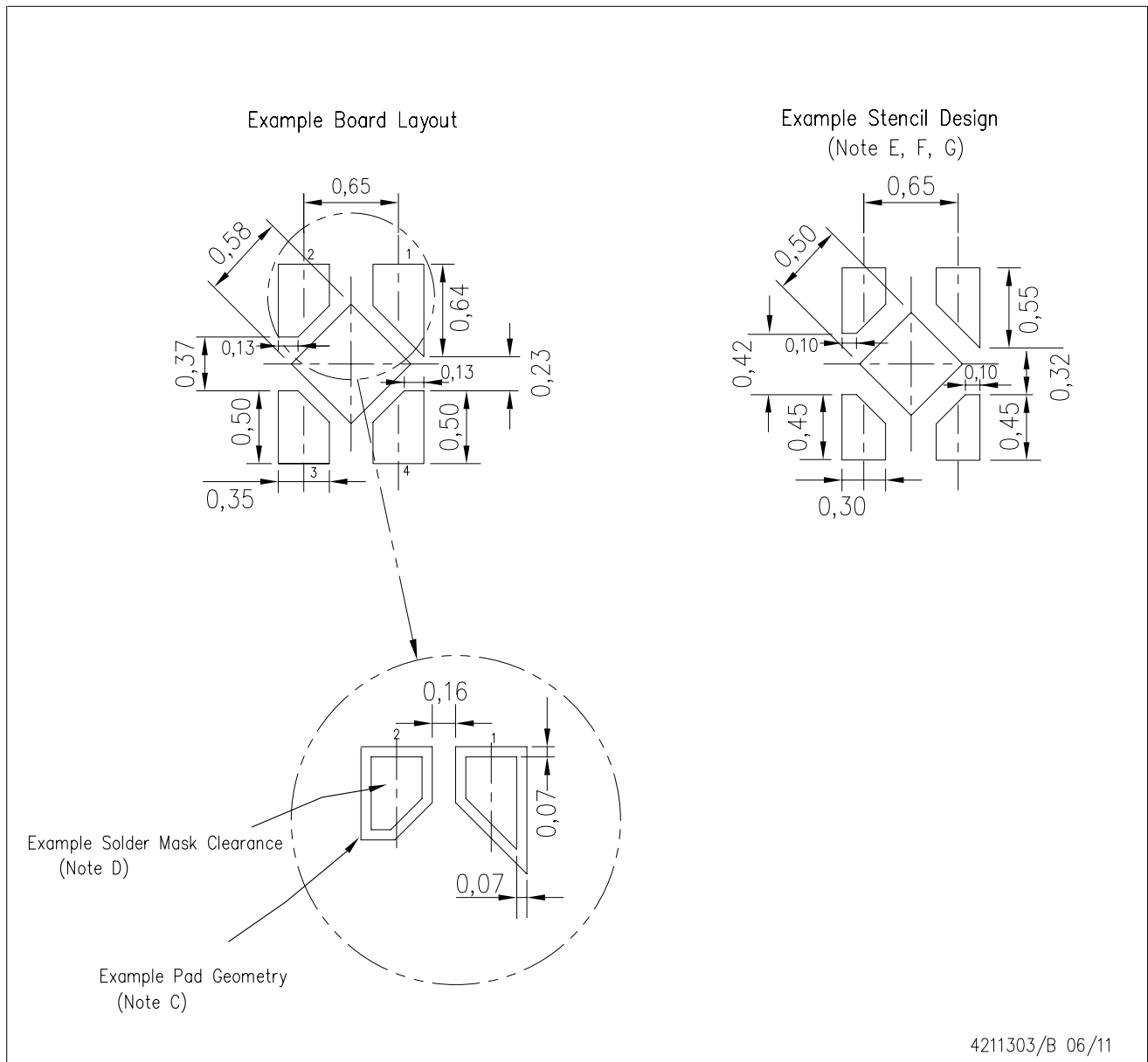

- NOTES:
- All linear dimensions are in millimeters.
  - This drawing is subject to change without notice.
  - Publication IPC-7351 is recommended for alternate designs.
  - Customers should contact their board fabrication site for minimum solder mask web tolerances between signal pads.
  - Maximum stencil thickness 0,127 mm (5 mils). All linear dimensions are in millimeters.
  - Laser cutting apertures with trapezoidal walls and also rounding corners will offer better paste release. Customers should contact their board assembly site for stencil design recommendations. Refer to IPC 7525 for stencil design considerations.
  - Side aperture dimensions over-print land for acceptable area ratio > 0.66. Customer may reduce side aperture dimensions if stencil manufacturing process allows for sufficient release at smaller opening.

## THERMAL PAD MECHANICAL DATA

DQN (S-PX2SON-N4)

PLASTIC SMALL OUTLINE NO-LEAD

### THERMAL INFORMATION

This package incorporates an exposed thermal pad that is designed to be attached directly to an external heatsink. The thermal pad must be soldered directly to the printed circuit board (PCB). After soldering, the PCB can be used as a heatsink. In addition, through the use of thermal vias, the thermal pad can be attached directly to the appropriate copper plane shown in the electrical schematic for the device, or alternatively, can be attached to a special heatsink structure designed into the PCB. This design optimizes the heat transfer from the integrated circuit (IC).

For information on the Quad Flatpack No-Lead (QFN) package and its advantages, refer to Application Report, QFN/SON PCB Attachment, Texas Instruments Literature No. SLUA271. This document is available at [www.ti.com](http://www.ti.com).

The exposed thermal pad dimensions for this package are shown in the following illustration.

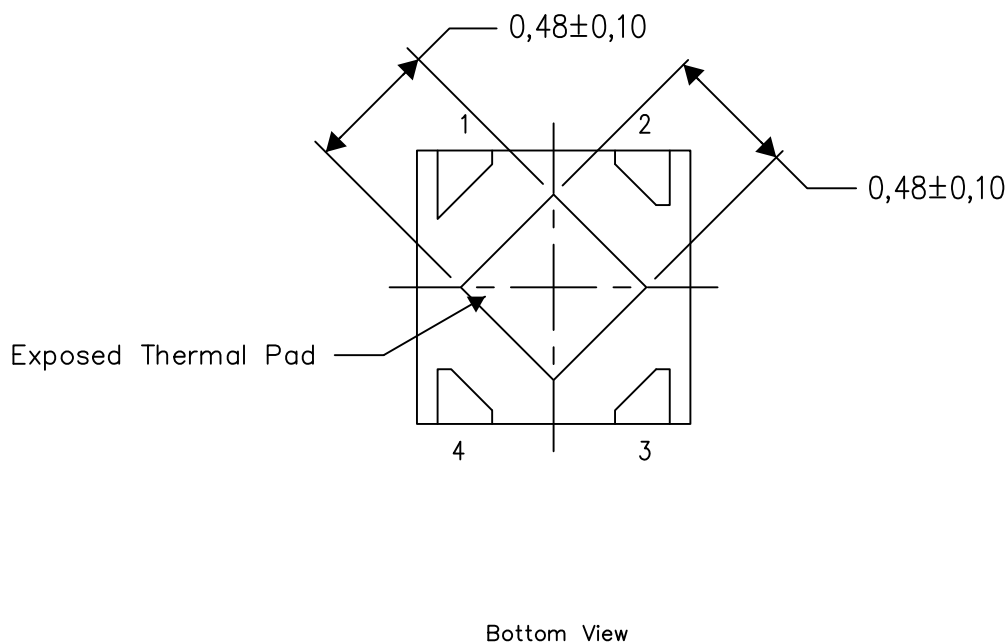

Exposed Thermal Pad Dimensions

4210393-3/E 04/12

NOTE: All linear dimensions are in millimeters

## IMPORTANT NOTICE

Texas Instruments Incorporated and its subsidiaries (TI) reserve the right to make corrections, enhancements, improvements and other changes to its semiconductor products and services per JESD46, latest issue, and to discontinue any product or service per JESD48, latest issue. Buyers should obtain the latest relevant information before placing orders and should verify that such information is current and complete. All semiconductor products (also referred to herein as "components") are sold subject to TI's terms and conditions of sale supplied at the time of order acknowledgment.

TI warrants performance of its components to the specifications applicable at the time of sale, in accordance with the warranty in TI's terms and conditions of sale of semiconductor products. Testing and other quality control techniques are used to the extent TI deems necessary to support this warranty. Except where mandated by applicable law, testing of all parameters of each component is not necessarily performed.

TI assumes no liability for applications assistance or the design of Buyers' products. Buyers are responsible for their products and applications using TI components. To minimize the risks associated with Buyers' products and applications, Buyers should provide adequate design and operating safeguards.

TI does not warrant or represent that any license, either express or implied, is granted under any patent right, copyright, mask work right, or other intellectual property right relating to any combination, machine, or process in which TI components or services are used. Information published by TI regarding third-party products or services does not constitute a license to use such products or services or a warranty or endorsement thereof. Use of such information may require a license from a third party under the patents or other intellectual property of the third party, or a license from TI under the patents or other intellectual property of TI.

Reproduction of significant portions of TI information in TI data books or data sheets is permissible only if reproduction is without alteration and is accompanied by all associated warranties, conditions, limitations, and notices. TI is not responsible or liable for such altered documentation. Information of third parties may be subject to additional restrictions.

Resale of TI components or services with statements different from or beyond the parameters stated by TI for that component or service voids all express and any implied warranties for the associated TI component or service and is an unfair and deceptive business practice. TI is not responsible or liable for any such statements.

Buyer acknowledges and agrees that it is solely responsible for compliance with all legal, regulatory and safety-related requirements concerning its products, and any use of TI components in its applications, notwithstanding any applications-related information or support that may be provided by TI. Buyer represents and agrees that it has all the necessary expertise to create and implement safeguards which anticipate dangerous consequences of failures, monitor failures and their consequences, lessen the likelihood of failures that might cause harm and take appropriate remedial actions. Buyer will fully indemnify TI and its representatives against any damages arising out of the use of any TI components in safety-critical applications.

In some cases, TI components may be promoted specifically to facilitate safety-related applications. With such components, TI's goal is to help enable customers to design and create their own end-product solutions that meet applicable functional safety standards and requirements. Nonetheless, such components are subject to these terms.

No TI components are authorized for use in FDA Class III (or similar life-critical medical equipment) unless authorized officers of the parties have executed a special agreement specifically governing such use.

Only those TI components which TI has specifically designated as military grade or "enhanced plastic" are designed and intended for use in military/aerospace applications or environments. Buyer acknowledges and agrees that any military or aerospace use of TI components which have **not** been so designated is solely at the Buyer's risk, and that Buyer is solely responsible for compliance with all legal and regulatory requirements in connection with such use.

TI has specifically designated certain components as meeting ISO/TS16949 requirements, mainly for automotive use. In any case of use of non-designated products, TI will not be responsible for any failure to meet ISO/TS16949.

### Products

Audio	<a href="http://www.ti.com/audio">www.ti.com/audio</a>
Amplifiers	<a href="http://amplifier.ti.com">amplifier.ti.com</a>
Data Converters	<a href="http://dataconverter.ti.com">dataconverter.ti.com</a>
DLP® Products	<a href="http://www.dlp.com">www.dlp.com</a>
DSP	<a href="http://dsp.ti.com">dsp.ti.com</a>
Clocks and Timers	<a href="http://www.ti.com/clocks">www.ti.com/clocks</a>
Interface	<a href="http://interface.ti.com">interface.ti.com</a>
Logic	<a href="http://logic.ti.com">logic.ti.com</a>
Power Mgmt	<a href="http://power.ti.com">power.ti.com</a>
Microcontrollers	<a href="http://microcontroller.ti.com">microcontroller.ti.com</a>
RFID	<a href="http://www.ti-rfid.com">www.ti-rfid.com</a>
OMAP Applications Processors	<a href="http://www.ti.com/omap">www.ti.com/omap</a>
Wireless Connectivity	<a href="http://www.ti.com/wirelessconnectivity">www.ti.com/wirelessconnectivity</a>

### Applications

Automotive and Transportation	<a href="http://www.ti.com/automotive">www.ti.com/automotive</a>
Communications and Telecom	<a href="http://www.ti.com/communications">www.ti.com/communications</a>
Computers and Peripherals	<a href="http://www.ti.com/computers">www.ti.com/computers</a>
Consumer Electronics	<a href="http://www.ti.com/consumer-apps">www.ti.com/consumer-apps</a>
Energy and Lighting	<a href="http://www.ti.com/energy">www.ti.com/energy</a>
Industrial	<a href="http://www.ti.com/industrial">www.ti.com/industrial</a>
Medical	<a href="http://www.ti.com/medical">www.ti.com/medical</a>
Security	<a href="http://www.ti.com/security">www.ti.com/security</a>
Space, Avionics and Defense	<a href="http://www.ti.com/space-avionics-defense">www.ti.com/space-avionics-defense</a>
Video and Imaging	<a href="http://www.ti.com/video">www.ti.com/video</a>

### TI E2E Community

[e2e.ti.com](http://e2e.ti.com)