

## RAIL-TO-RAIL OUTPUT, VERY LOW-NOISE OPERATIONAL AMPLIFIERS

 Check for Samples: [TL971-Q1](#), [TL972-Q1](#), [TL974-Q1](#)

### FEATURES

- Qualified for Automotive Applications
- Rail-to-Rail Output Voltage Swing:  
 $\pm 2.4\text{ V}$  at  $V_{CC} = \pm 2.5\text{ V}$
- Very Low Noise Level:  $4\text{ nV}/\sqrt{\text{Hz}}$
- Ultra-Low Distortion: 0.003%
- High Dynamic Features: 12 MHz, 5 V/ $\mu\text{s}$
- Operating Range: 2.7 V to 12 V
- Latch-Up Performance Exceeds 100 mA Per JESD 78, Class II
- ESD Performance Tested Per JESD 22
  - 2000-V Human-Body Model (A114-B)
  - 200-V Machine Model (A115-A)
  - 1500-V Charged-Device Model (C101)

### APPLICATIONS

- Portable Equipment (CD Players, PDAs)
- Portable Communications (Cell Phones, Pagers)
- Instrumentation and Sensors
- Professional Audio Circuits

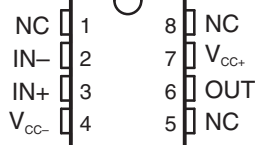
**TL971...D PACKAGE  
(TOP VIEW)**

NC – No internal connection

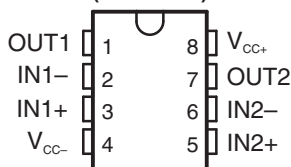
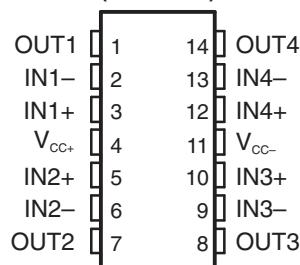
**TL972...D OR PW PACKAGE  
(TOP VIEW)**

**TL974...PW PACKAGE  
(TOP VIEW)**

### DESCRIPTION/ORDERING INFORMATION

The TL97x family of operational amplifiers operates at voltages as low as  $\pm 1.35\text{ V}$  and features output rail-to-rail signal swing. The TL97x boast characteristics that make them particularly well suited for portable and battery-supplied equipment. Very low noise and low distortion characteristics make them ideal for audio preamplification.

#### ORDERING INFORMATION<sup>(1)(2)</sup>

$T_A$	ORDERABLE PART NUMBER	TOP-SIDE MARKING
–40°C to 125°C	TL971QDRQ1	TL971Q
	TL972QDRQ1	TL972Q
	TL972QPWRQ1	TL972Q
	TL974QPWRQ1	TL974Q

- (1) For the most current package and ordering information, see the Package Option Addendum at the end of this document, or see the TI web site at [www.ti.com](http://www.ti.com).
- (2) Package drawings, thermal data, and symbolization are available at [www.ti.com/packaging](http://www.ti.com/packaging).



Please be aware that an important notice concerning availability, standard warranty, and use in critical applications of Texas Instruments semiconductor products and disclaimers thereto appears at the end of this data sheet.

## ABSOLUTE MAXIMUM RATINGS<sup>(1)</sup>

over operating free-air temperature range (unless otherwise noted)

$V_{CC}$	Supply voltage range <sup>(2)</sup>			2.7 V to 15 V
$V_{ID}$	Differential input voltage <sup>(3)</sup>			±1 V
$V_{IN}$	Input voltage range <sup>(4)</sup>			$V_{CC-} - 0.3 \text{ V}$ to $V_{CC+} + 0.3 \text{ V}$
$\theta_{JA}$	Package thermal impedance, junction to free air	D package <sup>(5)</sup>	8 pin	97°C/W
		PW package <sup>(5)</sup>	8 pin	149°C/W
			14 pin	113°C/W
$T_J$	Maximum junction temperature			150°C
$T_{lead}$	Maximum lead temperature	Soldering, 10 seconds		260°C
$T_{stg}$	Storage temperature range			-65°C to 150°C
ESD	Electrostatic discharge protection	Human-Body Model (HBM)		2000 V
		Machine Model (MM)		200 V
		Charged-Device Model (CDM)		1500 V

- (1) Stresses beyond those listed under "absolute maximum ratings" may cause permanent damage to the device. These are stress ratings only, and functional operation of the device at these or any other conditions beyond those indicated under "recommended operating conditions" is not implied. Exposure to absolute-maximum-rated conditions for extended periods may affect device reliability.
- (2) All voltage values, except differential voltages, are with respect to network ground terminal.
- (3) Differential voltages for the noninverting input terminal are with respect to the inverting input terminal.
- (4) The input and output voltages must never exceed  $V_{CC} + 0.3 \text{ V}$ .
- (5) Package thermal impedance is calculated in accordance with JESD 51-7.

## RECOMMENDED OPERATING CONDITIONS

		MIN	MAX	UNIT
$V_{CC}$	Supply voltage	2.7	12	V
$V_{ICM}$	Common-mode input voltage	$V_{CC-} + 1.15$	$V_{CC+} - 1.15$	V
$T_A$	Operating free-air temperature	-40	125	°C

## ELECTRICAL CHARACTERISTICS

 $V_{CC+} = 2.5\text{ V}$ ,  $V_{CC-} = -2.5\text{ V}$  (unless otherwise noted)

PARAMETER		TEST CONDITIONS	$T_A$ <sup>(1)</sup>	MIN	TYP	MAX	UNIT
$V_{IO}$	Input offset voltage		25°C		1	4	mV
			Full range			6	
$\alpha V_{IO}$	Input offset voltage drift	$V_{ICM} = 0\text{ V}$ , $V_O = 0\text{ V}$	25°C		5		$\mu\text{V}/^\circ\text{C}$
$I_{IO}$	Input offset current	$V_{ICM} = 0\text{ V}$ , $V_O = 0\text{ V}$	25°C		10	150	nA
$I_{IB}$	Input bias current	$V_{ICM} = 0\text{ V}$ , $V_O = 0\text{ V}$	25°C		200	750	nA
			Full range			1000	
$V_{ICM}$	Common-mode input voltage		25°C	-1.35		1.35	V
CMRR	Common-mode rejection ratio	$V_{ICM} = \pm 1.35\text{ V}$	25°C	60	85		dB
SVR	Supply-voltage rejection ratio	$V_{CC} = \pm 2\text{ V}$ to $\pm 3\text{ V}$	25°C	60	70		dB
$A_{VD}$	Large-signal voltage gain	$R_L = 2\text{ k}\Omega$	25°C	70	80		dB
$V_{OH}$	High-level output voltage	$R_L = 2\text{ k}\Omega$	25°C	2	2.4		V
$V_{OL}$	Low-level output voltage	$R_L = 2\text{ k}\Omega$	25°C		-2.4	-2	V
$I_{source}$	Output source current	$V_{OUT}$ shorted to -2.5 V	25°C	1.2	1.4		mA
			Full range		1		
$I_{sink}$	Output sink current	$V_{OUT}$ shorted to +2.5 V	25°C	50	80		mA
			Full range		25		
$I_{CC}$	Supply current (per amplifier)	Unity gain, No load	25°C		2	2.8	mA
			Full range			3.2	
GBWP	Gain bandwidth product	$f = 100\text{ kHz}$ , $R_L = 2\text{ k}\Omega$ , $C_L = 100\text{ pF}$	25°C	8.5	12		MHz
SR	Slew rate	$A_V = 1$ , $V_{IN} = \pm 1\text{ V}$	25°C	3.5	5		V/ $\mu\text{s}$
			Full range		3		
$\Phi_m$	Phase margin at unity gain	$R_L = 2\text{ k}\Omega$ , $C_L = 100\text{ pF}$	25°C		60		°
Gm	Gain margin	$R_L = 2\text{ k}\Omega$ , $C_L = 100\text{ pF}$	25°C		10		dB
$V_n$	Equivalent input noise voltage	$f = 100\text{ kHz}$	25°C		4		$\text{nV}/\sqrt{\text{Hz}}$
THD	Total harmonic distortion	$f = 1\text{ kHz}$ , $A_V = -1$ , $R_L = 10\text{ k}\Omega$	25°C		0.003		%

 (1) Full range  $T_A = -40^\circ\text{C}$  to  $125^\circ\text{C}$

TYPICAL CHARACTERISTICS

GAIN AND PHASE  
 vs  
 FREQUENCY

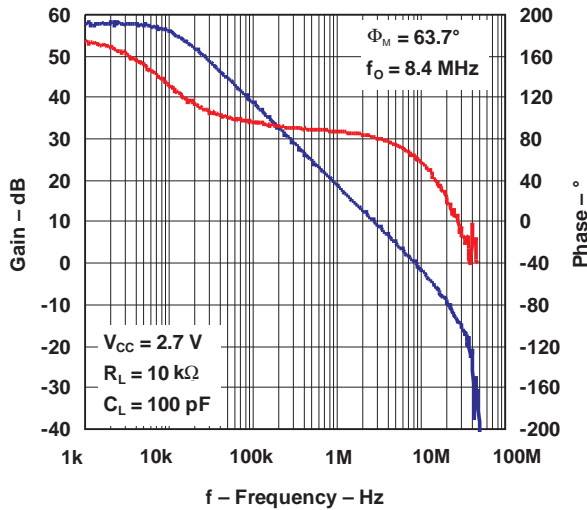

GAIN AND PHASE  
 vs  
 FREQUENCY

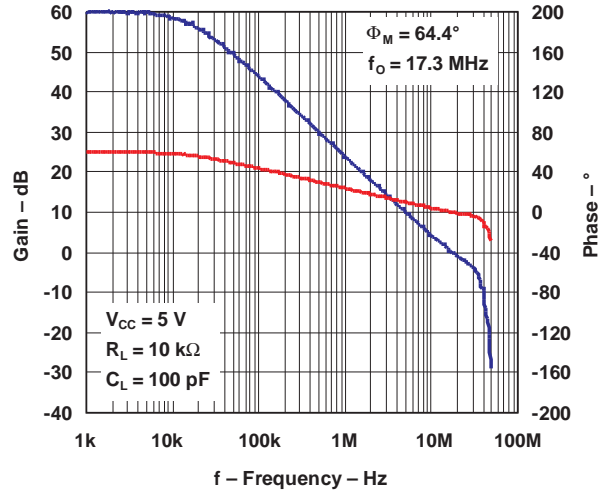

TOTAL HARMONIC DISTORTION  
 vs  
 FREQUENCY

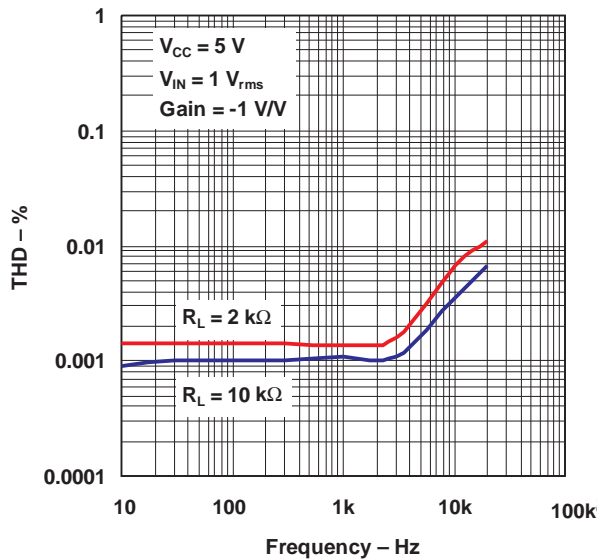

TOTAL HARMONIC DISTORTION + NOISE  
 vs  
 OUTPUT VOLTAGE

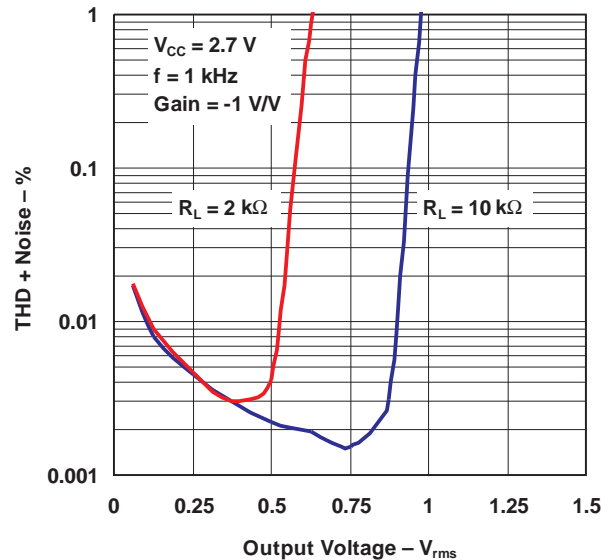

**TYPICAL CHARACTERISTICS (continued)**

**TOTAL HARMONIC DISTORTION + NOISE**  
vs  
**OUTPUT VOLTAGE**

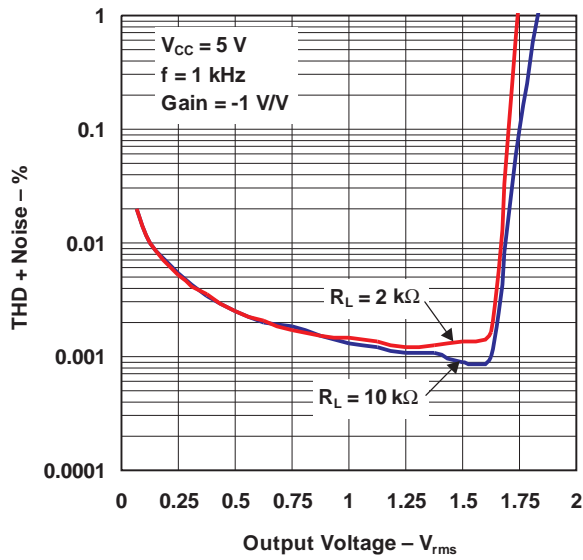

**INPUT VOLTAGE NOISE**  
vs  
**FREQUENCY**

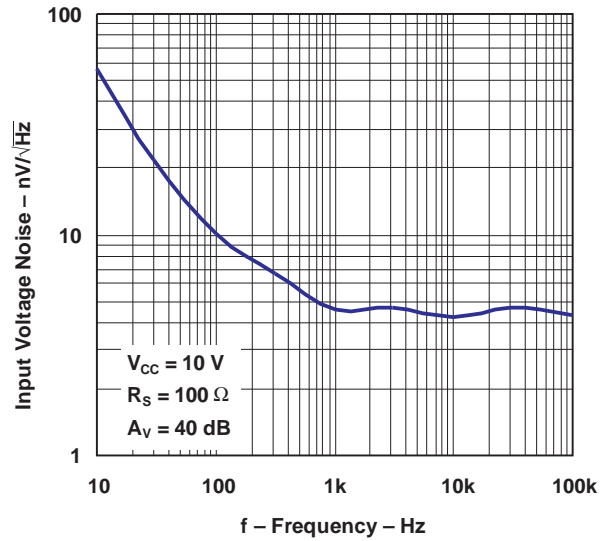

**GAIN BANDWIDTH PRODUCT**  
vs  
**OUTPUT CURRENT**

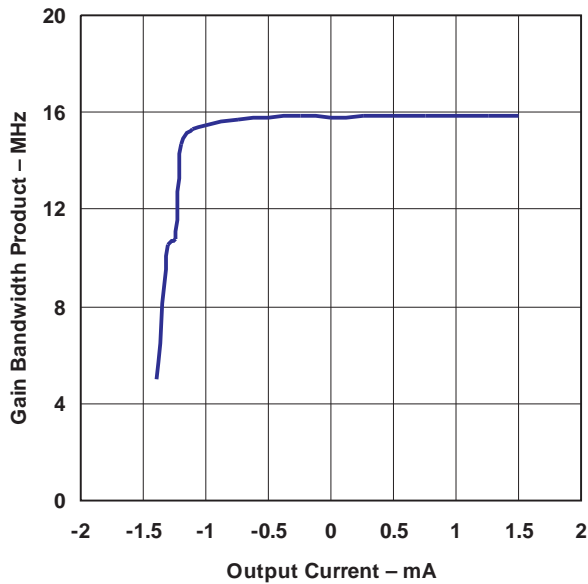

**GAIN BANDWIDTH PRODUCT**  
vs  
**SUPPLY VOLTAGE**

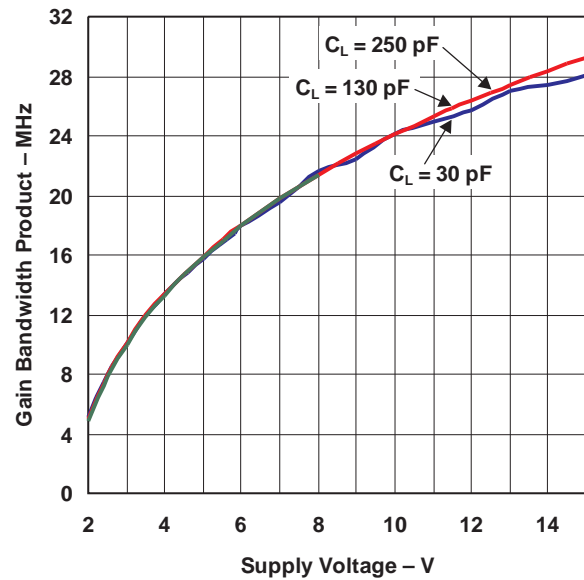

**TYPICAL CHARACTERISTICS (continued)**

**PHASE MARGIN  
 vs  
 OUTPUT CURRENT**

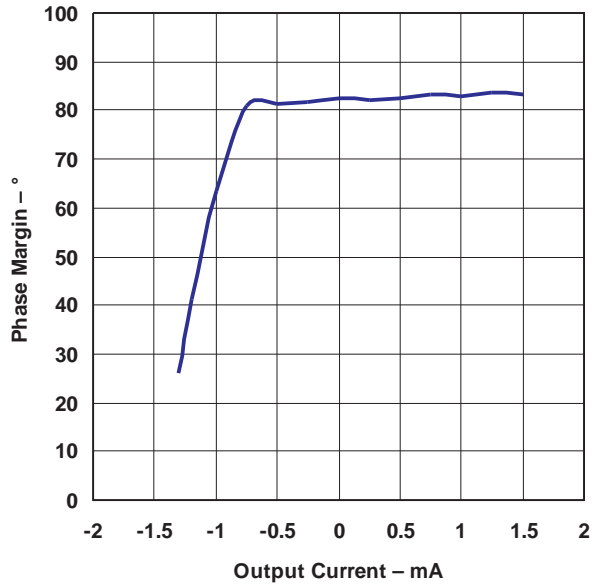

**PHASE MARGIN  
 vs  
 SUPPLY VOLTAGE**

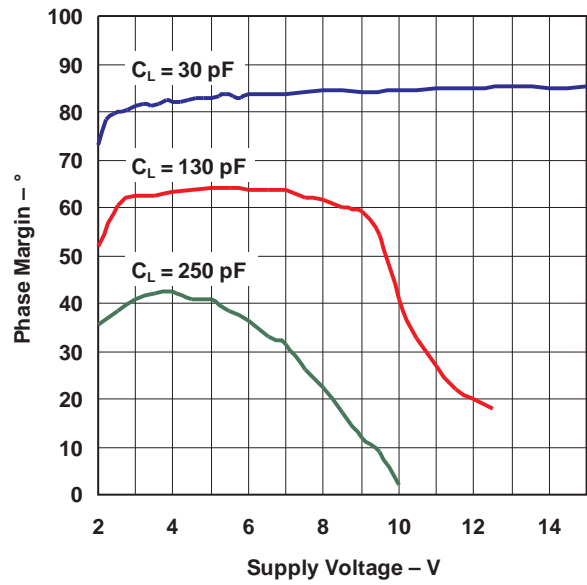

**GAIN MARGIN  
 vs  
 SUPPLY VOLTAGE**

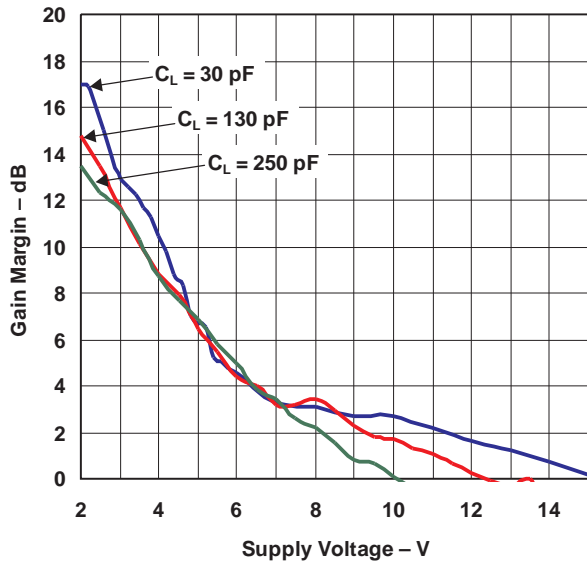

**INPUT RESPONSE**

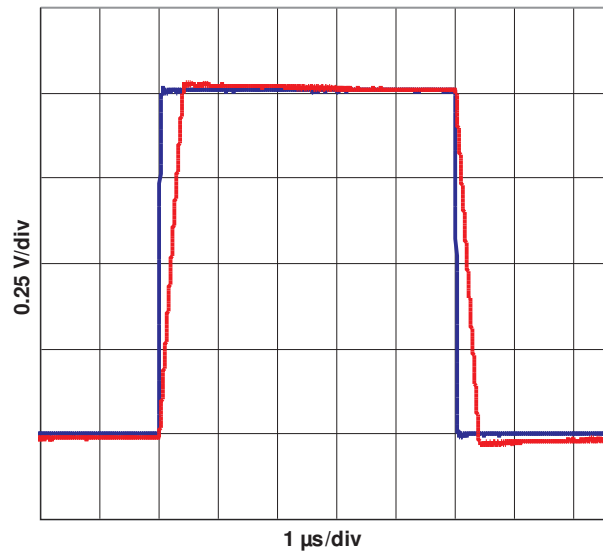

TYPICAL CHARACTERISTICS (continued)

POWER-SUPPLY RIPPLE REJECTION  
vs  
FREQUENCY

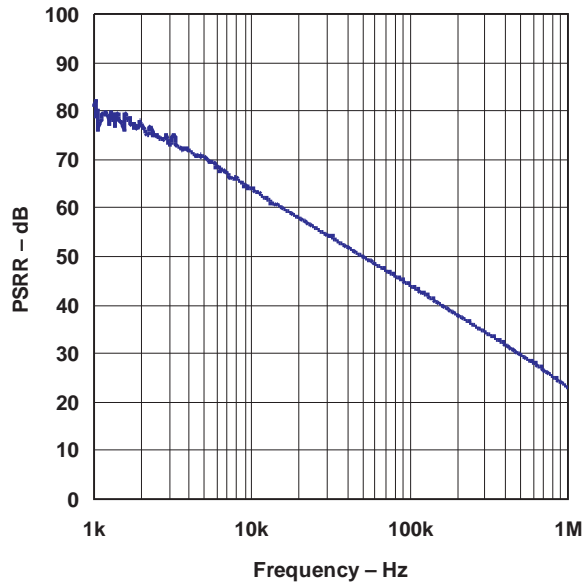

OUTPUT VOLTAGE  
vs  
OUTPUT CURRENT

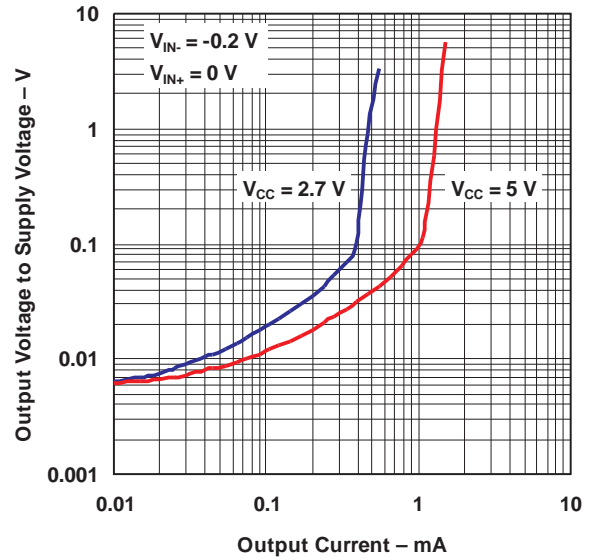

OUTPUT IMPEDANCE  
vs  
FREQUENCY

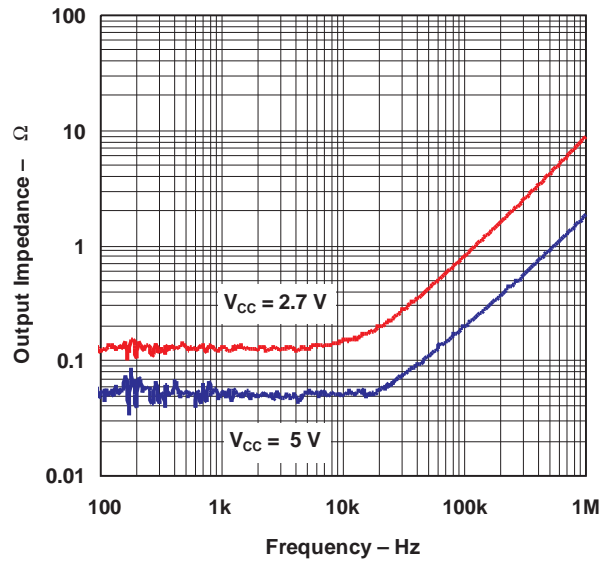

SLEW RATE  
vs  
SUPPLY VOLTAGE

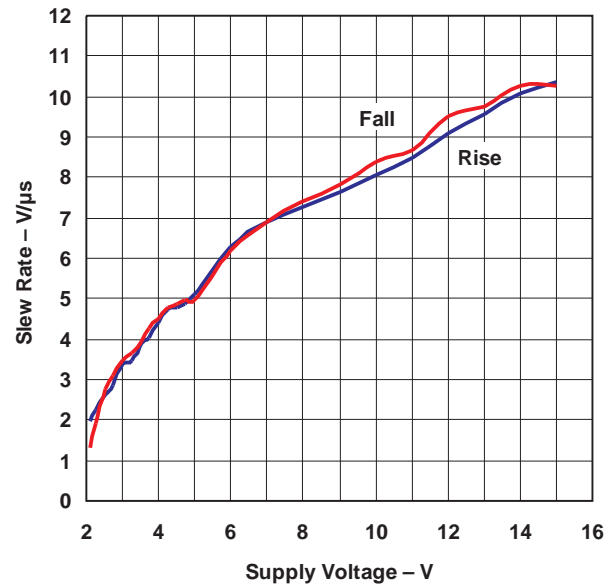

## REVISION HISTORY

Changes from Original (March 2009) to Revision A	Page
• Removed packaging column from the ordering information table. ....	1
• Changed $V_{OUT} = \pm 2.5\text{ V}$ to $V_{OUT}$ shorted to $-2.5\text{ V}$ for $I_{SOURCE}$ , and changed $V_{OUT} = \pm 2.5\text{ V}$ to $V_{OUT}$ shorted to $+2.5\text{ V}$ for $I_{SINK}$ . ....	3



**PACKAGING INFORMATION**

Orderable Device	Status <sup>(1)</sup>	Package Type	Package Drawing	Pins	Package Qty	Eco Plan <sup>(2)</sup>	Lead/ Ball Finish	MSL Peak Temp <sup>(3)</sup>	Samples (Requires Login)
TL971QDRQ1	ACTIVE	SOIC	D	8	2500	Green (RoHS & no Sb/Br)	CU NIPDAU	Level-1-260C-UNLIM	
TL972QDRQ1	ACTIVE	SOIC	D	8	2500	Green (RoHS & no Sb/Br)	CU NIPDAU	Level-1-260C-UNLIM	
TL972QPWRQ1	ACTIVE	TSSOP	PW	8	2000	Green (RoHS & no Sb/Br)	CU NIPDAU	Level-1-260C-UNLIM	
TL974QPWRQ1	ACTIVE	TSSOP	PW	14	2000	Green (RoHS & no Sb/Br)	CU NIPDAU	Level-1-260C-UNLIM	

<sup>(1)</sup> The marketing status values are defined as follows:

**ACTIVE:** Product device recommended for new designs.

**LIFEBUY:** TI has announced that the device will be discontinued, and a lifetime-buy period is in effect.

**NRND:** Not recommended for new designs. Device is in production to support existing customers, but TI does not recommend using this part in a new design.

**PREVIEW:** Device has been announced but is not in production. Samples may or may not be available.

**OBSELETE:** TI has discontinued the production of the device.

<sup>(2)</sup> Eco Plan - The planned eco-friendly classification: Pb-Free (RoHS), Pb-Free (RoHS Exempt), or Green (RoHS & no Sb/Br) - please check <http://www.ti.com/productcontent> for the latest availability information and additional product content details.

**TBD:** The Pb-Free/Green conversion plan has not been defined.

**Pb-Free (RoHS):** TI's terms "Lead-Free" or "Pb-Free" mean semiconductor products that are compatible with the current RoHS requirements for all 6 substances, including the requirement that lead not exceed 0.1% by weight in homogeneous materials. Where designed to be soldered at high temperatures, TI Pb-Free products are suitable for use in specified lead-free processes.

**Pb-Free (RoHS Exempt):** This component has a RoHS exemption for either 1) lead-based flip-chip solder bumps used between the die and package, or 2) lead-based die adhesive used between the die and leadframe. The component is otherwise considered Pb-Free (RoHS compatible) as defined above.

**Green (RoHS & no Sb/Br):** TI defines "Green" to mean Pb-Free (RoHS compatible), and free of Bromine (Br) and Antimony (Sb) based flame retardants (Br or Sb do not exceed 0.1% by weight in homogeneous material)

<sup>(3)</sup> MSL, Peak Temp. -- The Moisture Sensitivity Level rating according to the JEDEC industry standard classifications, and peak solder temperature.

**Important Information and Disclaimer:** The information provided on this page represents TI's knowledge and belief as of the date that it is provided. TI bases its knowledge and belief on information provided by third parties, and makes no representation or warranty as to the accuracy of such information. Efforts are underway to better integrate information from third parties. TI has taken and continues to take reasonable steps to provide representative and accurate information but may not have conducted destructive testing or chemical analysis on incoming materials and chemicals. TI and TI suppliers consider certain information to be proprietary, and thus CAS numbers and other limited information may not be available for release.

In no event shall TI's liability arising out of such information exceed the total purchase price of the TI part(s) at issue in this document sold by TI to Customer on an annual basis.

**OTHER QUALIFIED VERSIONS OF TL971-Q1, TL972-Q1, TL974-Q1 :**

- Catalog: [TL971](#), [TL972](#), [TL974](#)

NOTE: Qualified Version Definitions:

- Catalog - TI's standard catalog product

PW (R-PDSO-G14)

PLASTIC SMALL OUTLINE



- NOTES:
- A. All linear dimensions are in millimeters. Dimensioning and tolerancing per ASME Y14.5M-1994.
  - B. This drawing is subject to change without notice.
  - C. Body length does not include mold flash, protrusions, or gate burrs. Mold flash, protrusions, or gate burrs shall not exceed 0,15 each side.
  - D. Body width does not include interlead flash. Interlead flash shall not exceed 0,25 each side.
  - E. Falls within JEDEC MO-153

PW (R-PDSO-G14)

PLASTIC SMALL OUTLINE

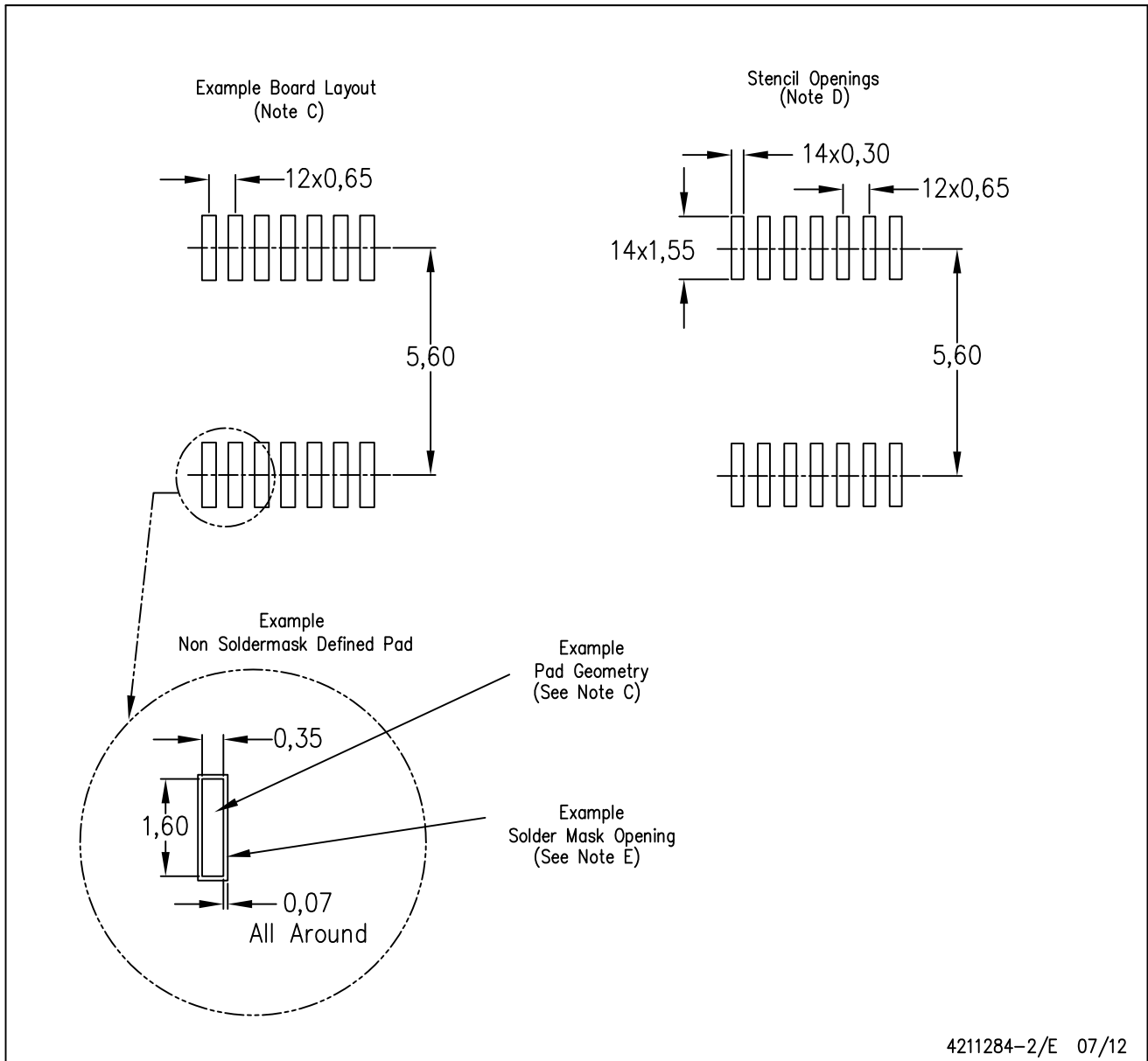

- NOTES:
- All linear dimensions are in millimeters.
  - This drawing is subject to change without notice.
  - Publication IPC-7351 is recommended for alternate designs.
  - Laser cutting apertures with trapezoidal walls and also rounding corners will offer better paste release. Customers should contact their board assembly site for stencil design recommendations. Refer to IPC-7525 for other stencil recommendations.
  - Customers should contact their board fabrication site for solder mask tolerances between and around signal pads.

D (R-PDSO-G8)

PLASTIC SMALL OUTLINE

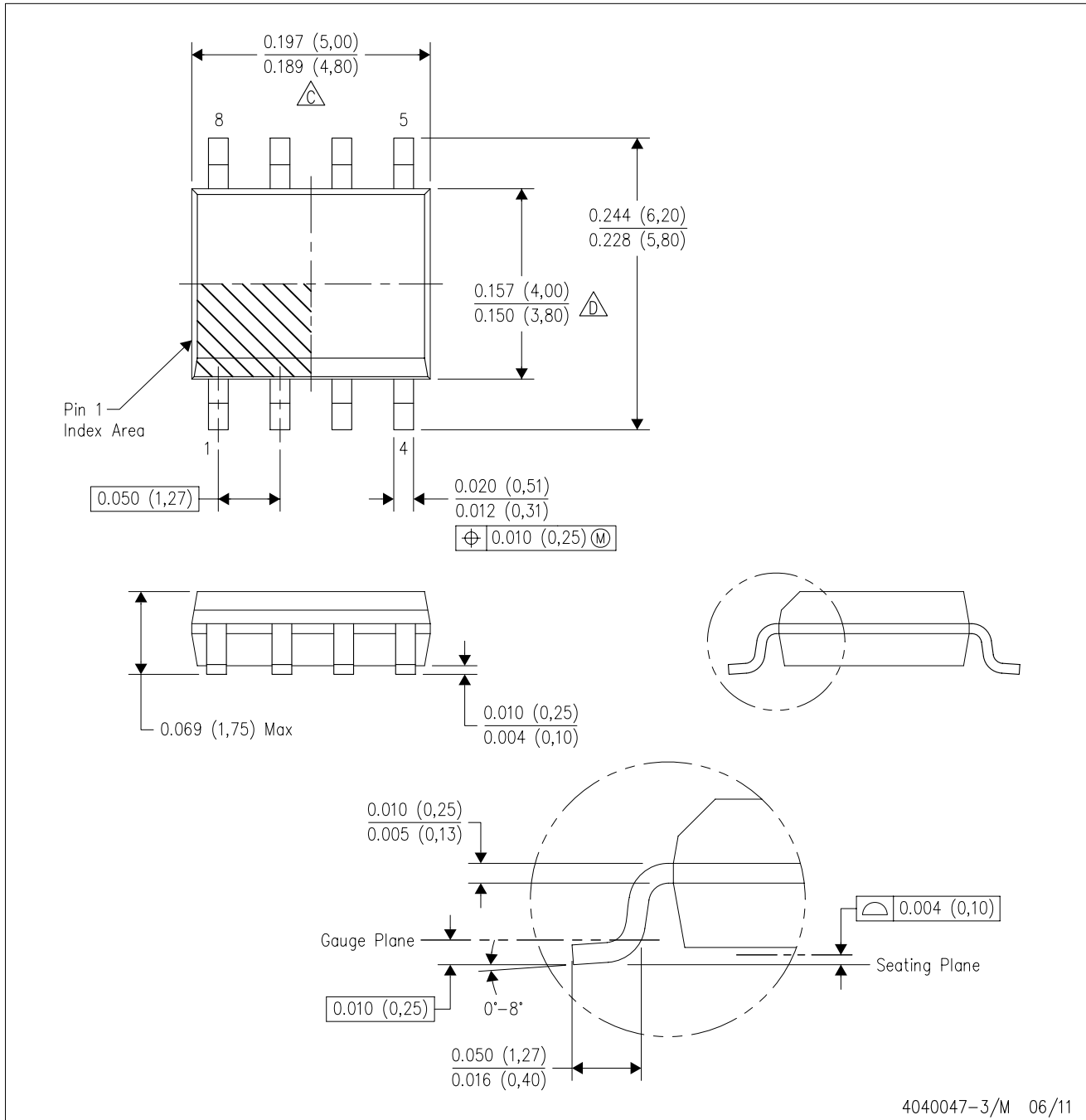

- NOTES:
- A. All linear dimensions are in inches (millimeters).
  - B. This drawing is subject to change without notice.
  - $\triangle C$  Body length does not include mold flash, protrusions, or gate burrs. Mold flash, protrusions, or gate burrs shall not exceed 0.006 (0,15) each side.
  - $\triangle D$  Body width does not include interlead flash. Interlead flash shall not exceed 0.017 (0,43) each side.
  - E. Reference JEDEC MS-012 variation AA.

D (R-PDSO-G8)

PLASTIC SMALL OUTLINE



4211283-2/E 08/12

- NOTES:
- A. All linear dimensions are in millimeters.
  - B. This drawing is subject to change without notice.
  - C. Publication IPC-7351 is recommended for alternate designs.
  - D. Laser cutting apertures with trapezoidal walls and also rounding corners will offer better paste release. Customers should contact their board assembly site for stencil design recommendations. Refer to IPC-7525 for other stencil recommendations.
  - E. Customers should contact their board fabrication site for solder mask tolerances between and around signal pads.

PW (R-PDSO-G8)

PLASTIC SMALL OUTLINE

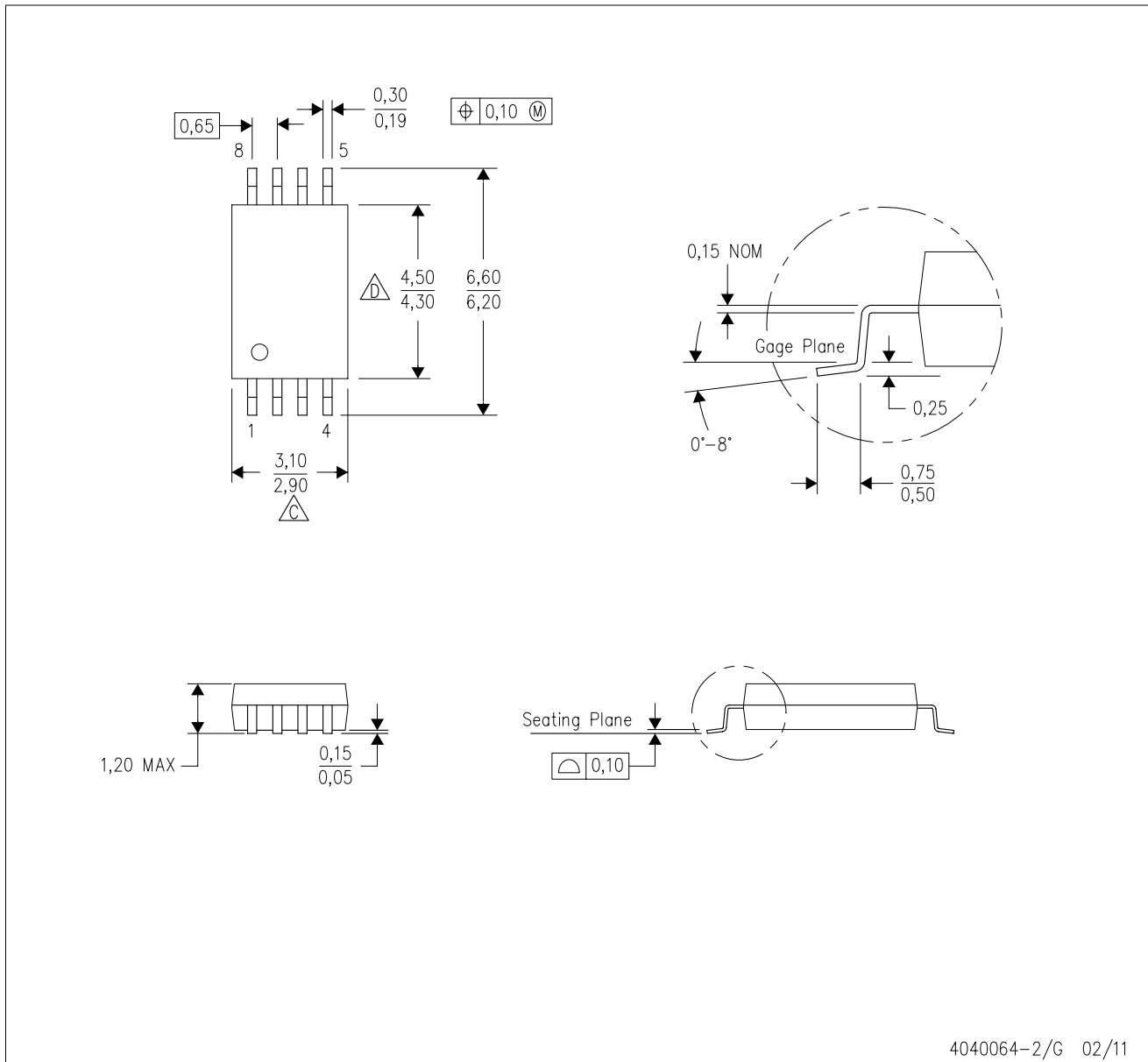

4040064-2/G 02/11

- NOTES:
- A. All linear dimensions are in millimeters. Dimensioning and tolerancing per ASME Y14.5M-1994.
  - B. This drawing is subject to change without notice.
  - C. Body length does not include mold flash, protrusions, or gate burrs. Mold flash, protrusions, or gate burrs shall not exceed 0,15 each side.
  - D. Body width does not include interlead flash. Interlead flash shall not exceed 0,25 each side.
  - E. Falls within JEDEC MO-153

## IMPORTANT NOTICE

Texas Instruments Incorporated and its subsidiaries (TI) reserve the right to make corrections, enhancements, improvements and other changes to its semiconductor products and services per JESD46, latest issue, and to discontinue any product or service per JESD48, latest issue. Buyers should obtain the latest relevant information before placing orders and should verify that such information is current and complete. All semiconductor products (also referred to herein as "components") are sold subject to TI's terms and conditions of sale supplied at the time of order acknowledgment.

TI warrants performance of its components to the specifications applicable at the time of sale, in accordance with the warranty in TI's terms and conditions of sale of semiconductor products. Testing and other quality control techniques are used to the extent TI deems necessary to support this warranty. Except where mandated by applicable law, testing of all parameters of each component is not necessarily performed.

TI assumes no liability for applications assistance or the design of Buyers' products. Buyers are responsible for their products and applications using TI components. To minimize the risks associated with Buyers' products and applications, Buyers should provide adequate design and operating safeguards.

TI does not warrant or represent that any license, either express or implied, is granted under any patent right, copyright, mask work right, or other intellectual property right relating to any combination, machine, or process in which TI components or services are used. Information published by TI regarding third-party products or services does not constitute a license to use such products or services or a warranty or endorsement thereof. Use of such information may require a license from a third party under the patents or other intellectual property of the third party, or a license from TI under the patents or other intellectual property of TI.

Reproduction of significant portions of TI information in TI data books or data sheets is permissible only if reproduction is without alteration and is accompanied by all associated warranties, conditions, limitations, and notices. TI is not responsible or liable for such altered documentation. Information of third parties may be subject to additional restrictions.

Resale of TI components or services with statements different from or beyond the parameters stated by TI for that component or service voids all express and any implied warranties for the associated TI component or service and is an unfair and deceptive business practice. TI is not responsible or liable for any such statements.

Buyer acknowledges and agrees that it is solely responsible for compliance with all legal, regulatory and safety-related requirements concerning its products, and any use of TI components in its applications, notwithstanding any applications-related information or support that may be provided by TI. Buyer represents and agrees that it has all the necessary expertise to create and implement safeguards which anticipate dangerous consequences of failures, monitor failures and their consequences, lessen the likelihood of failures that might cause harm and take appropriate remedial actions. Buyer will fully indemnify TI and its representatives against any damages arising out of the use of any TI components in safety-critical applications.

In some cases, TI components may be promoted specifically to facilitate safety-related applications. With such components, TI's goal is to help enable customers to design and create their own end-product solutions that meet applicable functional safety standards and requirements. Nonetheless, such components are subject to these terms.

No TI components are authorized for use in FDA Class III (or similar life-critical medical equipment) unless authorized officers of the parties have executed a special agreement specifically governing such use.

Only those TI components which TI has specifically designated as military grade or "enhanced plastic" are designed and intended for use in military/aerospace applications or environments. Buyer acknowledges and agrees that any military or aerospace use of TI components which have **not** been so designated is solely at the Buyer's risk, and that Buyer is solely responsible for compliance with all legal and regulatory requirements in connection with such use.

TI has specifically designated certain components which meet ISO/TS16949 requirements, mainly for automotive use. Components which have not been so designated are neither designed nor intended for automotive use; and TI will not be responsible for any failure of such components to meet such requirements.

### Products

Audio	<a href="http://www.ti.com/audio">www.ti.com/audio</a>
Amplifiers	<a href="http://amplifier.ti.com">amplifier.ti.com</a>
Data Converters	<a href="http://dataconverter.ti.com">dataconverter.ti.com</a>
DLP® Products	<a href="http://www.dlp.com">www.dlp.com</a>
DSP	<a href="http://dsp.ti.com">dsp.ti.com</a>
Clocks and Timers	<a href="http://www.ti.com/clocks">www.ti.com/clocks</a>
Interface	<a href="http://interface.ti.com">interface.ti.com</a>
Logic	<a href="http://logic.ti.com">logic.ti.com</a>
Power Mgmt	<a href="http://power.ti.com">power.ti.com</a>
Microcontrollers	<a href="http://microcontroller.ti.com">microcontroller.ti.com</a>
RFID	<a href="http://www.ti-rfid.com">www.ti-rfid.com</a>
OMAP Applications Processors	<a href="http://www.ti.com/omap">www.ti.com/omap</a>
Wireless Connectivity	<a href="http://www.ti.com/wirelessconnectivity">www.ti.com/wirelessconnectivity</a>

### Applications

Automotive and Transportation	<a href="http://www.ti.com/automotive">www.ti.com/automotive</a>
Communications and Telecom	<a href="http://www.ti.com/communications">www.ti.com/communications</a>
Computers and Peripherals	<a href="http://www.ti.com/computers">www.ti.com/computers</a>
Consumer Electronics	<a href="http://www.ti.com/consumer-apps">www.ti.com/consumer-apps</a>
Energy and Lighting	<a href="http://www.ti.com/energy">www.ti.com/energy</a>
Industrial	<a href="http://www.ti.com/industrial">www.ti.com/industrial</a>
Medical	<a href="http://www.ti.com/medical">www.ti.com/medical</a>
Security	<a href="http://www.ti.com/security">www.ti.com/security</a>
Space, Avionics and Defense	<a href="http://www.ti.com/space-avionics-defense">www.ti.com/space-avionics-defense</a>
Video and Imaging	<a href="http://www.ti.com/video">www.ti.com/video</a>

### TI E2E Community

[e2e.ti.com](http://e2e.ti.com)