

J-FET INPUT SINGLE OP-AMPS

- LOW POWER CONSUMPTION
- WIDE COMMON-MODE AND DIFFERENTIAL VOLTAGE RANGE
- LOW INPUT BIAS AND OFFSET CURRENT
- OUTPUT SHORT-CIRCUIT PROTECTION
- HIGH INPUT IMPEDANCE J-FET INPUT STAGE
- INTERNAL FREQUENCY COMPENSATION
- LATCH UP FREE OPERATION
- HIGH SLEW RATE : 13 V/μs (typ)

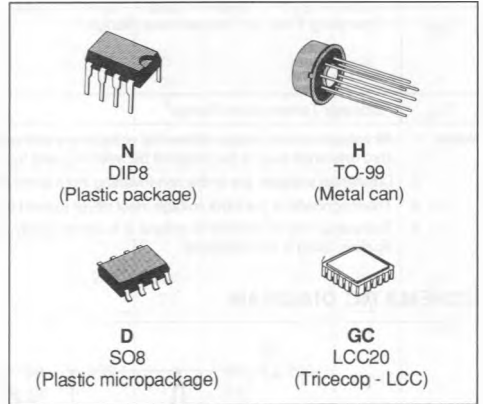

DESCRIPTION

The TL081, TL081A and TL081C are high speed J-FET input single operational amplifiers incorporating well matched, high voltage J-FET and bipolar transistors in a monolithic integrated circuit.

The devices feature high slew rates, low input bias and offset current, and low offset voltage temperature coefficient.

ORDER CODES

Part Number	Temperature Range	Package			
		N	H	D	GC
TL082M	- 55 °C to + 125 °C		•		•
TL082I	- 40 °C to + 105 °C	•		•	
TL082C	0 °C to + 70 °C	•		•	
TL082AC	0 °C to + 70 °C	•		•	
TL082BC	0 °C to + 70 °C	•		•	

Note : Hi-Rel Versions Available
Examples : TL082CD, TL082MGC, TL082IN

PIN CONNECTIONS (Top views)

DIP8
SO8

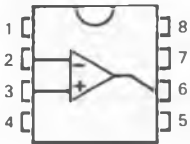

- 5 - Balance
- 6 - Output
- 7 - V_{CC}
- 8 - NC

TO-99

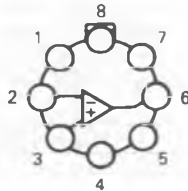

- 1 - Balance
- 2 - Inverting input
- 3 - Non-inverting input
- 4 - V_{CC}

LCC20

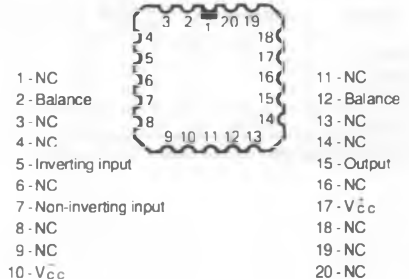

MAXIMUM RATINGS

Symbol	Parameter	Value	Unit
V_{CC}	Supply Voltage (note 1)	± 18	V
V_I	Input Voltage (note 3)	± 15	V
V_{ID}	Differential Input Voltage (note 2)	± 30	V
P_{tot}	Power Dissipation	680	mW
	Output Short-circuit Duration (note 4)	Indefinite	
T_{oper}	Operating Free Air Temperature Range	TL082C, AC, BC TL082I, BI TL082M	$^{\circ}C$
		0 to +70 -40 to +105 -55 to +125	
T_{sig}	Storage Temperature Range	-65 to +150	$^{\circ}C$

- Notes :**
1. All voltage values, except differential voltage, are with respect to the zero reference level (ground) of the supply voltages where the zero reference level is the midpoint between V_{CC} and V_{CC} .
 2. Differential voltages are at the non-inverting input terminal with respect to the inverting input terminal.
 3. The magnitude of the input voltage must never exceed the magnitude of the supply voltage or 15 volts, whichever is less.
 4. The output may be shorted to ground or to either supply. Temperature and /or supply voltages must be limited to ensure that the dissipation rating is not exceeded.

SCHEMATIC DIAGRAM

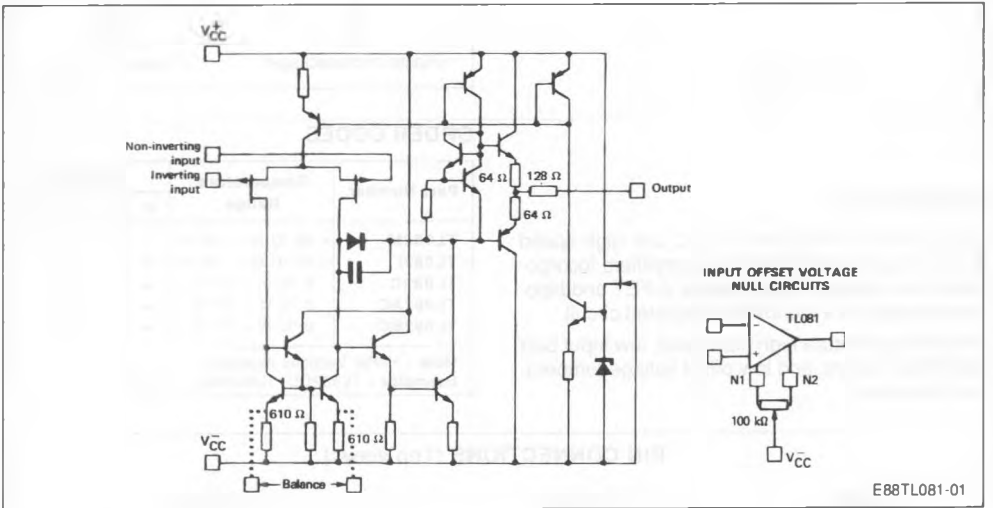

Case	Balance	Inverting Input	Non-inverting Input	Output	V_{CC}^+	V_{CC}^-	N.C.
DIP8 SO8 TO-99	1, 5	2	3	6	7	4	8
LCC20	2, 12	5	7	15	17	10	*

* LCC20 : Other pins are not connected.

ELECTRICAL CHARACTERISTICS

V_{CC} = ± 15 V (unless otherwise specified)

TL081M : - 55 °C ≤ T_{amb} ≤ + 125 °C

TL081I, BI : - 40 °C ≤ T_{amb} ≤ + 105 °C

TL081C, AC, BC: 0 °C ≤ T_{amb} ≤ + 70 °C

Symbol	Parameter	TL082M, I, BI TL082BC, AC			TL082C			Unit
		Min.	Typ.	Max.	Min.	Typ.	Max.	
V _{IO}	Input Offset Voltage T _{amb} = 25 °C (R _S ≤ 10 kΩ) TL082BI, BC T _{min} ≤ T _{amb} ≤ T _{max} TL082BI, BC		3 1	5 3 9 5		3 8 13		mV
DV _{IO}	Input Offset Voltage Drift		10			10		μV/°C
I _{IO}	Input Offset Current * T _{amb} = 25 °C T _{min} ≤ T _{amb} ≤ T _{max}		5	50 4		5 50 4		pA nA
I _{IB}	Input Bias Current * T _{amb} = 25 °C T _{min} ≤ T _{amb} ≤ + 70 °C		20	200 20		20 200 20		pA nA
A _{VD}	Large Signal Voltage Gain (R _L ≥ 2 kΩ, V _O = ± 10 V) T _{amb} = 25 °C T _{min} ≤ T _{amb} ≤ T _{max}	50 25	200		50 25	200		V/mV
SVR	Supply Voltage Rejection Ratio (R _S ≤ 10 kΩ) T _{amb} = 25 °C T _{min} ≤ T _{amb} ≤ T _{max}	80 80	86		80 80	86		dB
I _{CC}	Supply Current, per Amp, no Load T _{amb} = 25 °C T _{min} ≤ T _{amb} ≤ T _{max}		1.4	2.5 2.5		1.4 2.5 2.5		mA
V _I	Input Voltage Range	- 11		+ 11	- 11		+ 11	V
CMR	Common Mode Rejection Ratio (R _S ≤ 10 kΩ) T _{amb} = 25 °C T _{min} ≤ T _{amb} ≤ T _{max}	80 80	86		70 70	86		dB
I _{OS}	Output Short-circuit Current T _{amb} = 25 °C T _{min} ≤ T _{amb} ≤ T _{max}	10 10	40	60 60	10 10	40 60 60		mA
± V _{OPP}	Output Voltage Swing T _{amb} = 25 °C R _L ≥ 2 kΩ R _L ≥ 10 kΩ T _{min} ≤ T _{amb} ≤ T _{max} R _L ≥ 2 kΩ R _L ≥ 10 kΩ	11 12 11 12	12 13.5		11 12 11 12	12 13.5		V
S _{VO}	Slew-rate (V _I = 10 V, R _L = 2 kΩ C _L ≤ 100 pF, T _{amb} = 25 °C, unity gain)	12	16		8	16		V/μs
t _r	Rise Time (V _I = 20 mV, R _L = 2 kΩ C _L = 100 pF, T _{amb} = 25 °C, unity gain)		0.1			0.1		μs

* The input bias currents are junction leakage currents which approximately double for every 10 °C increase in the junction temperature.

ELECTRICAL CHARACTERISTICS (continued)

Symbol	Parameter	TL082M, I, BI TL082BC, AC			TL082C			Unit
		Min.	Typ.	Max.	Min.	Typ.	Max.	
K_{OV}	Overshoot ($V_I = 20$ mV, $R_L = 2$ k Ω $C_L \leq 100$ pF, $T_{amb} = 25$ °C, unity gain)		10			10		%
GBP	Gain Bandwidth Product ($f = 100$ kHz, $T_{amb} = 25$ °C $V_{IN} = 10$ mV, $R_L = 2$ k Ω , $C_L = 100$ pF) TL082BI, BC	2.5 3.3	4.0 4.0	5.0 5.0	2.5	4.0	5.0	MHz
R_i	Input Resistance ($T_{amb} = 25$ °C)		10^{12}			10^{12}		Ω
THD	Total Harmonic Distortion ($f = 1$ kHz, $A_V = 20$ dB, $R_L = 2$ k Ω $C_L \leq 100$ pF, $T_{amb} = 25$ °C, $V_O = 2$ V $_{PP}$)		0.01			0.01		%
V_n	Equivalent Input Noise Voltage ($f = 1$ kHz, $R_G = 100$ Ω)		15			15		nV/ \sqrt{Hz}
ϕ_m	Phase Margin		45			45		Degrees
V_{O1} / V_{O2}	Channel Separation $A_{vd} = 100$, $T_{amb} = 25$ °C		120			120		dB

TYPICAL CHARACTERISTICS

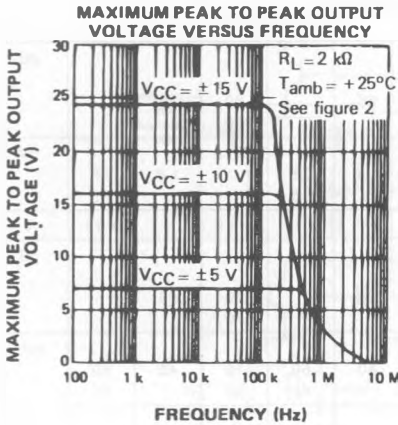

E88TL071-02

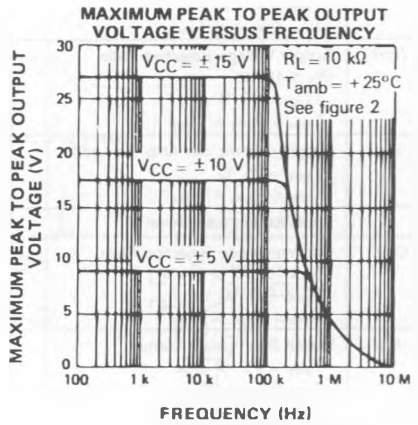

E88TL071-03

TYPICAL CHARACTERISTICS (continued)

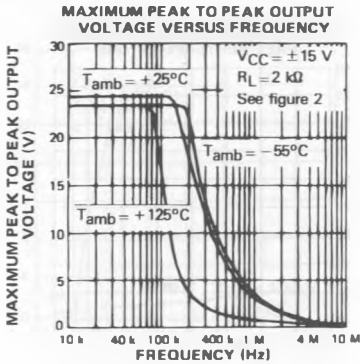

E88TL071-04

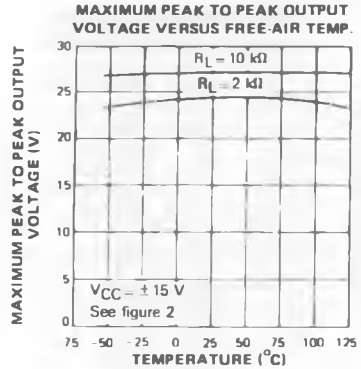

E88TL071-05

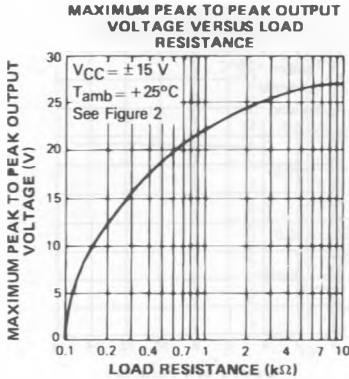

E88TL071-06

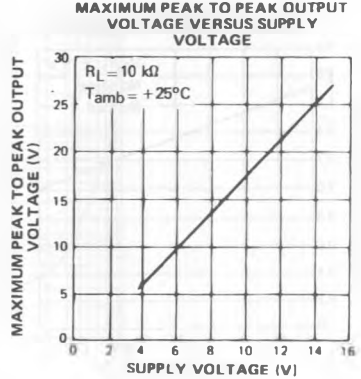

E88TL071-07

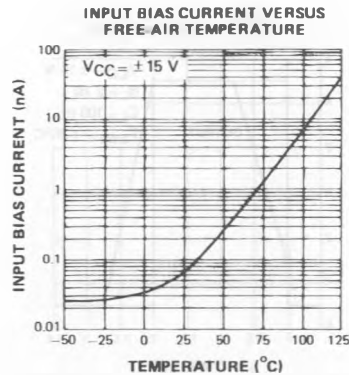

E88TL071-08

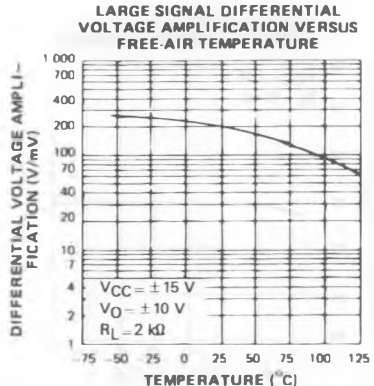

E88TL071-09

TYPICAL CHARACTERISTICS (continued)

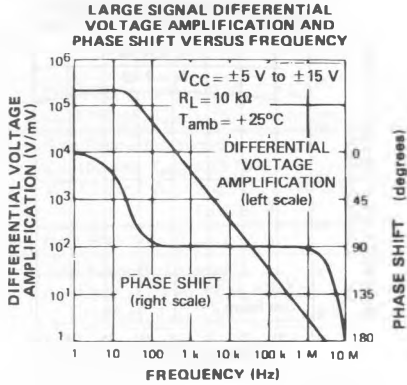

E88TL071-10

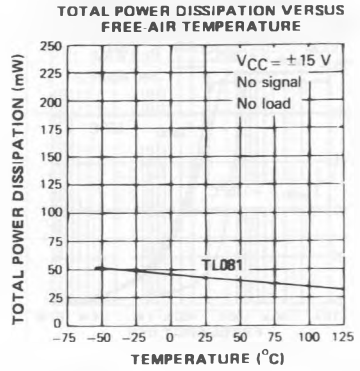

E88TL071-11

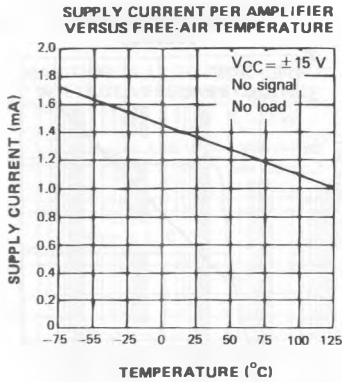

E88TL071-12

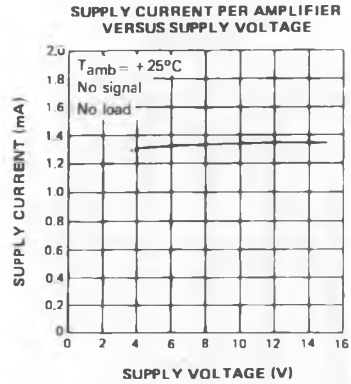

E88TL081-02

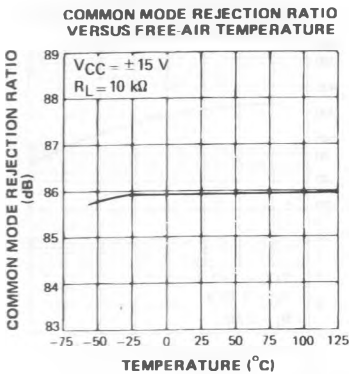

E88TL071-13

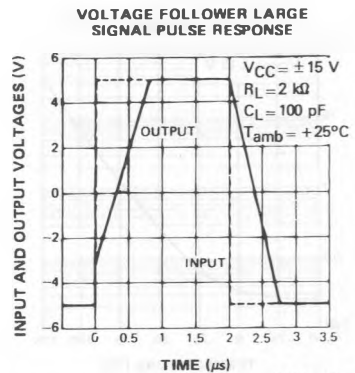

E88TL071-14

TYPICAL CHARACTERISTICS (continued)

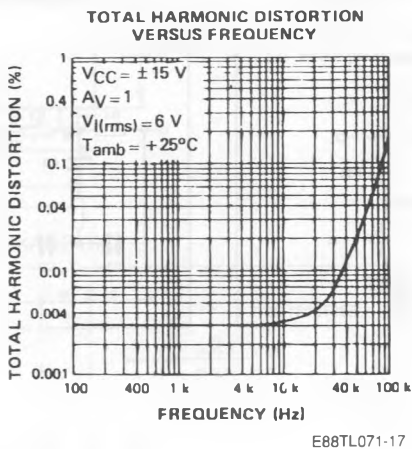
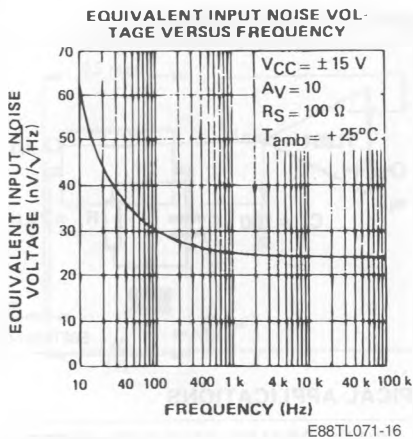
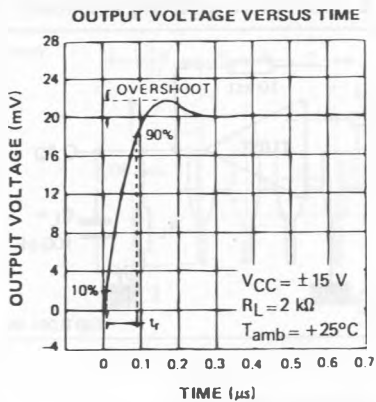

PARAMETER MEASUREMENT INFORMATION

Figure 1 : Voltage follower.

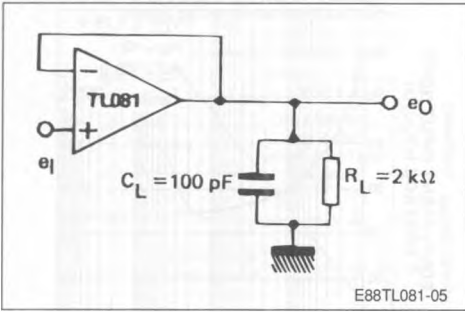
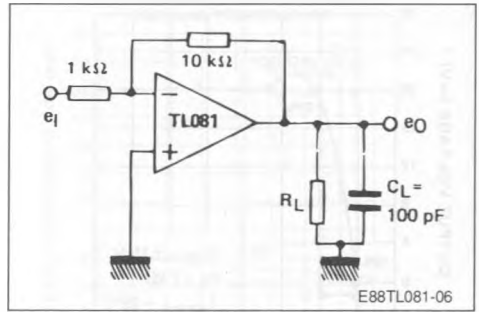
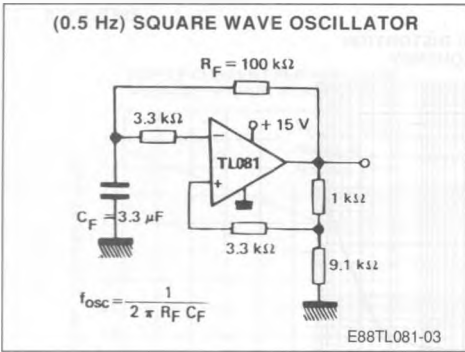

Figure 2 : Gain-of-10 inverting amplifier.



TYPICAL APPLICATIONS

(0.5 Hz) SQUARE WAVE OSCILLATOR



HIGH Q NOTCH FILTER

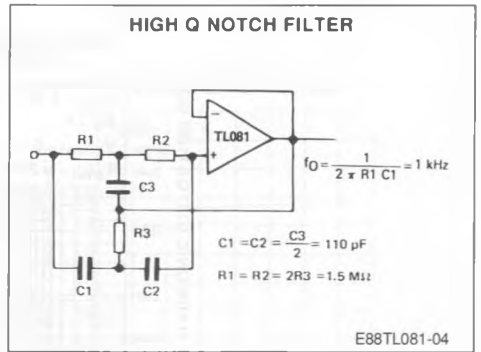

PACKAGE MECHANICAL DATA

8 PINS – PLASTIC DIP

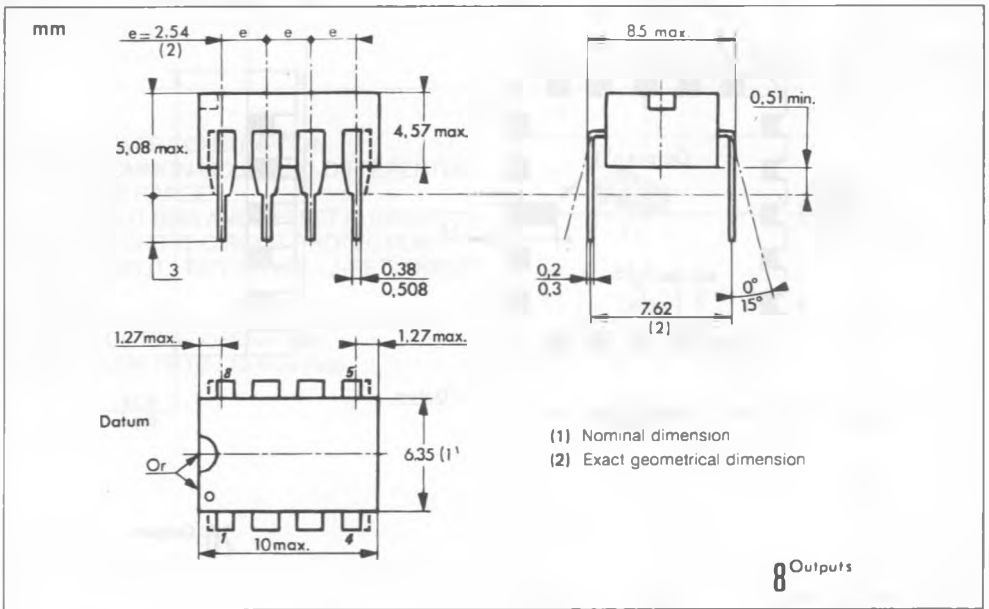

8 PINS – PLASTIC MICROPACKAGE (SO)

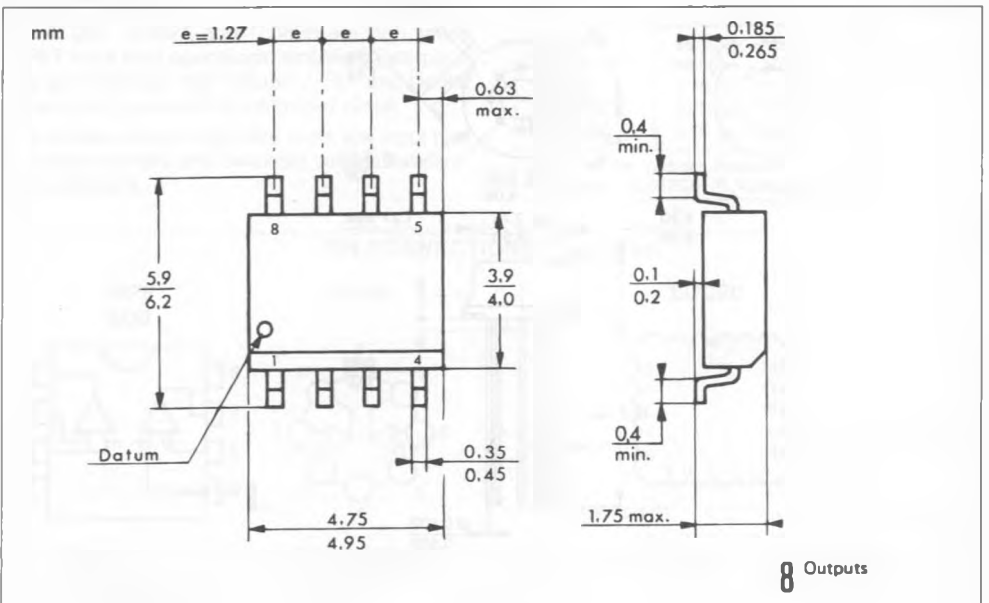

20 PINS – TRICECOP (LCC)

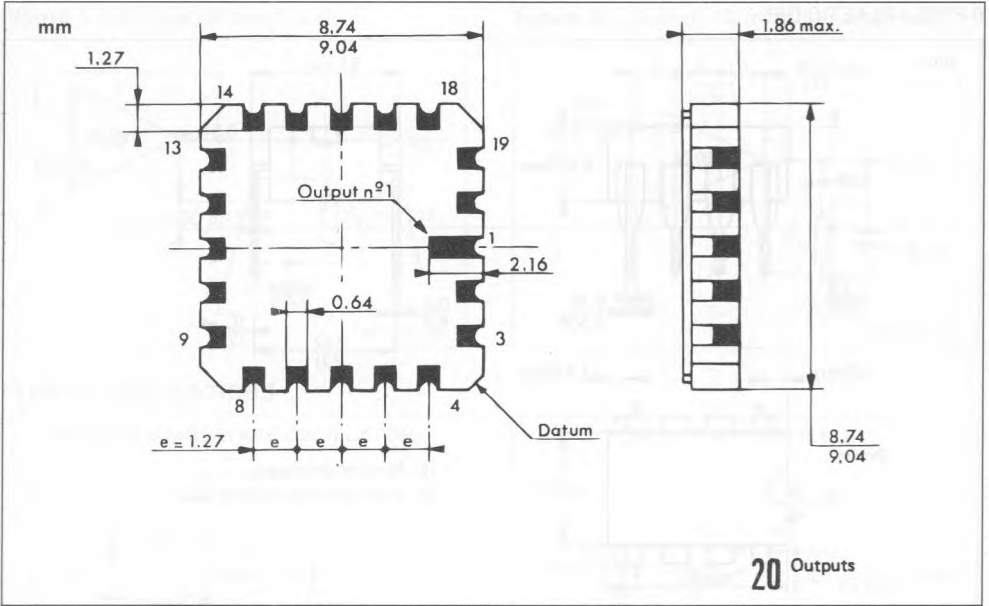

TO-99 – METAL CAN

