

**TEA5704 - STV5712 DEMOBOARD USER'S
INSTRUCTION AND CHARACTERISTICS**

SUMMARY		Page
I	INTRODUCTION	1
II	DEMOBOARD ELECTRICAL DIAGRAM	1
III	OPTIONS GIVEN BY THE LAYOUT OF THE PRINTED CIRCUIT BOARD	1
IV.1	PRINTED CIRCUIT BOARD LAYOUT	4
IV.2	SILKSCREEN PRINTING	4
V	MEASUREMENTS RESULTS	5

I - INTRODUCTION

The demoboard is intended to provide the user with an example of application of the SGS-THOMSON head amplifiers TEA5704/STV5712.

Although the demoboard is just an example, a lot of care have been taken in making the layout of the printed copper board, and the component dimensioning.

To better understand the operation of the TEA5704 and STV5712, the user can refer to the relevant SGS-THOMSON's application note : "VCR Record and Playback Head Amplifiers" (AN445).

Remark : The typical application diagrams given in this document are updated versions of the typical application diagrams given in the application note.

II - DEMOBOARD ELECTRICAL DIAGRAM

The demonstration board has been mounted according to the typical application diagram given in Figure 2.

Compared with the simplest application diagram , the potentiometers V_{R1} , V_{R2} and V_{R101} have been added in the record signals input section in order to allow the user to adjust the input level at his convenience.

III - OPTIONS GIVEN BY THE LAYOUT OF THE PRINTED CIRCUIT BOARD (PCB)(Figure 3)

The layout of the PCB has been designed in order to give to the user the opportunity to evaluate the integrated circuits TEA5704/STV5712 in configura-

tions different from the typical application diagram.

The layout of the PCB allows the following options :

- Addition of capacitors in the playback preamplifier section for adjusting the peaking effect in the frequency response (C22, C23, C24, C25, C109, C110).

- Implementation of an FM equalizing circuit at the luma output (R11, C16, L3, Q1, R12).

- To filter the control signals (C14, C15).

This filtering is not mandatory, however some users use it to prevent the application from parasitics induced in the control wires.

- To use only one supply line for both playback and record modes (TEA5704).

In this option the V_{REC} line is provided from the V_{CC} line through a switching circuit made by : Q2, Q3, R15, R16, R17, R18. The record mode is controlled by a signal provided at Pin Pb/REC of connector J2 (Figure 1) (L2 is naturally removed).

Figure 1

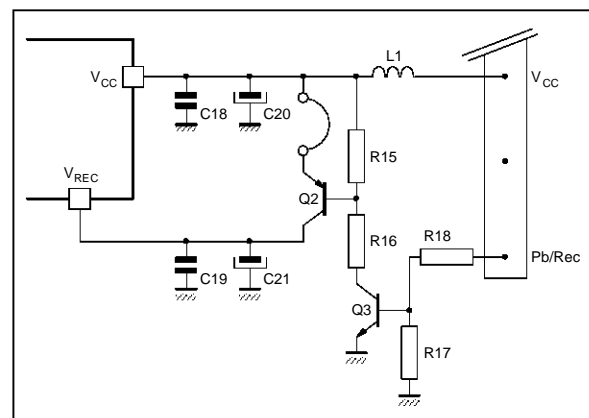

AN640-01.EPS

TEA5704 - STV5712 DEMOBOARD

Figure 2 : Electrical Diagram of the Demonstration Board

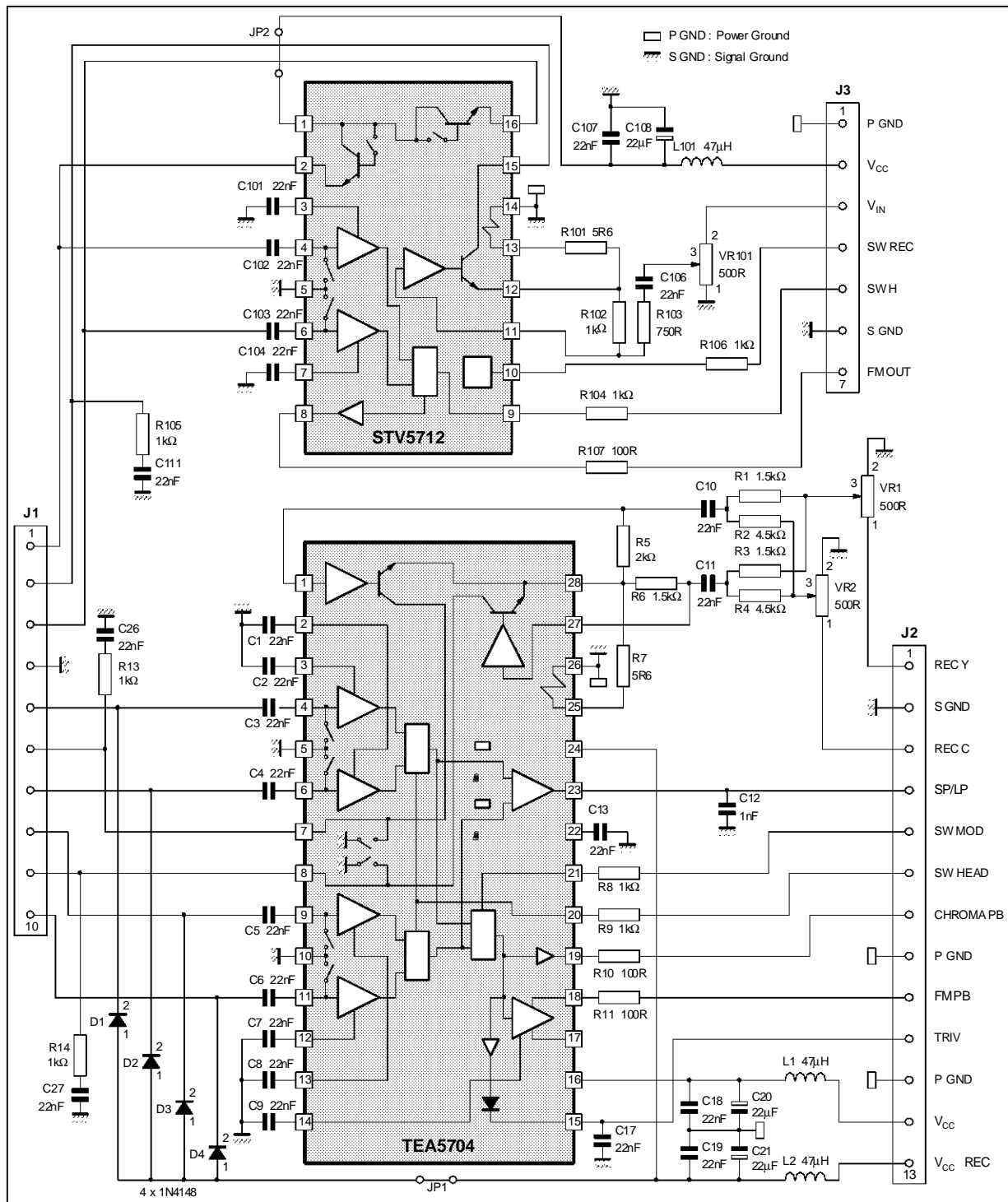

AN640-02.EPS

TEA5704 - STV5712 DEMOBOARD

Figure 3 : Example of an application which uses all the options of the PCB layout

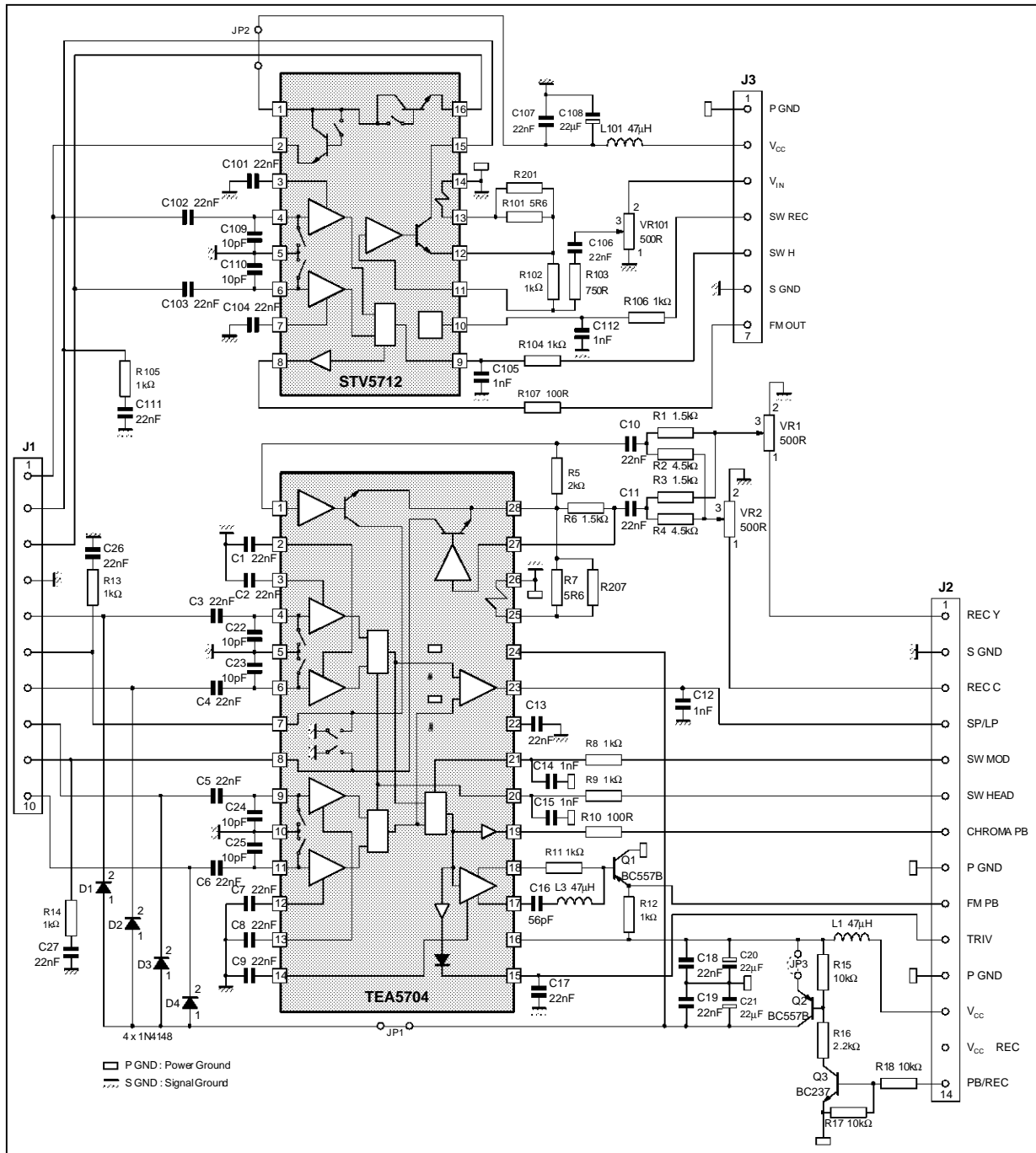

ANG640-03.EPS

TEA5704 - STV5712 DEMOBOARD

IV.1 - Printed Circuit Board Layout

Figure 4

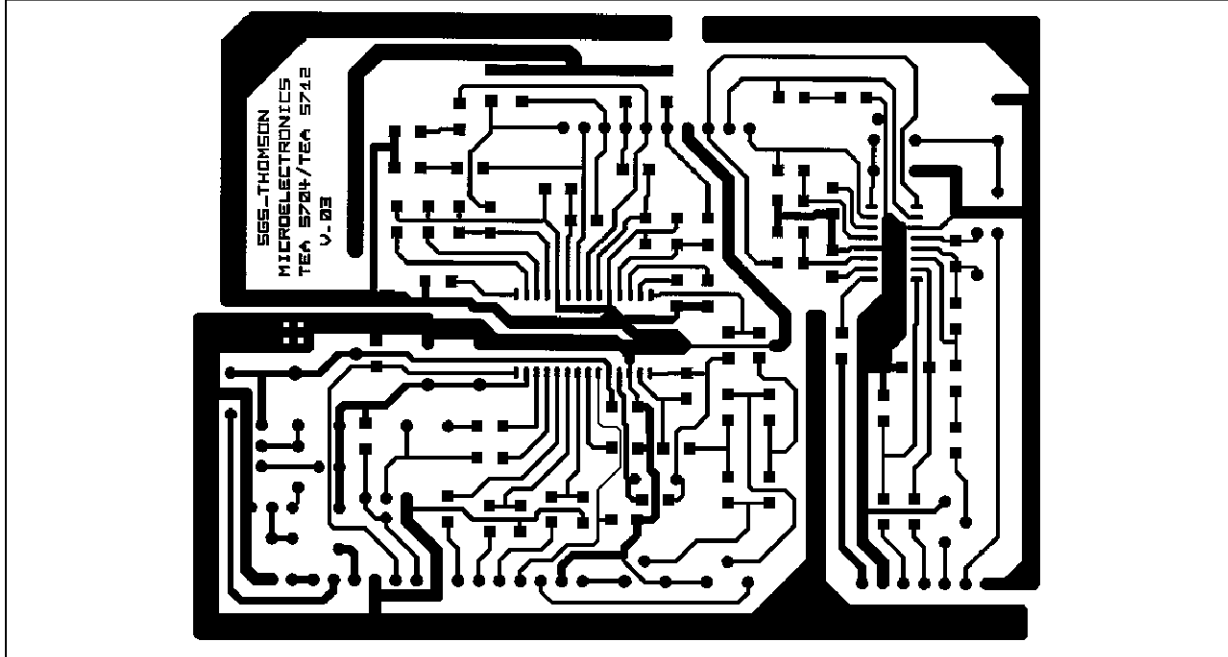

AN640-04.IMG

IV.2 - Silkscreen Printing

Figure 5

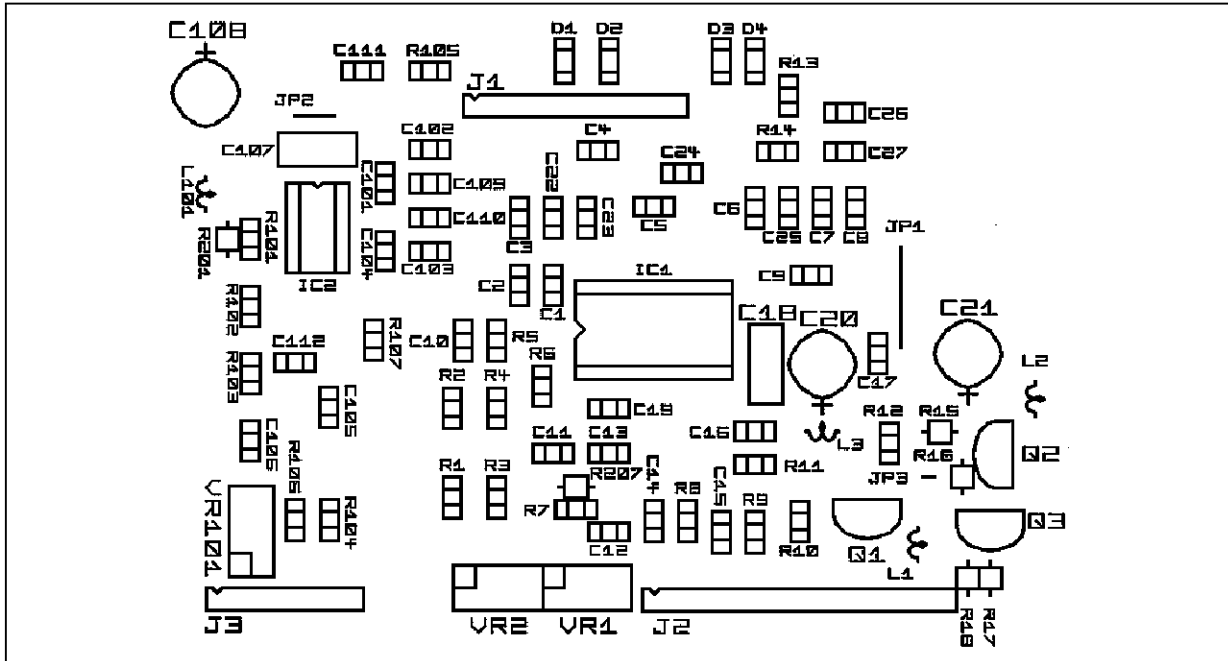

AN640-05.IMG

V - MEASUREMENTS RESULTS

In order to characterize the integrated circuits and the application, the following measurements have been given :

TEA5704 Application

a. PLAYBACK MODE

- luma output bandwidth all channels
- chroma output bandwidth all channels
- chroma output harmonic 2, $f_{IN} = 3.8\text{MHz}$
- chroma output harmonic 2, $f_{IN} = 6\text{MHz}$
- luma output harmonic 2, $f_{IN} = 3.8\text{MHz}$
- luma output harmonic 2, $f_{IN} = 6\text{MHz}$
- crosstalk between channels
- equivalent input voltage and current noise

b. RECORD MODE

- bandwidth with different output currents
- harmonic 2 for $f_{IN} = 3.8\text{MHz}$
- harmonic 2 for $f_{IN} = 6\text{MHz}$
- bandwidth measured with drum
- harmonic 2 and bandwidth versus V_{REC} value
- intermodulation

STV5712 Application

a. PLAYBACK MODE

- bandwidth
- harmonic 2

- crosstalk
- b. RECORD MODE
- harmonic 2
- bandwidth

Remarks :

1. The measurements have been made with an application board corresponding with the electrical diagram given in Figure 2.
2. Regarding the load used in playback mode. $Z : 470\Omega//47\text{pF}$ has been chosen in order to give results in a case close to the application.
3. Most of the measurements have been made with a spectrum analyser : HP4195A equipped with active probes HP41800A.

V.1 - TEA5704 Application

V.1.a - TEA5704 Playback Mode

LUMA/CHROMA OUTPUTS BANDWIDTH AND HARMONIC 2 MEASURING METHOD

See Figure 6

- Bandwidth
 - For chroma output the bandwidth is measured for $V_{OUT} = 400\text{mVp-pk}$ ($f_{REF} = 600\text{kHz}$)
 - For luma output the bandwidth is measured for $V_{IN} = 200\mu\text{Vp-pk}$ ($f_{REF} = 3.8\text{MHz}$)
- Harmonic 2
 - Harmonic 2 is measured with $V_{IN} = 400\mu\text{Vp-pk}$

Figure 6

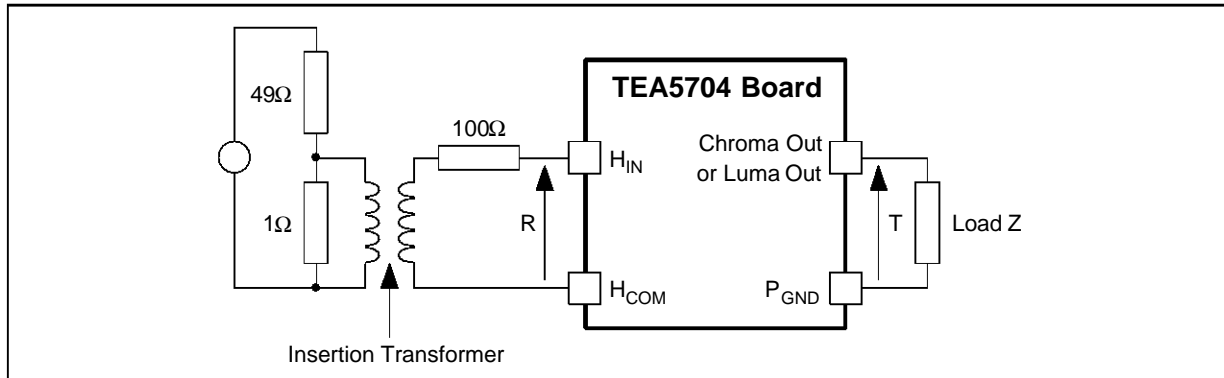

AN640-06.EPS

TEA5704 - STV5712 DEMOBOARD

LUMA OUTPUT BANDWIDTH (Z = 470Ω/47pF)

Figure 7 : H2LP

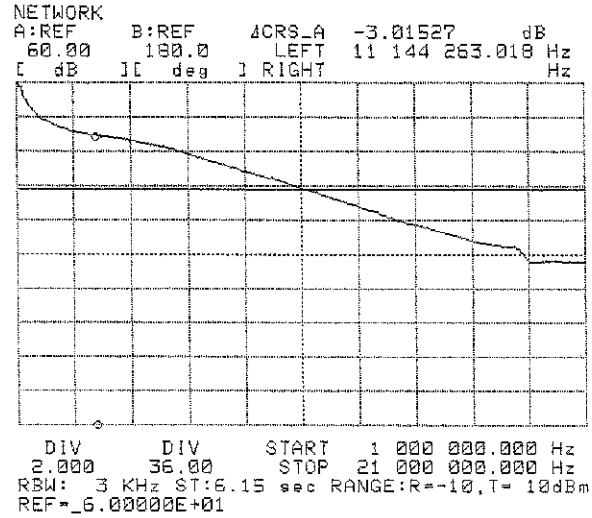

Figure 8 : H1LP

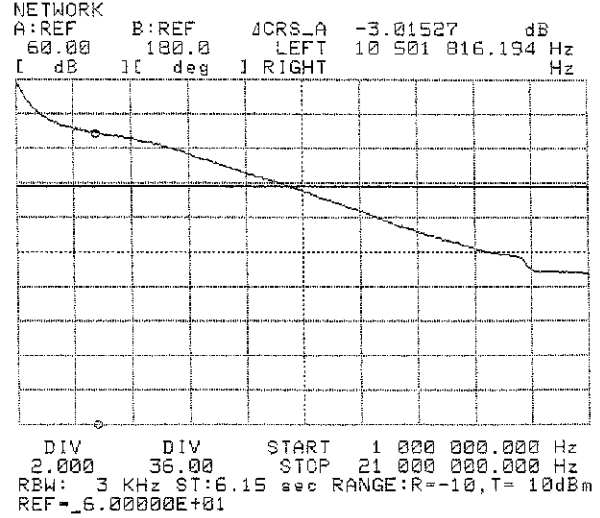

Figure 9 : H1SP

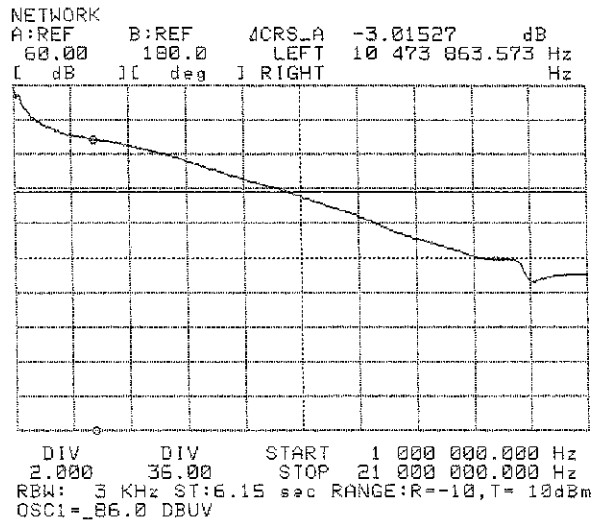
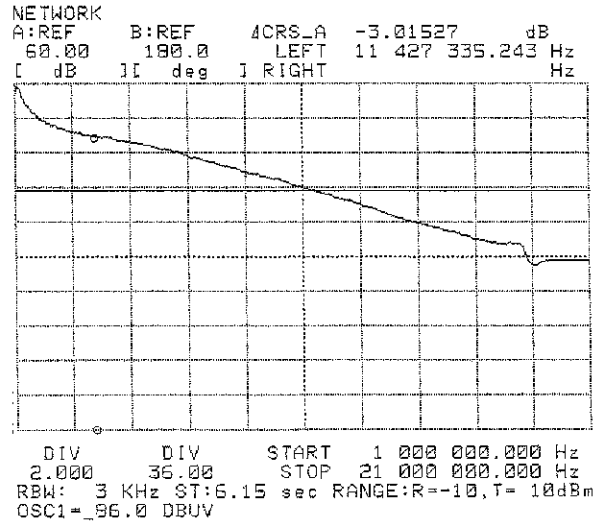

Figure 10 : H2SP



CHROMA OUTPUT BANDWIDTH ALL CHANNELS (Z = 470Ω//47pF)

Figure 11 : H1SP

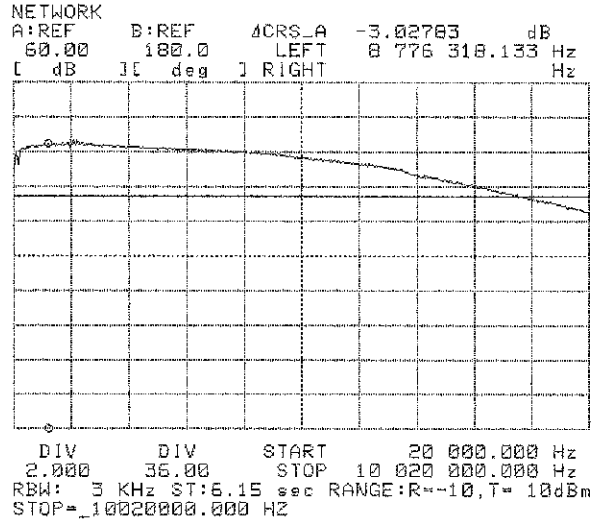

Figure 12 : H2SP

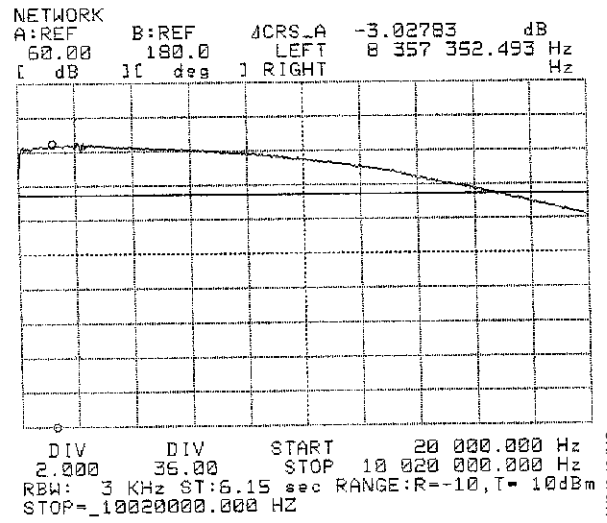

Figure 13 : H2LP

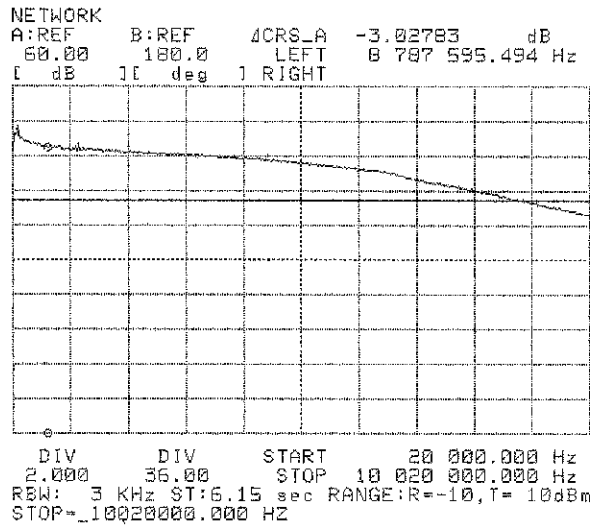
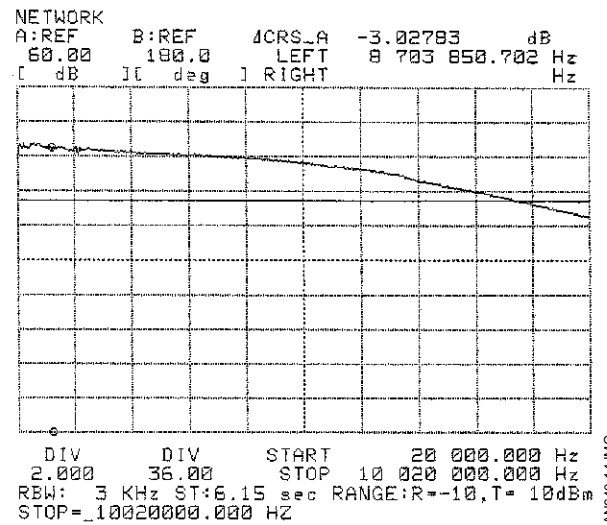

Figure 14 : H1LP



TEA5704 - STV5712 DEMOBOARD

HARMONIC 2 / CHROMA OUTPUT (all channels $f_{IN} = 3.8\text{MHz}$, $Z = 470\Omega//100\text{pF}$)

Figure 15 : H1SP

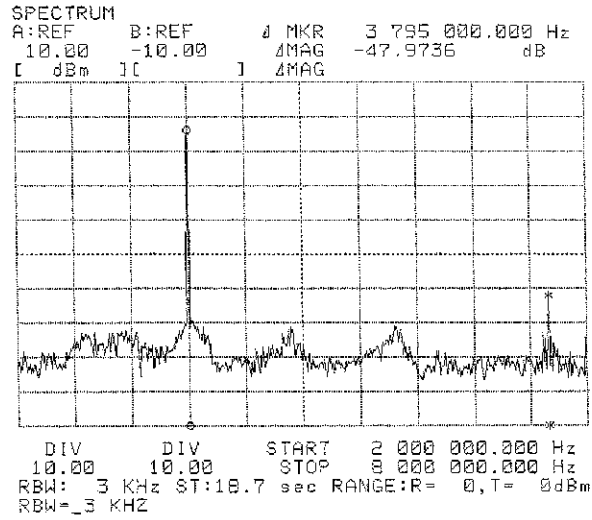

ANG40-15.IMG

Figure 16 : H2SP

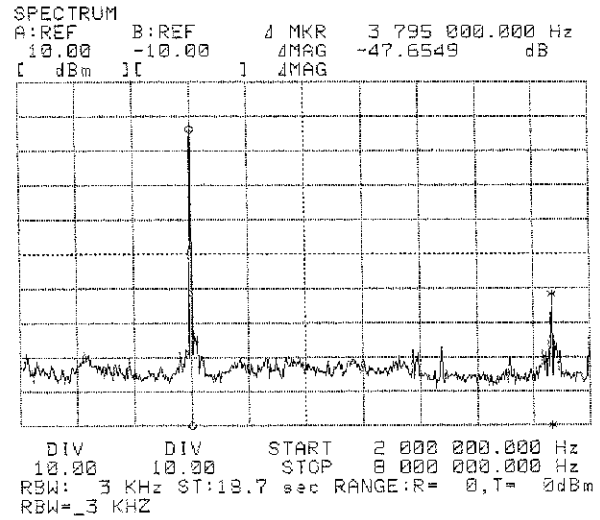

ANG40-16.IMG

Figure 17 : H2LP

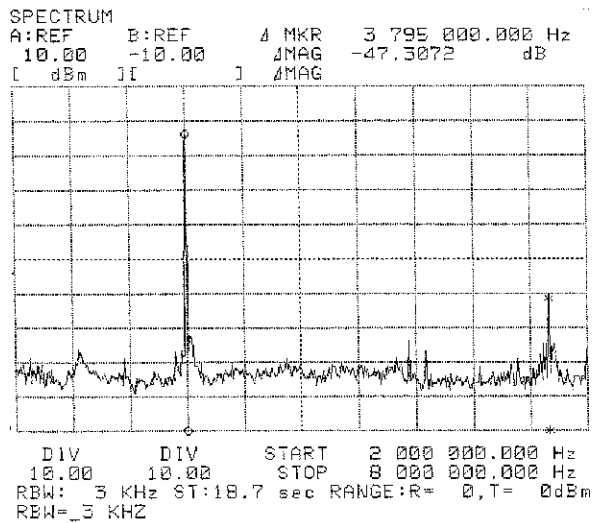

ANG40-17.IMG

Figure 18 : H1LP

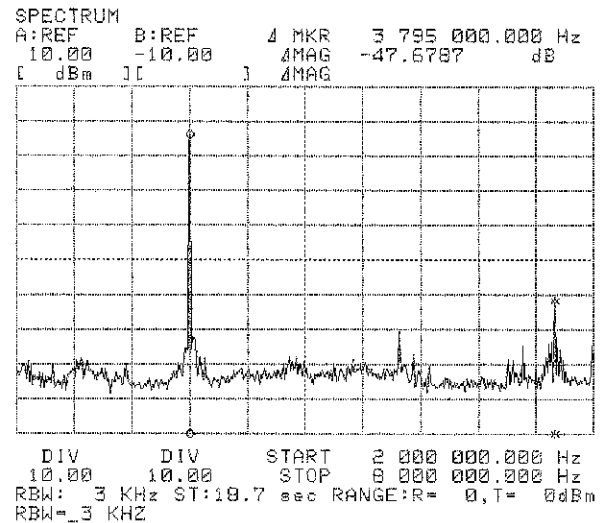

ANG40-18.IMG

HARMONIC 2 / CHROMA OUTPUT ($f_{IN} = 6\text{MHz} - \text{H2LP}$)

Figure 19 : $Z = 470\Omega$

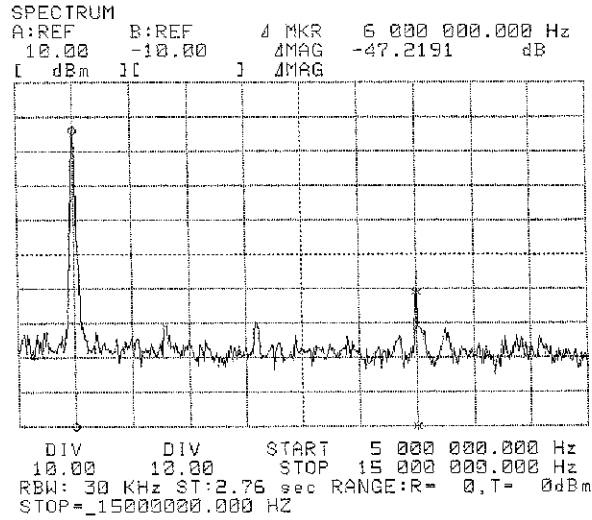
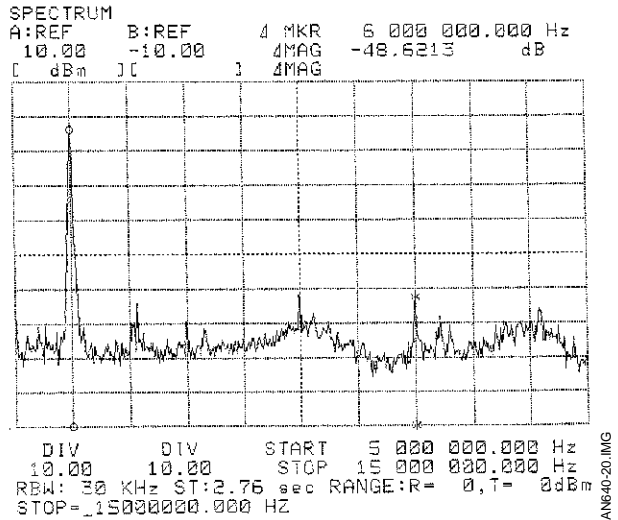

Figure 20 : $Z = 470\Omega//100\text{pF}$



HARMONIC 2 / LUMA OUTPUT ($f_{IN} = 3.8\text{MHz} - \text{H2LP}$)

Figure 21 : $Z = 470\Omega$

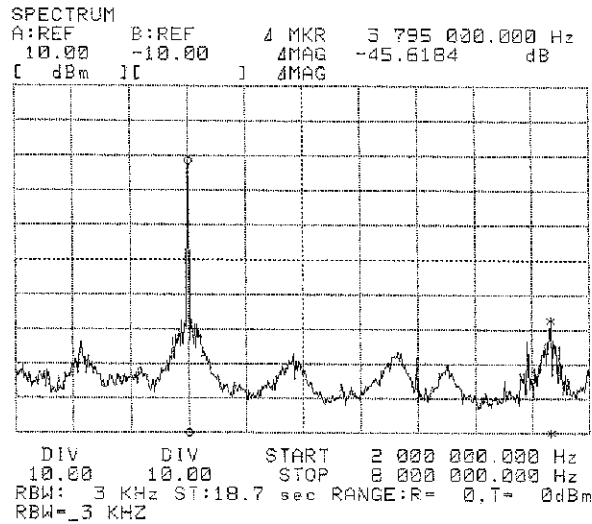
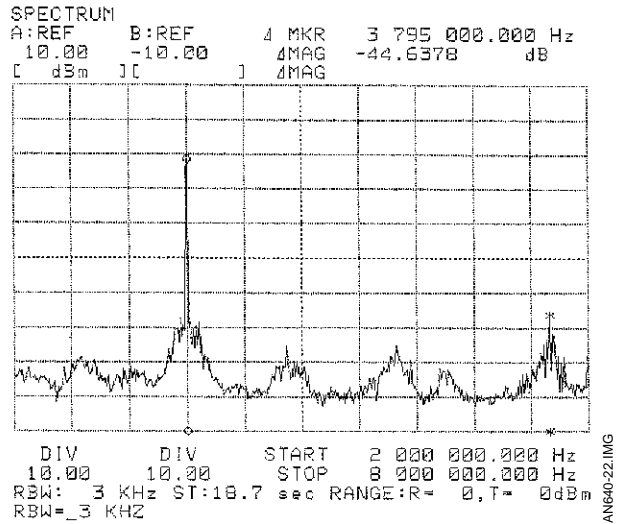

Figure 22 : $Z = 470\Omega//100\text{pF}$



TEA5704 - STV5712 DEMOBOARD

HARMONIC 2 / LUMA OUTPUT ($f_{IN} = 6\text{MHz} - \text{H2LP}$)

Figure 23 : $Z = 470\Omega$

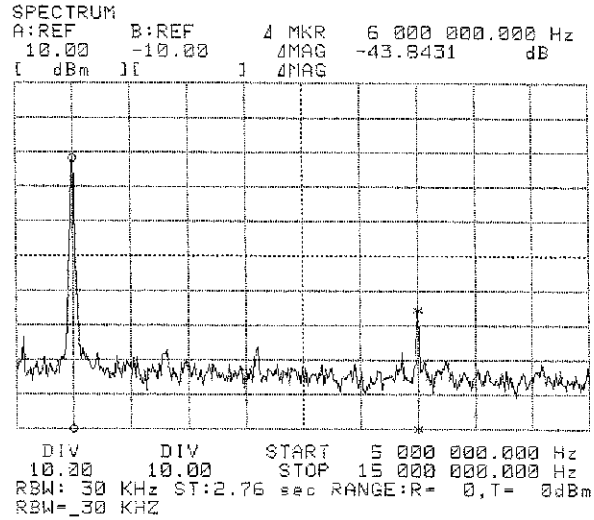
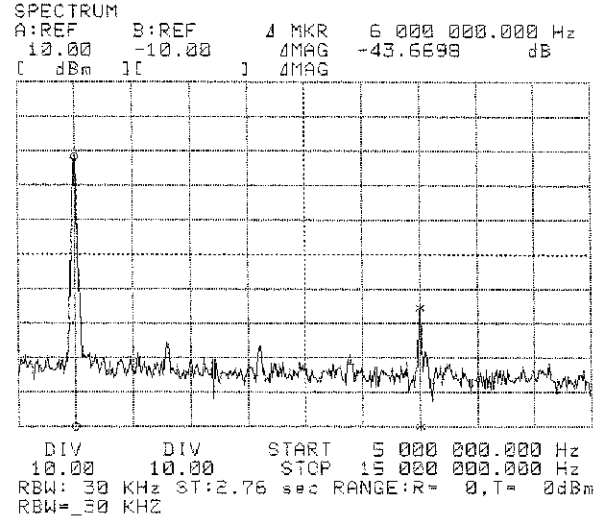

Figure 24 : $Z = 470\Omega//100\text{pF}$



CROSSTALK BETWEEN CHANNELS

H2LP → on the other channels (See Figure 25).

Measuring method : Example crosstalk of H2LP channel on H1LP

1. The frequency response of the gain of H1LP is measured → (G dB)

2. Then the input signal is supplied to H2LP, and the frequency response is measured at the output with H1LP remaining selected → (G_C dB)
3. (crosstalk)_{dB} is : (G dB) - (G_C dB)

Remark : Crosstalk can be measured with different value of input impedances R_{IN}

Figure 25

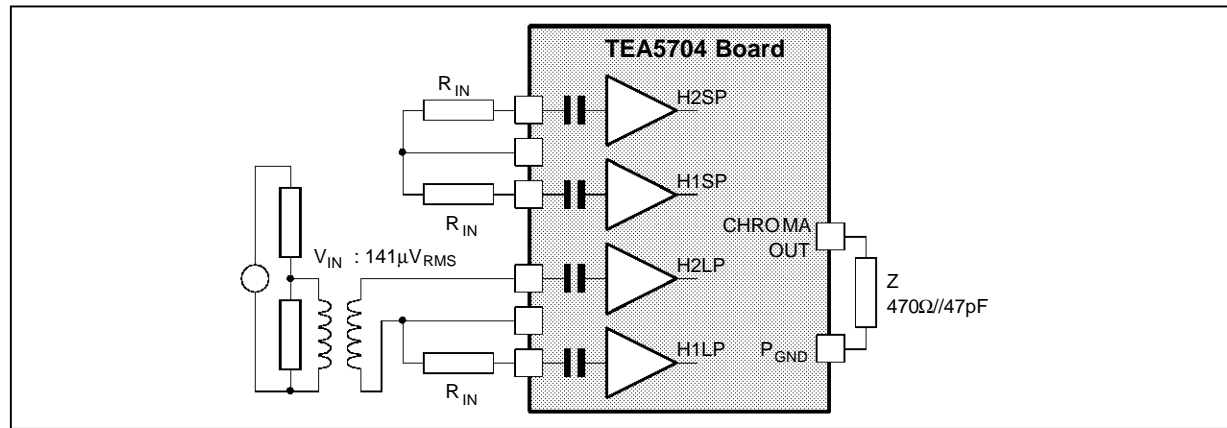

CROSSTALK OF H2LP ON THE OTHER CHANNELS

Figure 26 : H1LP - $R_{IN} = 0$

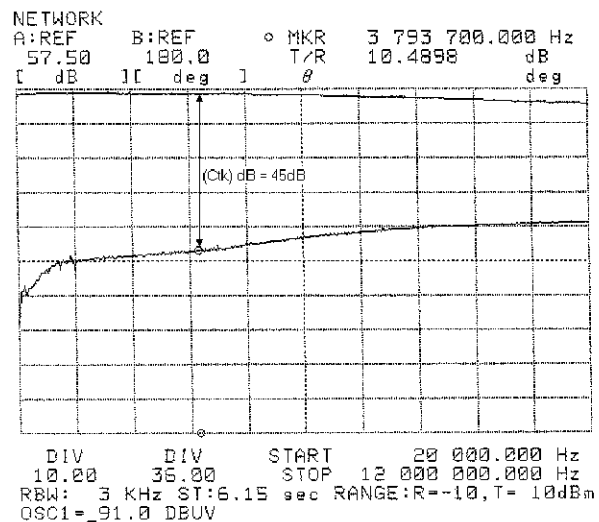

Figure 27 : H2SP - $R_{IN} = 0$

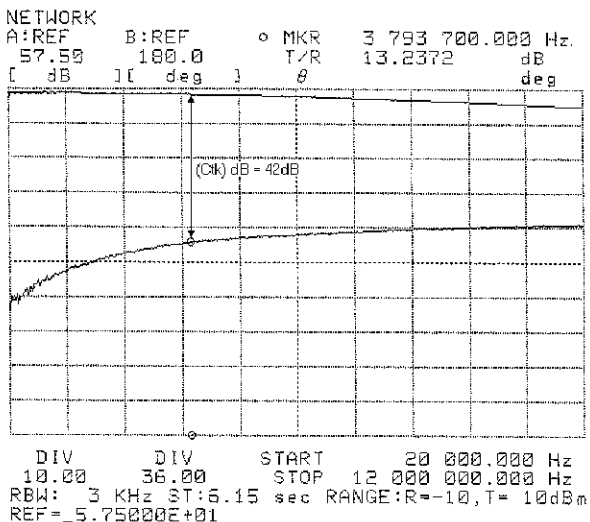

Figure 28 : H1SP - $R_{IN} = 0$

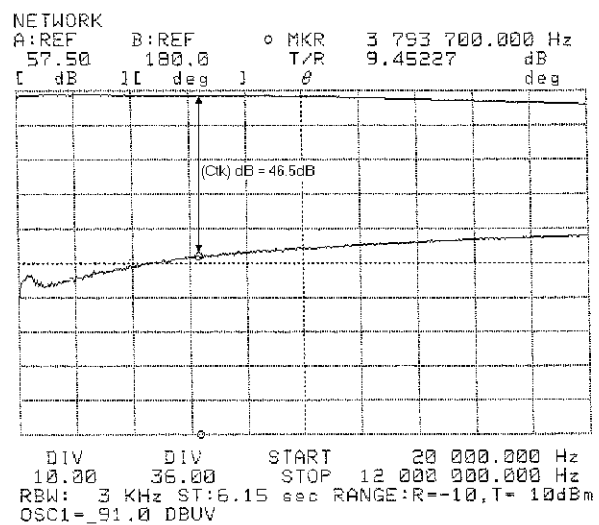
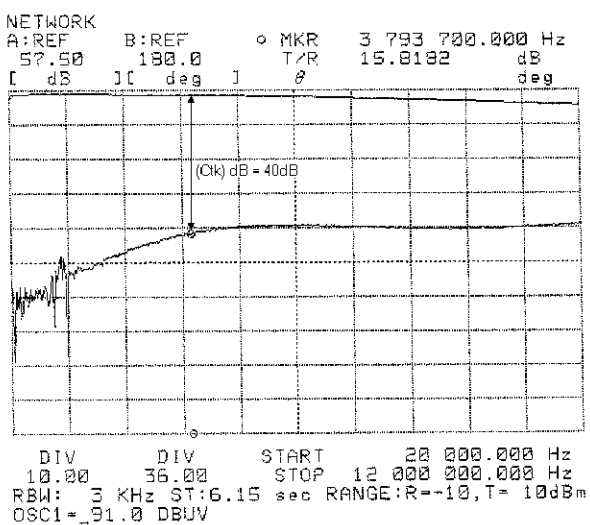

Figure 29 : H1LP - $R_{IN} = \infty$ (open)



TEA5704 - STV5712 DEMOBOARD

CROSSTALK OF H2LP ON THE OTHER CHANNELS (continued)

Figure 30 : H2SP - R_{IN} = ∞ (open)

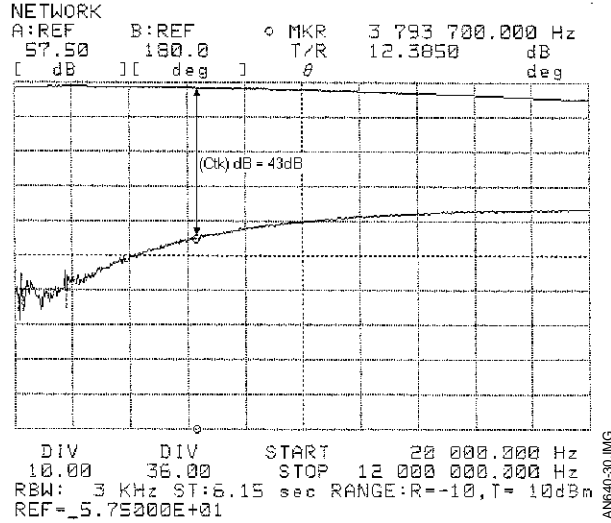
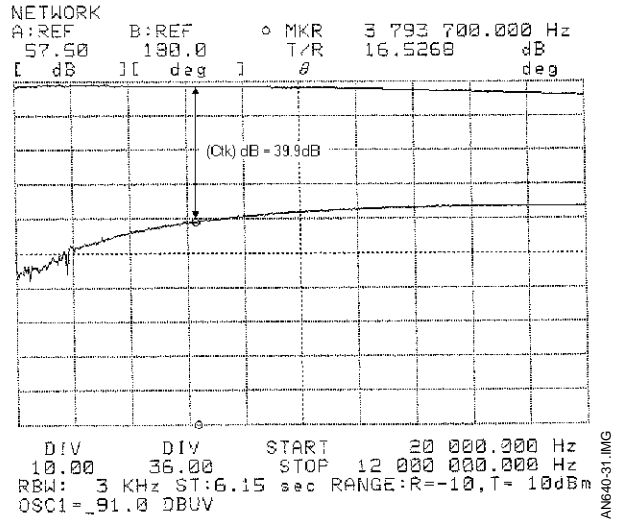

Figure 31 : H1SP - R_{IN} = ∞ (open)



EQUIVALENT INPUT VOLTAGE NOISE MEASUREMENT e_N

EQUIVALENT INPUT CURRENT NOISE MEASUREMENT i_N

- Input voltage noise : e_N (see Figure 32)

The output voltage (V_{OUT}) is measured with the input pin connected to the common point. In this way the input of the preamplifier is grounded in AC.

$$e_N = \frac{V_{OUT}}{G_V} \quad (G_V : \text{voltage gain of the channel})$$

- Input current noise : i_N

Same method but the input pin is floating.

$$i_N = \frac{1}{Z_{IN}} \cdot \frac{V_{OUT}}{G_V}$$

Z_{IN} : Preamplifier Input Impedance

Figure 32

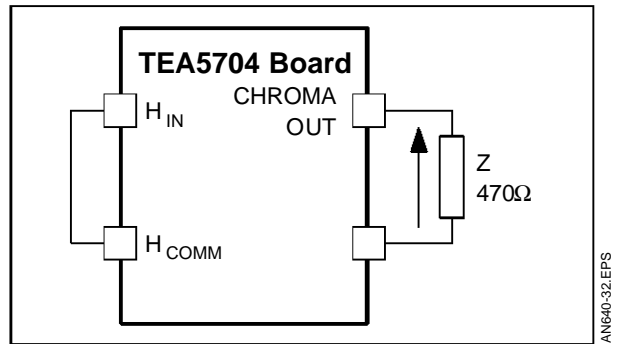

NOISE CHARACTERISTICS OF H2LP

Figure 33 : $e_N (e_N = \frac{V_{OUT}}{G_V}, G_V = 59.3dB)$
 $e_N = 0.58nV/\sqrt{Hz}$

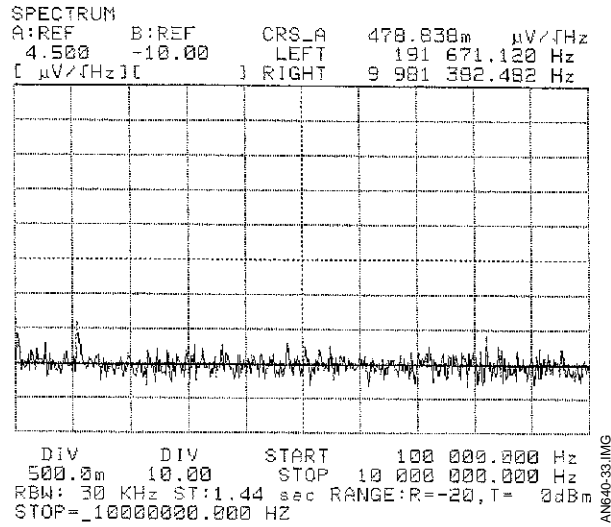
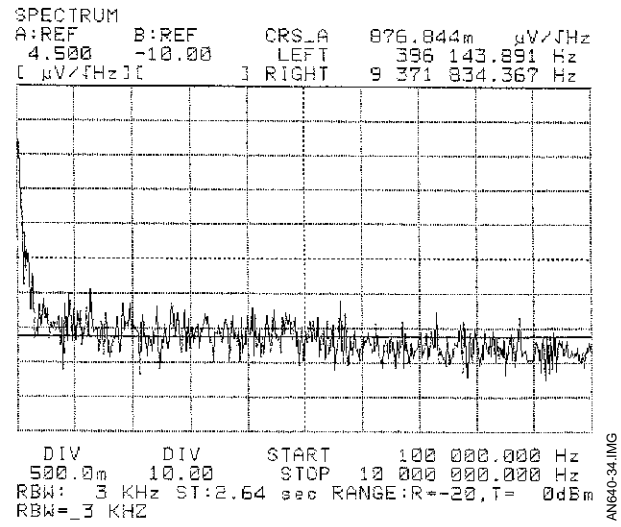

Figure 34 : $I_N (e_N = \frac{V_{OUT}}{G_V \cdot Z_{IN}} - Z_{IN} = 500\Omega)$
 $I_N = 1.88pA/\sqrt{Hz}$



V.1.b - TEA5704 Record Mode

BANDWIDTH AND HARMONIC 2 MEASURING CIRCUIT

Figure 35

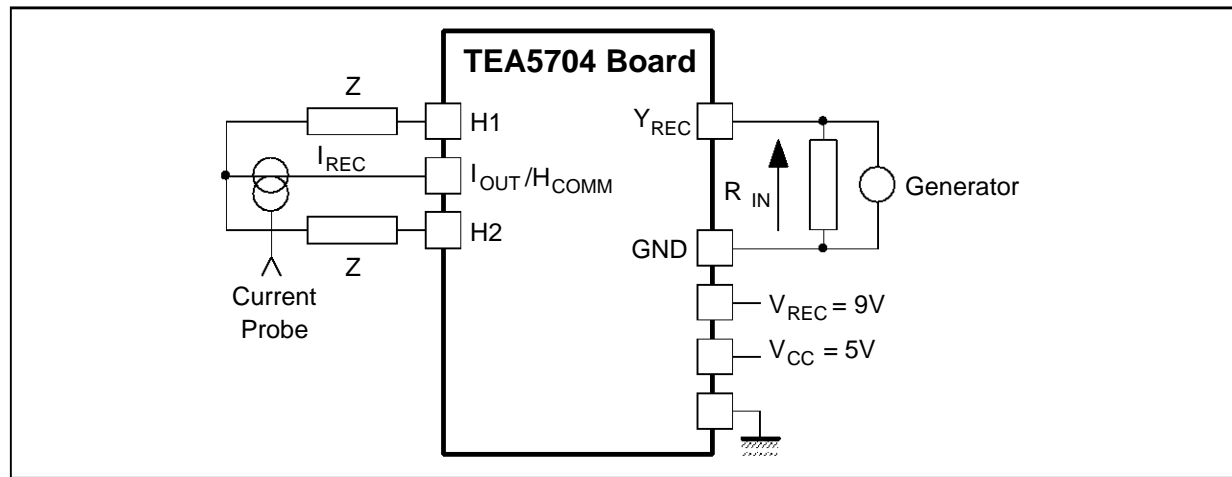

TEA5704 - STV5712 DEMOBOARD

BANDWIDTH : $\frac{I_{REC}}{V_{IN}}$ ($I_{REC} = 10\text{mA p-pk}$)

Figure 36 : SP Channel - Z = 100Ω

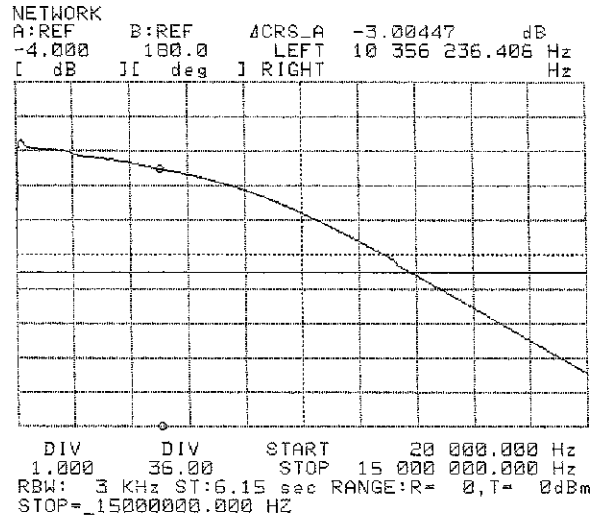
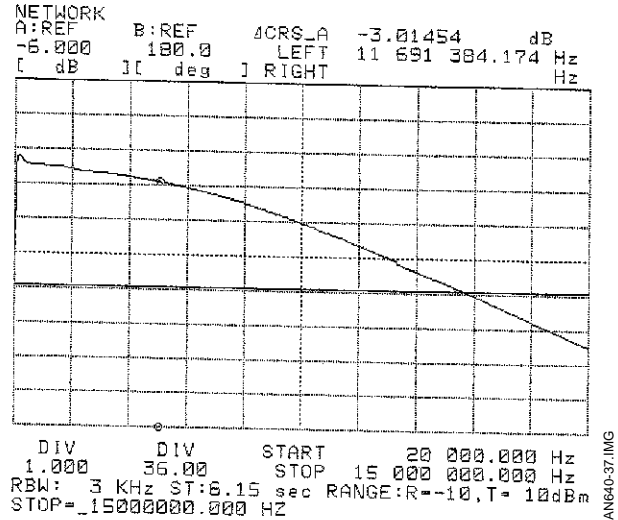

Figure 37 : LP Channel - Z = 100Ω



BANDWIDTH : $\frac{I_{REC}}{V_{IN}}$ ($I_{REC} = 60\text{mA p-pk}$)

Figure 38 : SP Channel - Z = 100Ω

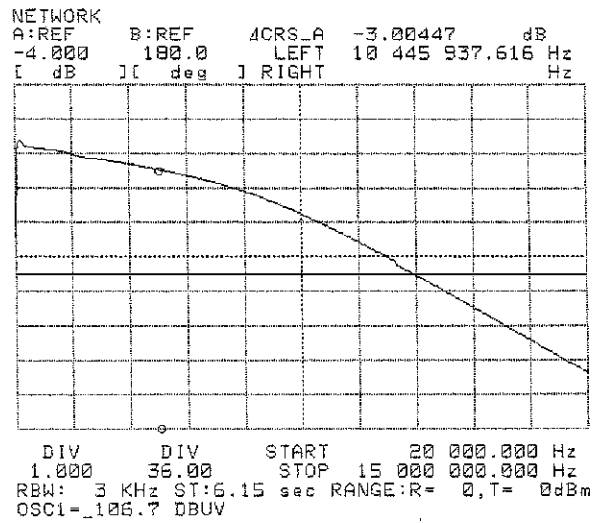
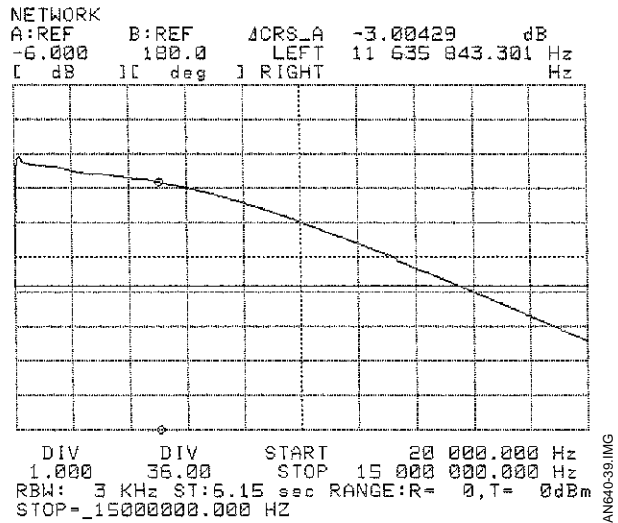

Figure 39 : LP Channel - Z = 100Ω



RECORD MODE - HARMONIC 2 ($I_{REC} = 20\text{mA p-pk}$, $f_{IN} = 3.8\text{MHz}$)

Figure 40 : SP Channel - $Z = 100\Omega$

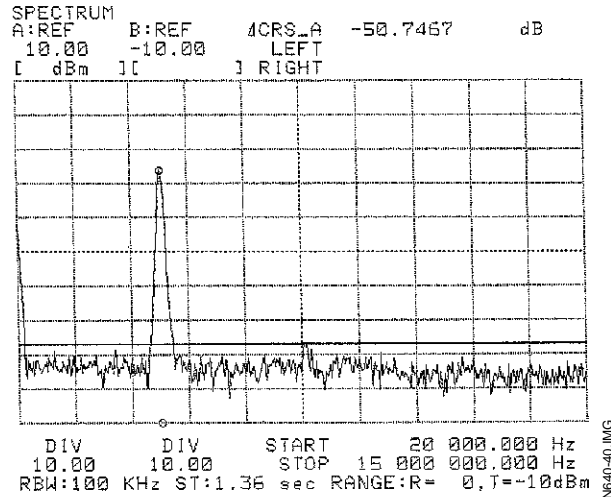
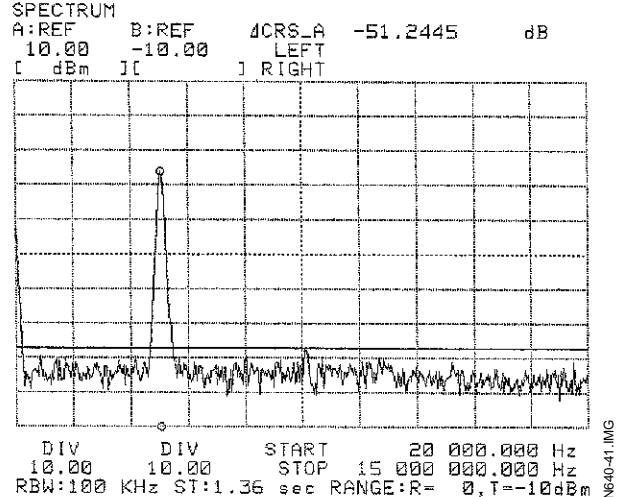

Figure 41 : LP Channel - $Z = 100\Omega$



RECORD MODE - HARMONIC 2 ($I_{REC} = 60\text{mA p-pk}$, $f_{IN} = 3.8\text{MHz}$)

Figure 42 : SP Channel - $Z = 100\Omega$

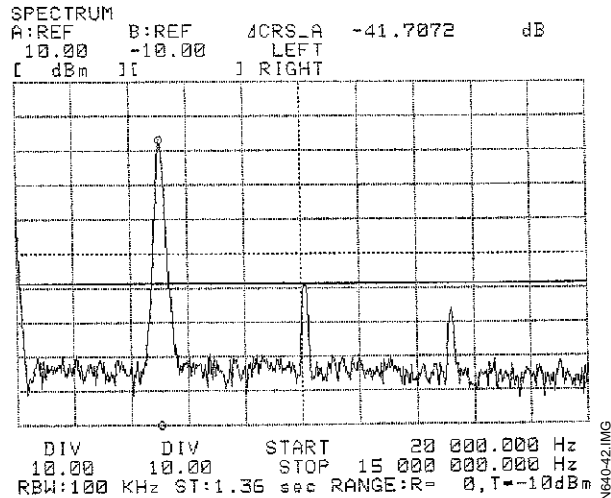
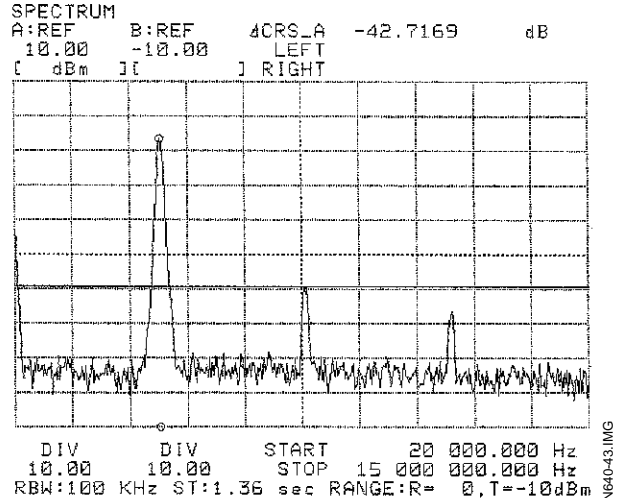

Figure 43 : LP Channel - $Z = 100\Omega$



TEA5704 - STV5712 DEMOBOARD

RECORD MODE - HARMONIC 2 ($F_{IN} = 6\text{MHz}$, $Z = 100\Omega$)

Figure 44 : $I_{REC} = 60\text{mA p-pk}$

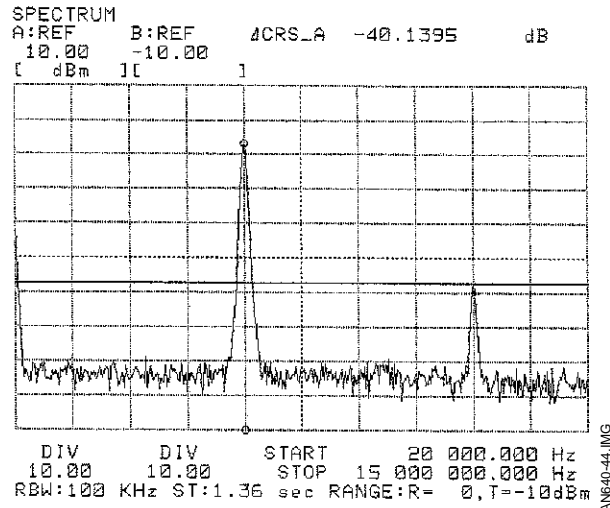
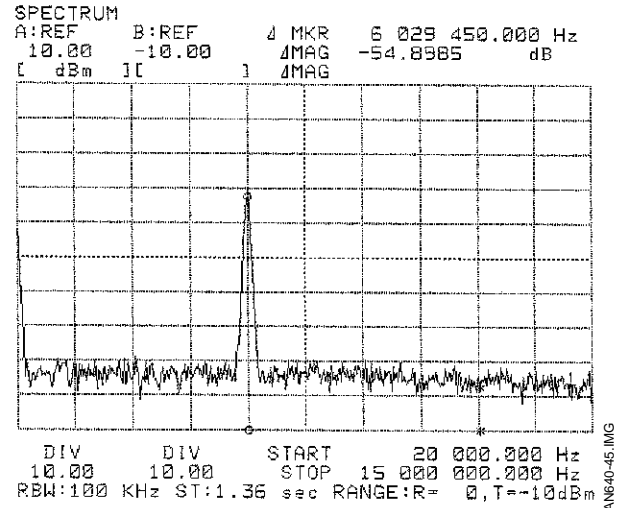

Figure 45 : $I_{REC} = 10\text{mA p-pk}$



RECORD MODE RESULTS VERSUS V_{REC} - HARMONIC 2 ($f_{IN} = 3.8\text{MHz}$, $I_{REC} = 60\text{mA p-pk}$, $Z = 0\Omega$)

Figure 46 : $V_{REC} = 2.5\text{V}$

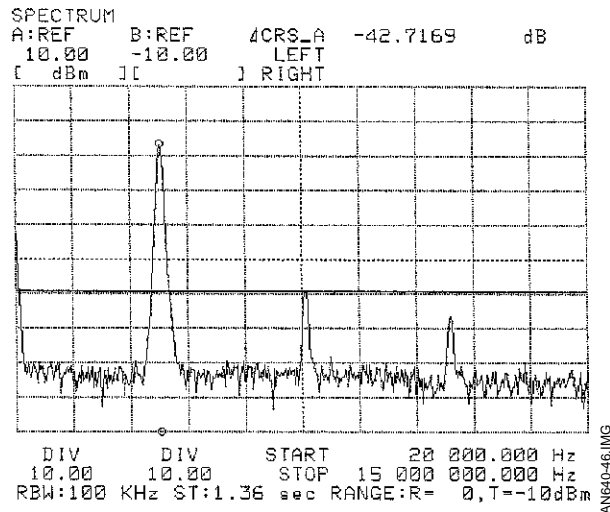
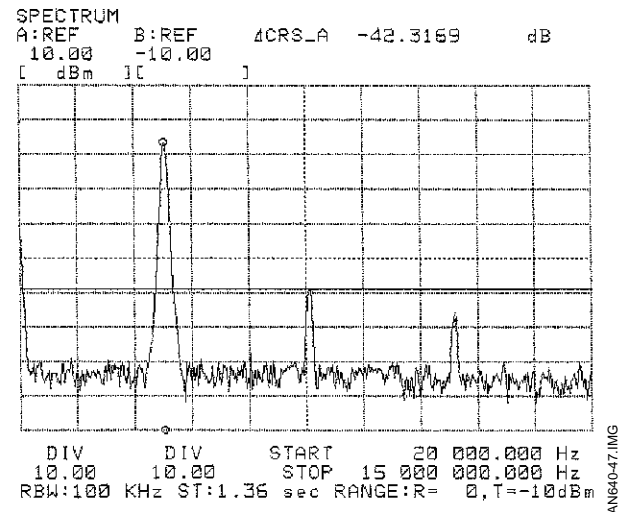

Figure 47 : $V_{REC} = 5\text{V}$



RECORD MODE RESULTS VERSUS V_{REC} - HARMONIC 2 ($f_{IN} = 3.8\text{MHz}$, $I_{REC} = 60\text{mA p-pk}$) (continued)

Figure 48 : $V_{REC} = 9\text{V}$

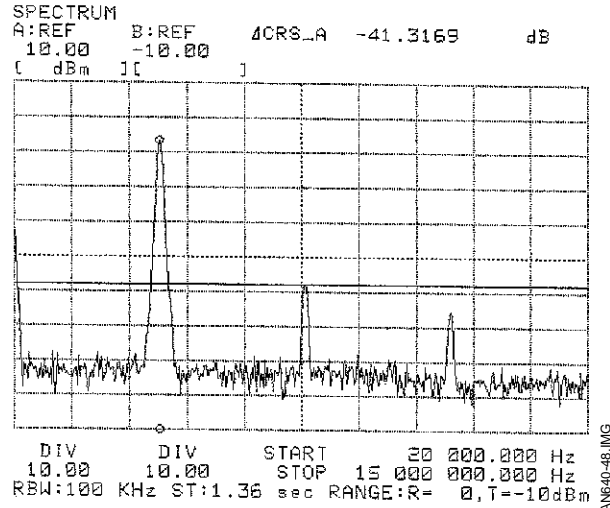
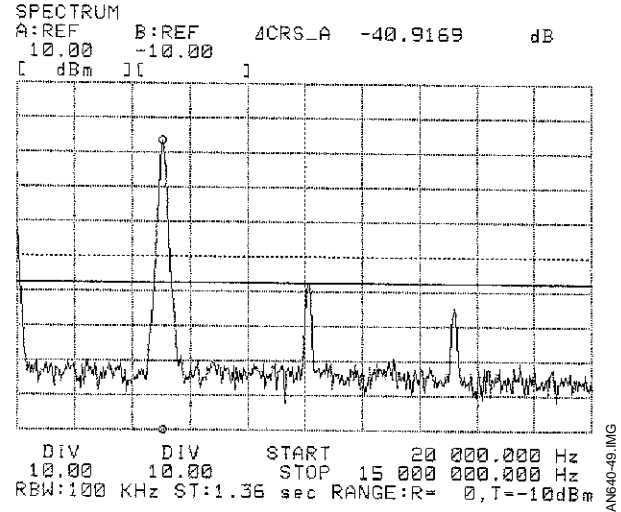

Figure 49 : $V_{REC} = 12\text{V}$



RECORD MODE RESULTS VERSUS V_{REC} - HARMONIC 2 ($f_{IN} = 6\text{MHz}$)

Figure 50 : $V_{REC} = 5\text{V}$, $I_{REC} = 10\text{mA p-pk}$

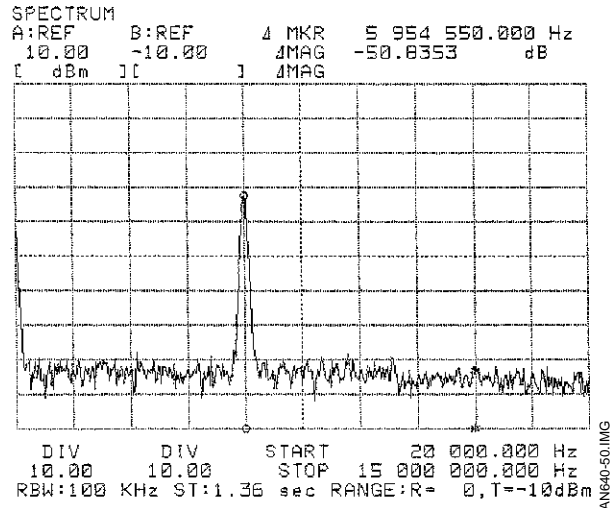
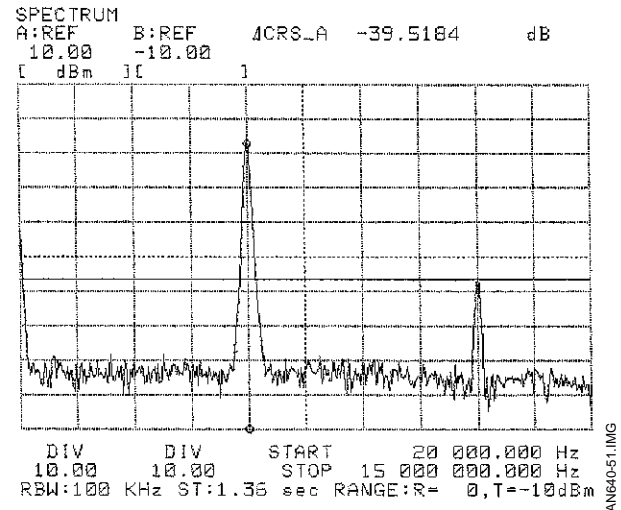

Figure 51 : $V_{REC} = 5\text{V}$, $I_{REC} = 60\text{mA p-pk}$



TEA5704 - STV5712 DEMOBOARD

RECORD MODE - BANDWIDTH VERSUS V_{REC}

Figure 52 : $I_{REC} = 20\text{mA p-pk}$

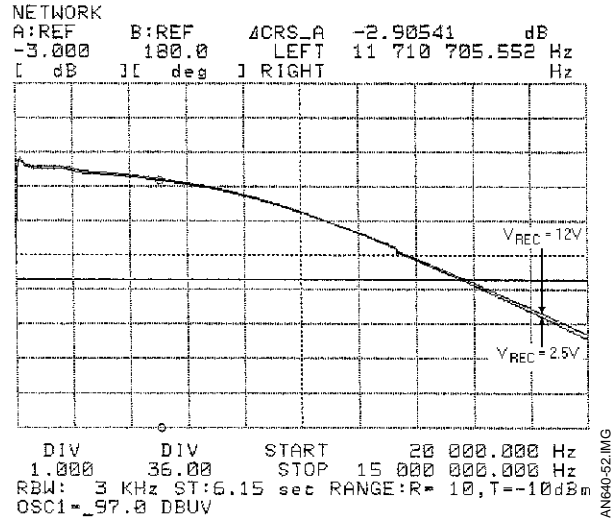

RECORD MODE - BANDWIDTH WITH DRUM ($I_{REC} = 20\text{ mA p-pk}$)

Figure 53 : SP Channel - Z = head

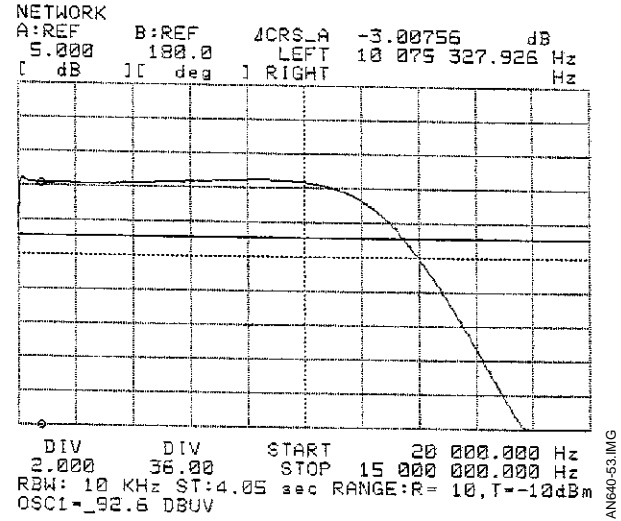

RECORD MODE - INTERMODULATION

Figure 54

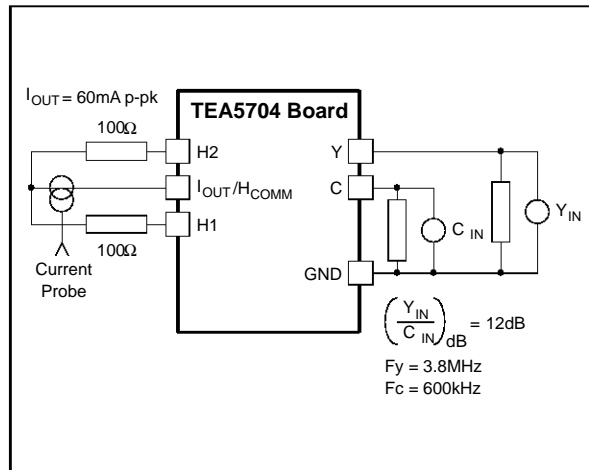
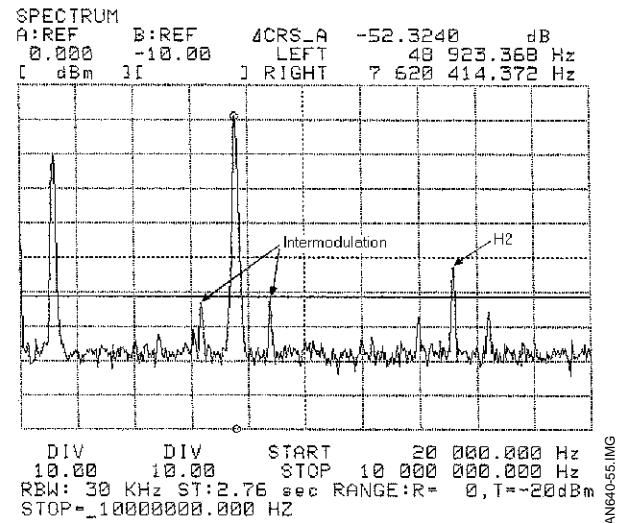

Figure 55 : SP Channel



V.1 - STV5712 Application

V.1.a - STV5712 Playback Mode

BANDWIDTH AND HARMONIC 2 MEASUREMENTS METHOD

For harmonic 2 measurement $f_{IN} = 1.6\text{MHz}$, $V_{IN} = 100\mu\text{Vp-pk}$

Figure 56

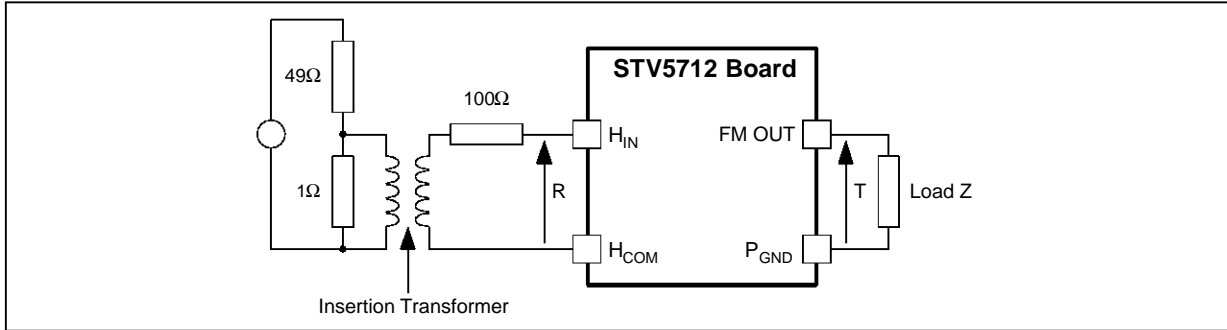

AN640-56.EPS

BANDWIDTH ($Z = 470\Omega//47\text{pF}$)

Figure 57 : H1

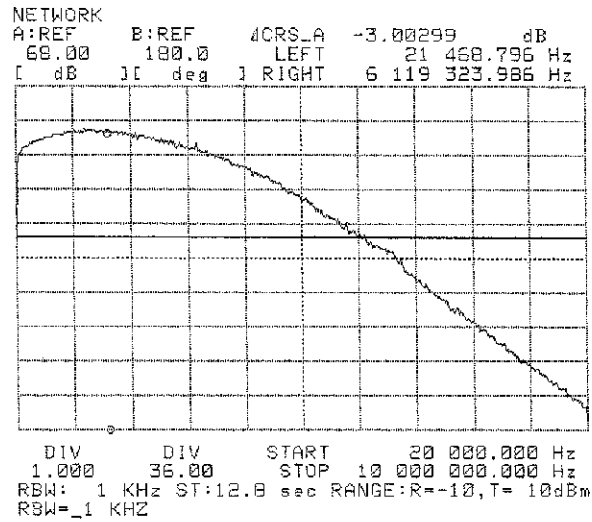

AN640-57.IMG

Figure 58 : H2

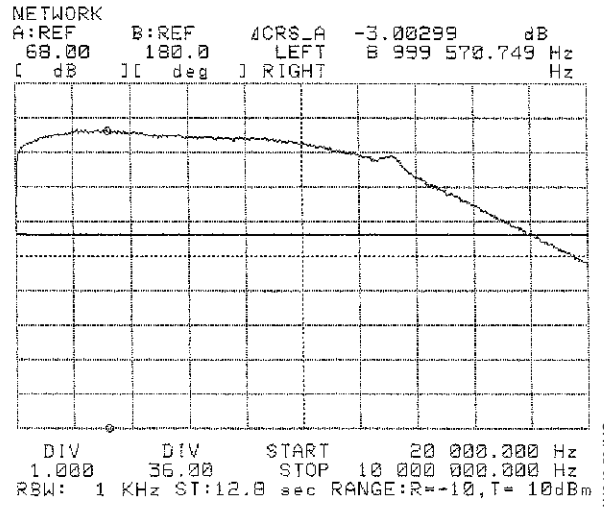

AN640-58.IMG

TEA5704 - STV5712 DEMOBOARD

HARMONIC 2 (Z = 470Ω//100pF)

Figure 59 : H1

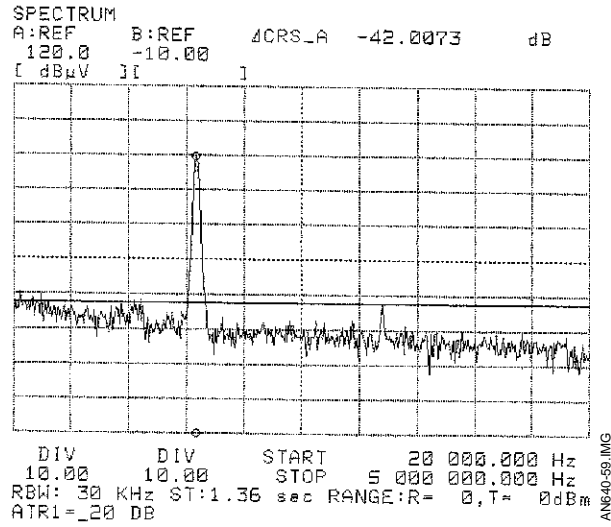
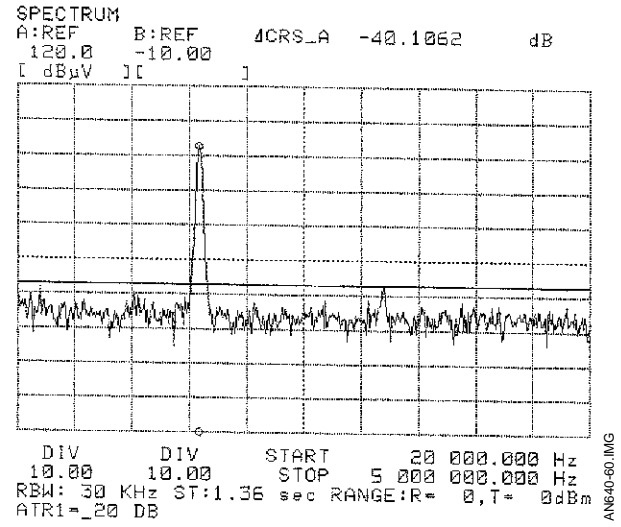

Figure 60 : H2



CROSSTALK MEASUREMENTS

See Figure 61.

Measuring method : Example crosstalk of H2 on H1 Channel

1. The frequency response of the gain of H1 is measured → (G dB)

2. Then the input signal is supplied to H2, and the frequency response is measured at the output with H1 remaining selected → (G_C dB)
3. (crosstalk)_{dB} is : (G dB) - (G_C dB)

Remark : Crosstalk has been measured in two cases R_{IN} = 0 and 10kΩ.

Figure 61

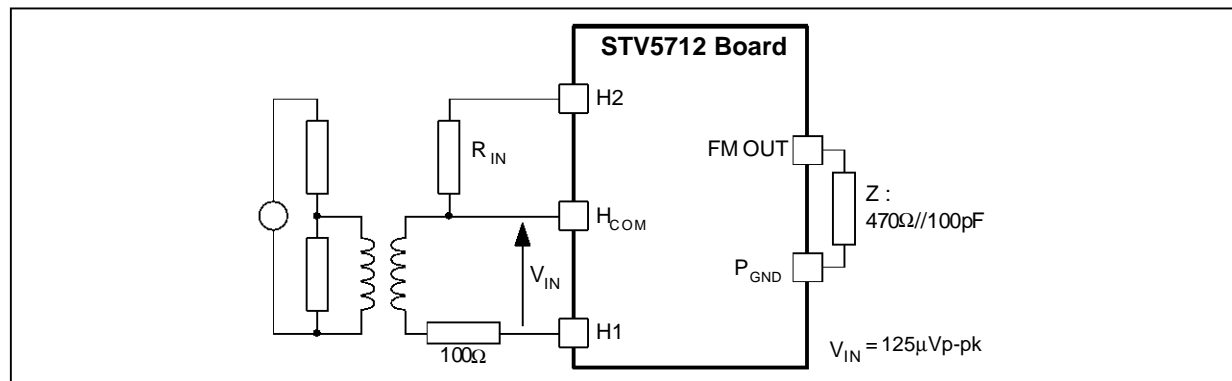

CROSSTALK INFLUENCE OF H2 ON H1 CHANNEL

Figure 62 : $R_{IN} = 10k\Omega$

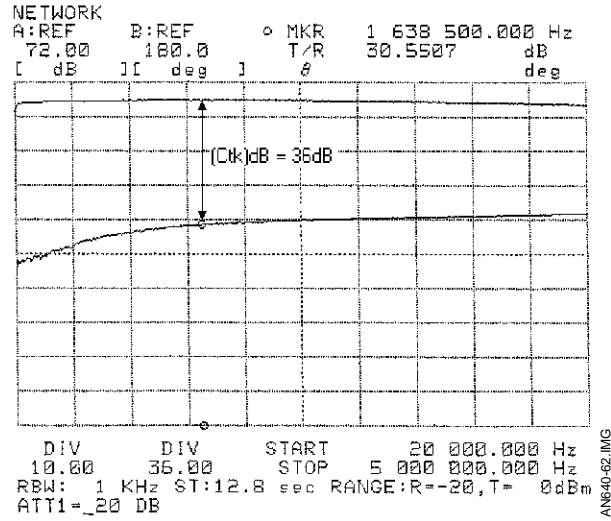
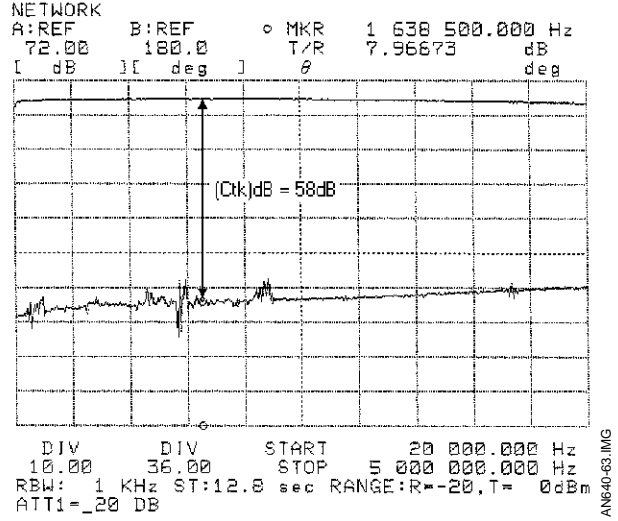

Figure 63 : $R_{IN} = 0\Omega$



CROSSTALK INFLUENCE OF H1 ON H2 CHANNEL

Figure 64 : $R_{IN} = 10k\Omega$

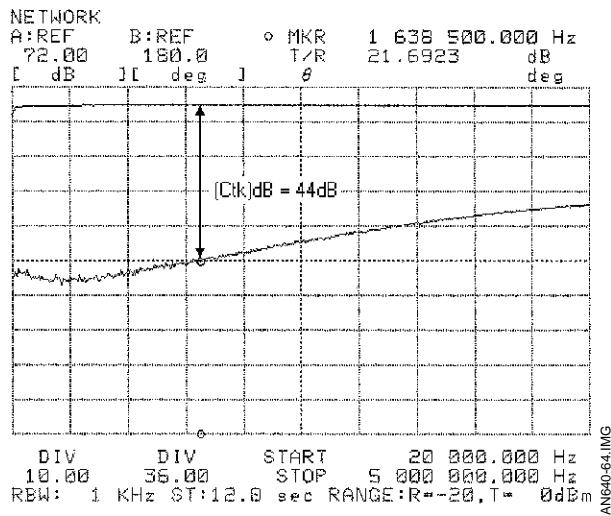
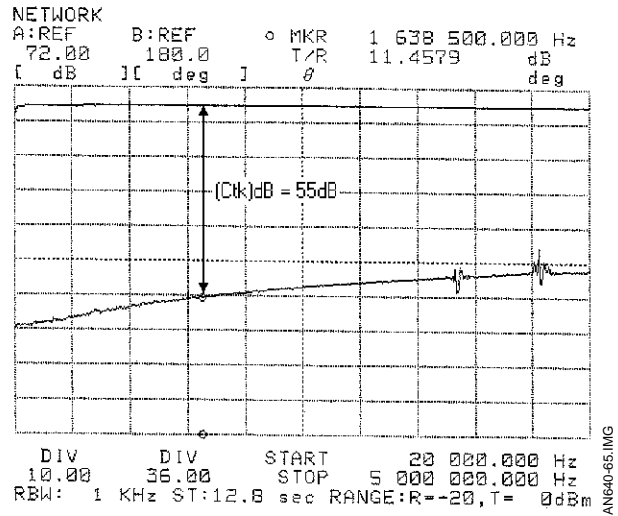

Figure 65 : $R_{IN} = 0\Omega$



TEA5704 - STV5712 DEMOBOARD

V.1.b - STV5712 Record Mode

BANDWIDTH AND HARMONIC 2 MESURING CIRCUIT

Figure 66

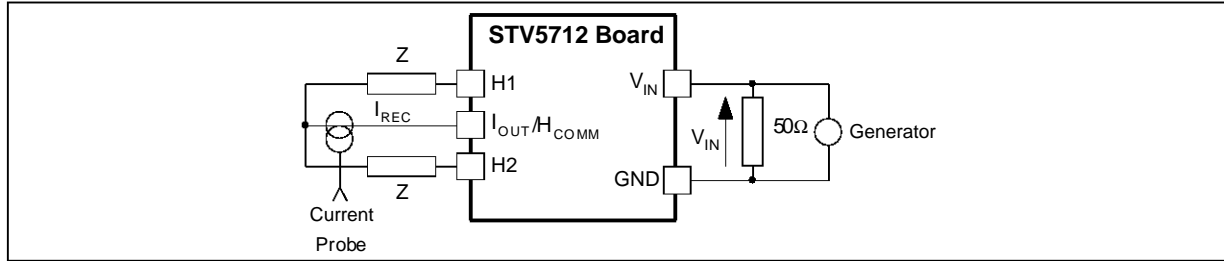

RECORD MODE - HARMONIC 2 (Z = 0Ω)

Figure 67 : I_REC = 60mA p-pk

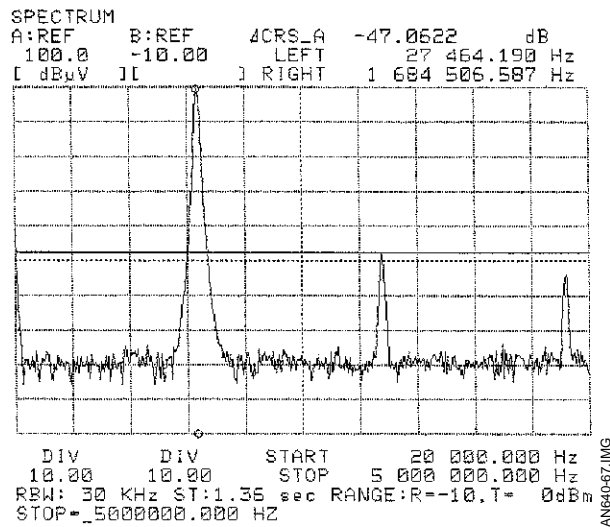
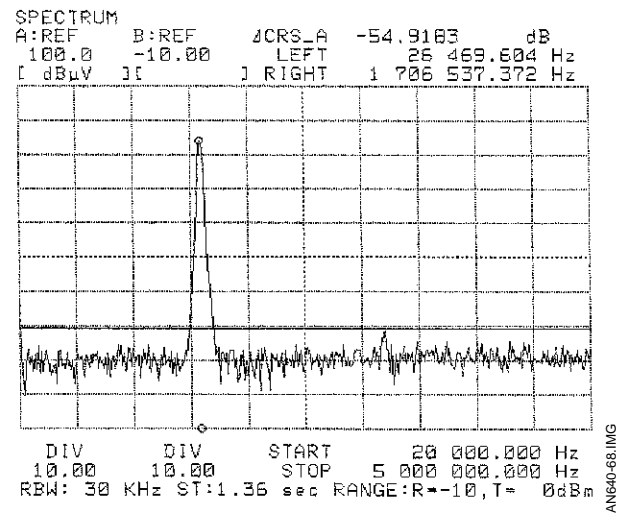

Figure 68 : I_REC = 10mA p-pk



$$\text{BANDWIDTH} : \frac{I_{REC}}{V_{IN}}$$

Figure 69 : Z = 15Ω, I_REC = 60mA p-pk

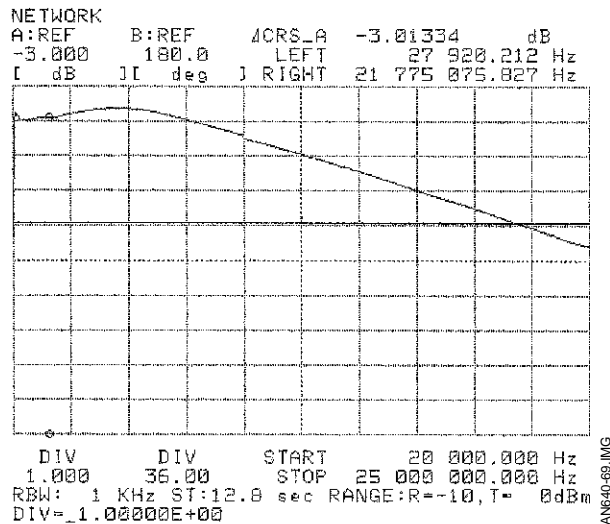
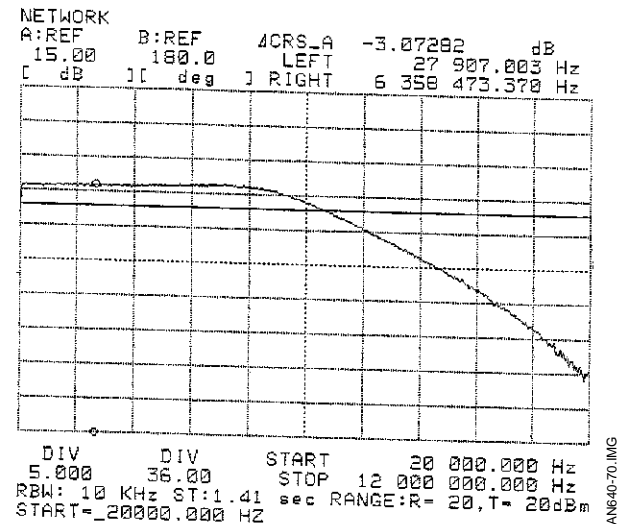

Figure 70 : Z = VTR drum, I_REC = 20mA p-pk (R105 = 330Ω in the damping circuit)



Information furnished is believed to be accurate and reliable. However, SGS-THOMSON Microelectronics assumes no responsibility for the consequences of use of such information nor for any infringement of patents or other rights of third parties which may result from its use. No licence is granted by implication or otherwise under any patent or patent rights of SGS-THOMSON Microelectronics. Specifications mentioned in this publication are subject to change without notice. This publication supersedes and replaces all information previously supplied. SGS-THOMSON Microelectronics products are not authorized for use as critical components in life support devices or systems without express written approval of SGS-THOMSON Microelectronics.

© 1994 SGS-THOMSON Microelectronics - All Rights Reserved

Purchase of I²C Components of SGS-THOMSON Microelectronics, conveys a license under the Philips I²C Patent. Rights to use these components in a I²C system, is granted provided that the system conforms to the I²C Standard Specifications as defined by Philips.

SGS-THOMSON Microelectronics GROUP OF COMPANIES

Australia - Brazil - China - France - Germany - Hong Kong - Italy - Japan - Korea - Malaysia - Malta - Morocco
The Netherlands - Singapore - Spain - Sweden - Switzerland - Taiwan - Thailand - United Kingdom - U.S.A.