

VERTICAL DEFLECTION BOOSTER

- POWER AMPLIFIER
- THERMAL PROTECTION
- OUTPUT CURRENT UP TO 3.0A_{PP}
- FLYBACK VOLTAGE UP TO 70V (on Pin 5)
- SUITABLE FOR DC COUPLING APPLICATION
- EXTERNAL FLYBACK SUPPLY

DESCRIPTION

Designed for monitors and high performance TVs, the TDA8177F vertical deflection booster can handle flyback voltage up to 70V. More than this it is possible to have a flyback voltage which is more than the double of the supply (Pin 2). This allows to decrease the power consumption or to decrease the flyback time for a given supply voltage.

The TDA8177F operates with supplies up to 35V and provides up to 3A_{pp} output current to drive the yoke.

The TDA8177F is offered in HEPTAWATT package.

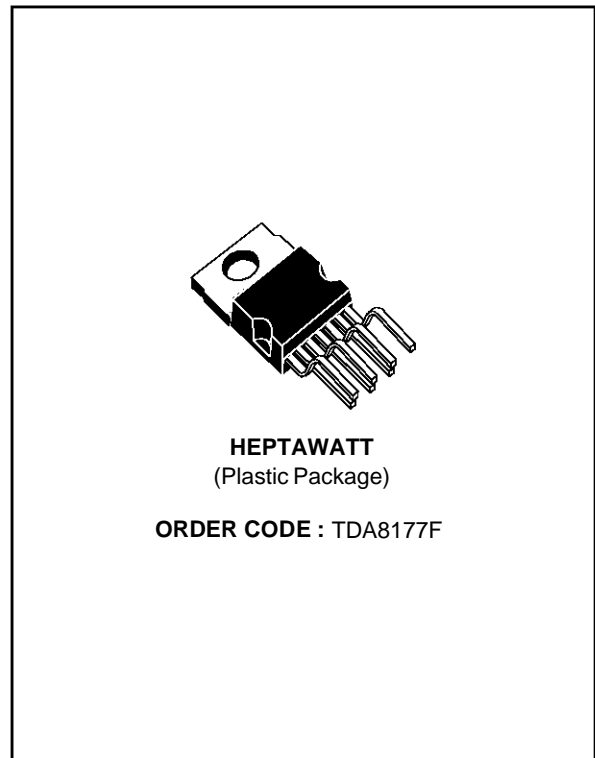

PIN CONNECTIONS

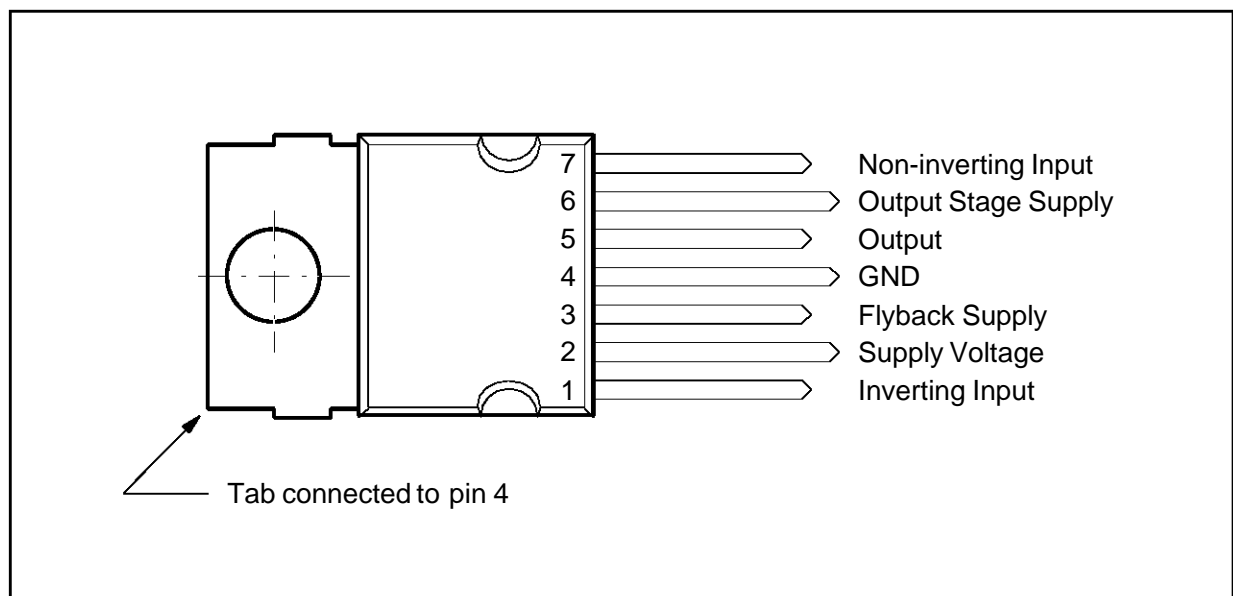

8177F-01E/PS

BLOCK DIAGRAM

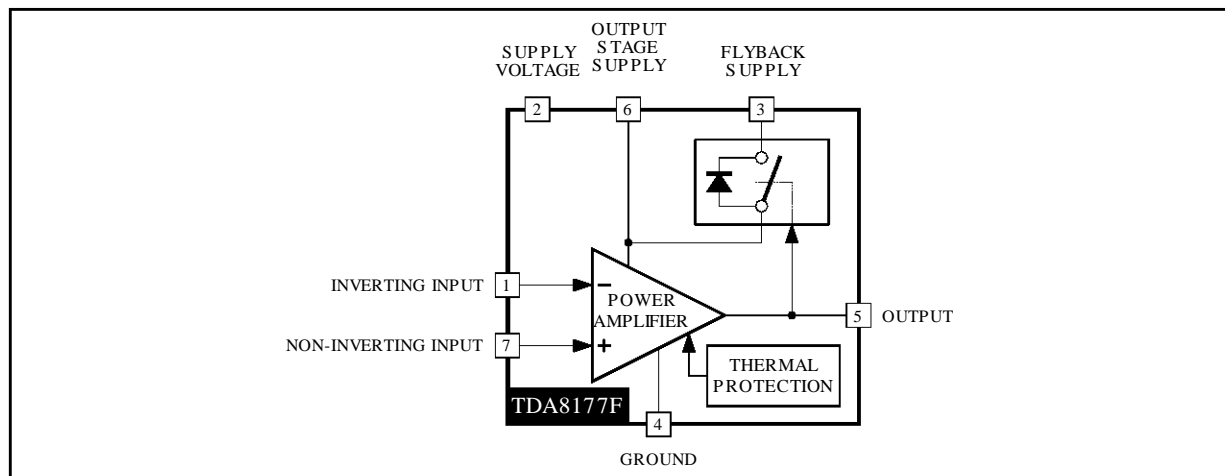

8177F-02.EPS

ABSOLUTE MAXIMUM RATINGS

Symbol	Parameter	Value	Unit
V _S	Supply Voltage (Pin 2) (see note 1)	40	V
V ₆	Flyback Peak Voltage (Pin 6) (see note 1)	75	V
V ₁ , V ₇	Amplifier Input Voltage (Pins 1-7) (see note 1)	- 0.3, + V _S	V
I _O	Maximum Output Peak Current (see notes 2 and 3)	2.5	A
I ₃	Maximum Sink Current (t < 1ms)	2.5	A
I ₃	Maximum Source Current (t < 1ms) (in the diode, see Block Diagram)	2.5	A
V _{ESD1} V _{ESD2}	ESD Susceptibility Tool Model (see note 4) Human Model (see note 5)	300 2	V kV
V ₃ - V ₂	Voltage Difference between Flyback Supply and Supply Voltage	50	V
V ₃ , V ₅ , V ₆	Min. Voltage (see note 1)	-0.4	V
T _{oper}	Operating Ambient Temperature	- 20, + 75	°C
T _{stg}	Storage Temperature	- 40, + 150	°C
T _j	Junction Temperature	+150	°C

8177F-01.TBL

- Notes :**
1. Versus Pin 4.
 2. The output current can reach 4A peak for t ≤ 10µs (up to 200Hz).
 3. Provided SOAR is respected (see Figures 1 and 2).
 4. Equivalent to discharging a 200pF capacitor through a 0Ω series resistor.
 5. Equivalent to discharging a 150pF capacitor through a 1.5kΩ series resistor.

THERMAL DATA

Symbol	Parameter	Value	Unit
R _{th(j-c)}	Junction-case Thermal Resistance Max.	3	°C/W
T _t	Temperature for Thermal Shutdown	150	°C
ΔT _t	Hysteresis on T _t	10	°C
T _{jr}	Recommended Max. Junction Temperature	120	°C

8177F-02.TBL

ELECTRICAL CHARACTERISTICS

($V_S = 35V$, $T_A = 25^\circ C$, unless otherwise specified)

Symbol	Parameter	Test Conditions	Min.	Typ.	Max.	Unit
V_S	Operating Supply Voltage Range		10		35	V
V_{3M}	Operating Flyback Supply Voltage		V_S		70	V
I_2	Pin 2 Quiescent Current	$I_3 = 0, I_5 = 0$		10	20	mA
I_6	Pin 6 Quiescent Current	$I_3 = 0, I_5 = 0$		25	35	mA
I_O	Max. Scanning Peak Output Current				1.5	A
I_1	Amplifier Bias Current	$V_1 = 20V, V_7 = 21V$		- 0.4	- 2	μA
I_7	Amplifier Bias Current	$V_1 = 21V, V_7 = 20V$		- 0.4	- 2	μA
V_{IO}	Offset Voltage			0	7	mV
$\Delta V_{IO}/dt$	Offset Drift versus Temperature			- 10		$\mu V/^\circ C$
GV	Voltage Gain		80			dB
V_{5L}	Output Saturation Voltage to GND (Pin 4)	$I_5 = 1.5A$		1.0	2	V
V_{5H}	Output Saturation Voltage to Supply (Pin 6)	$I_5 = - 1.5A$		1.7	2.5	V
V_{D5-6}	Diode Forward Voltage between Pins 5-6	$I_5 = 1.5A$		1.5	2.1	V
V_{D3-6}	Diode Forward Voltage between Pins 3-6	$I_3 = 1.5A$		2.3	3	V
V_{3-6}	Voltage Drop between Pins 3-6 (2nd part of flyback)	$I_3 = - 1.5A$		4	5	V

8177F-03.TBL

APPLICATION CIRCUITS

AC COUPLING

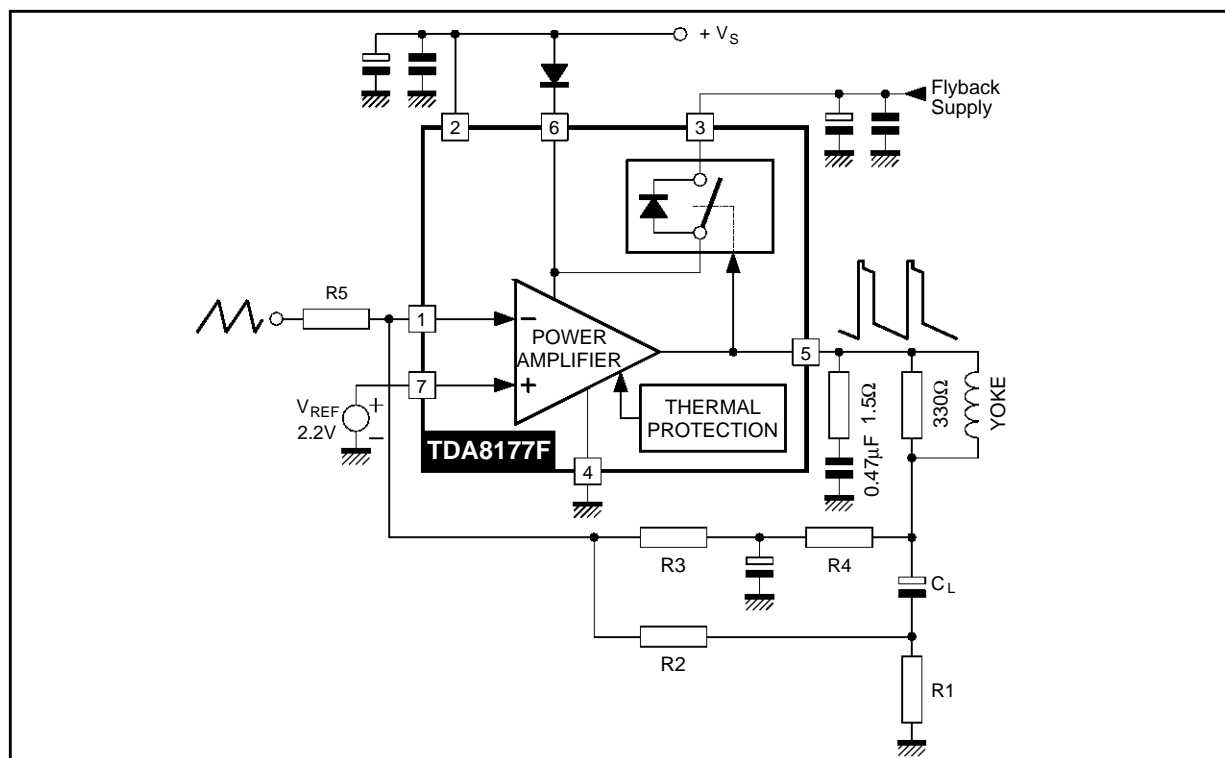

8177F-03.EPS

APPLICATION CIRCUITS (continued)
DC COUPLING

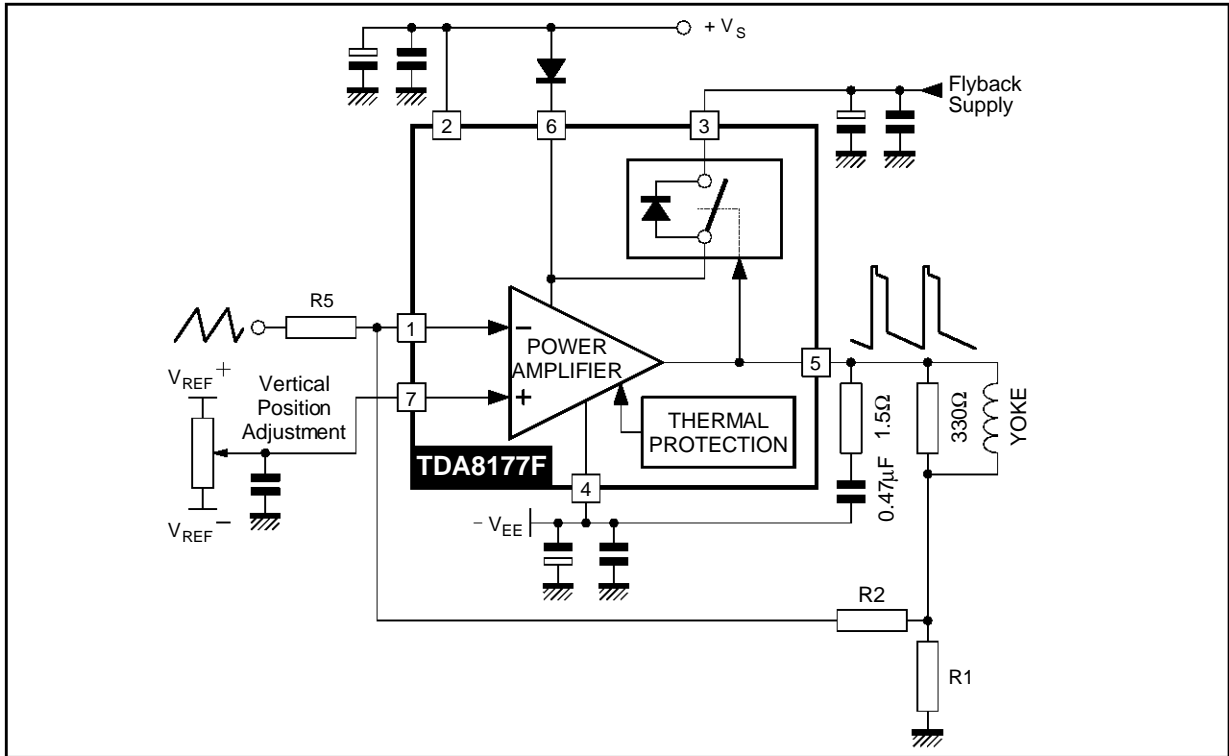

8177F-04.EPS

Figure 1 : Output Transistors SOA (for secondary breakdown)

Figure 2 : Secondary Breakdown Temperature Derating Curve (ISB = secondary breakdown cur-

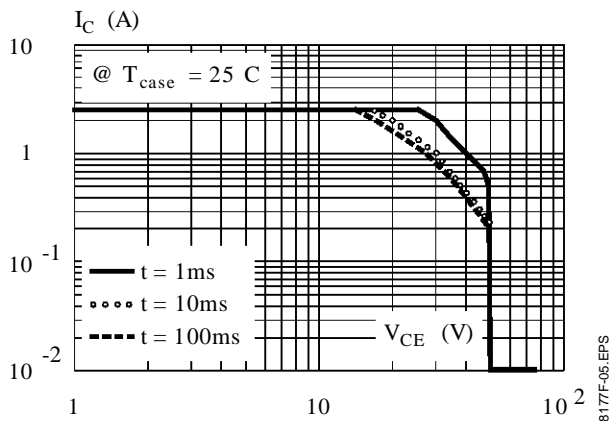

8177F-05.EPS

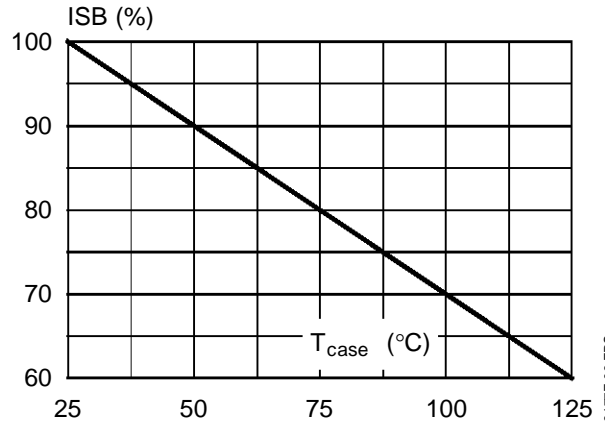

8177F-06.EPS

PACKAGE MECHANICAL DATA : 7 PINS - PLASTIC HEPTAWAT

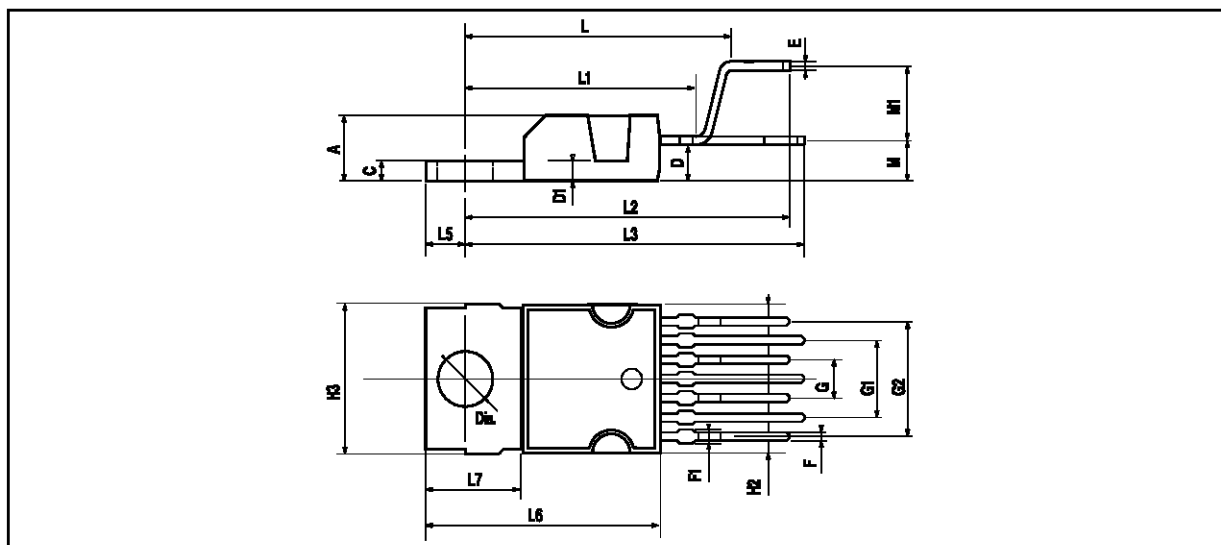

PM-HEPTV.EPS

Dimensions	Millimeters			Inches		
	Min.	Typ.	Max.	Min.	Typ.	Max.
A			4.8			0.189
C			1.37			0.054
D	2.4		2.8	0.094		0.110
D1	1.2		1.35	0.047		0.053
E	0.35		0.55	0.014		0.022
F	0.6		0.8	0.024		0.031
F1			0.9			0.035
G	2.41	2.54	2.67	0.095	0.100	0.105
G1	4.91	5.08	5.21	0.193	0.200	0.205
G2	7.49	7.62	7.8	0.295	0.300	0.307
H2			10.4			0.409
H3	10.05		10.4	0.396		0.409
L		16.97			0.668	
L1		14.92			0.587	
L2		21.54			0.848	
L3		22.62			0.891	
L5	2.6		3	0.102		0.118
L6	15.1		15.8	0.594		0.622
L7	6		6.6	0.236		0.260
M		2.8			0.110	
M1		5.08			0.200	
Dia.	3.65		3.85	0.144		0.152

HEPTV.TBL

Information furnished is believed to be accurate and reliable. However, SGS-THOMSON Microelectronics assumes no responsibility for the consequences of use of such information nor for any infringement of patents or other rights of third parties which may result from its use. No licence is granted by implication or otherwise under any patent or patent rights of SGS-THOMSON Microelectronics. Specifications mentioned in this publication are subject to change without notice. This publication supersedes and replaces all information previously supplied. SGS-THOMSON Microelectronics products are not authorized for use as critical components in life support devices or systems without express written approval of SGS-THOMSON Microelectronics.

© 1997 SGS-THOMSON Microelectronics - All Rights Reserved

Purchase of I²C Components of SGS-THOMSON Microelectronics, conveys a license under the Philips I²C Patent. Rights to use these components in a I²C system, is granted provided that the system conforms to the I²C Standard Specifications as defined by Philips.

SGS-THOMSON Microelectronics GROUP OF COMPANIES

Australia - Brazil - Canada - China - France - Germany - Hong Kong - Italy - Japan - Korea - Malaysia - Malta - Morocco
The Netherlands - Singapore - Spain - Sweden - Switzerland - Taiwan - Thailand - United Kingdom - U.S.A.