

TOSHIBA BIPOLAR DIGITAL INTEGRATED CIRCUIT SILICON MONOLITHIC

TD62318BP, TD62318BF

4CH LOW INPUT ACTIVE HIGH-CURRENT DARLINGTON SINK DRIVER

The TD62318BP and TD62318BF are non-inverting transistor array which are comprised of four NPN darlington output stages and PNP input stages.

This device is low level input active driver and are suitable for operation with TTL, 5 V CMOS and 5 V Microprocessor which have sink current output drivers.

Applications include relay, hammer, lamp and stepping motor drivers.

FEATURES

- Two VCC Terminals VCC1, VCC2 (Separated)
- Package Type BP: DIP-16 pin
BF: HSOP-16 pin
- High Sustaining Voltage Output : $V_{CE(SUS)} = 80\text{ V (Min.)}$
- Output Current (Single Output) : $I_{OUT} = 700\text{ mA / ch (Max.)}$
- Output Clamp Diodes
- Input Compatible with TTL and 5 V CMOS
- GND and SUB Terminal = Heat Sink
- Low Level Active Input
- Standard Supply Voltage

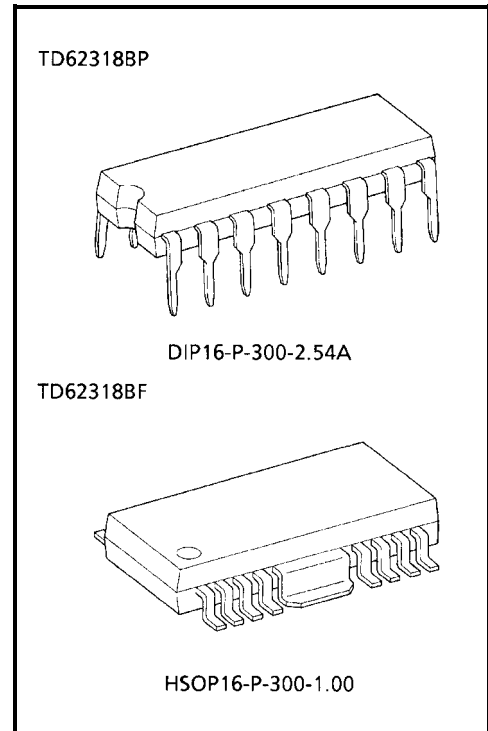

Weight

DIP16-P-300-2.54A : 1.11 g (Typ.)

HSOP16-P-300-1.00 : 0.50 g (Typ.)

PIN CONNECTION (TOP VIEW)

TD62318BP

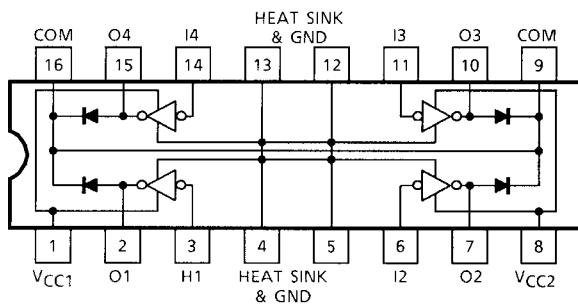

TD62318BF

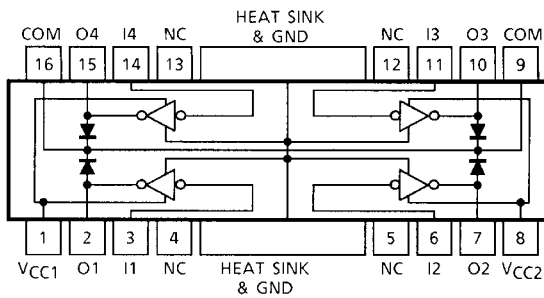

SCHEMATICS (EACH DRIVER)

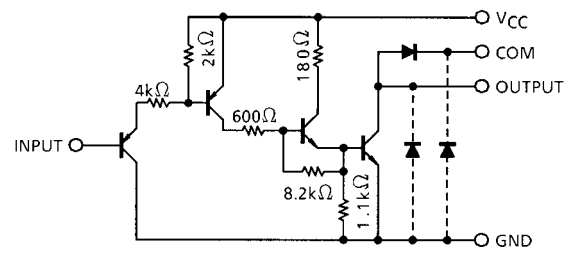

Note: The input and output parasitic diode cannot be used as clamp diode.

MAXIMUM RATINGS (Ta = 25°C)

CHARACTERISTIC	SYMBOL	RATING	UNIT	
Supply Voltage	V _{CC}	-0.5~17	V	
Output Sustaining Voltage	V _{CE (SUS)}	-0.5~80	V	
Output Current	I _{OUT}	700	mA / ch	
Input Current	I _{IN}	-10	mA	
Input Voltage	V _{IN}	-0.5~17	V	
Clamp Diode Reverse Voltage	V _R	80	V	
Clamp Diode Forward Current	I _F	700	mA	
Power Dissipation	BP	P _D	1.47 / 2.7 (Note 1)	W
	BF		0.9 / 1.4 (Note 2)	
Operating Temperature	T _{opr}	-40~85	°C	
Storage Temperature	T _{stg}	-55~150	°C	

Note 1: On Glass Epoxy PCB (50 × 50 × 1.6 mm Cu 50%)

Note 2: On Glass Epoxy PCB (60 × 30 × 1.6 mm Cu 30%)

RECOMMENDED OPERATING CONDITIONS (Ta = -40~85°C)

CHARACTERISTIC		SYMBOL	CONDITION	MIN	TYP.	MAX	UNIT
Supply Voltage		V _{CC}		4.5	—	5.5	V
Output Sustaining Voltage		V _{CE (SUS)}		0	—	50	V
Output Current	BP (Note 1)	I _{OUT}	DC 1 circuit, Ta = 25°C	0	—	570	mA / ch
			T _{pw} = 25 ms 4 circuits T _j = 120°C Ta = 85°C	Duty = 10%	0	—	
	Duty = 50%			0	—	330	
	BP (Note 2)		Duty = 10%	0	—	570	
Duty = 50%		0	—	100			
Input Voltage		V _{IN}		0	—	15	V
		Output On	V _{IN (ON)}	0	—	V _{CC} -3.6	V
		Output Off	V _{IN (OFF)}	V _{CC} -3.6	—	5.5	
Clamp Diode Reverse Voltage		V _R		—	—	80	V
Clamp Diode Forward Current		I _F		—	—	700	mA
Power Dissipation	BP	P _D	Ta = 85°C (Note 1)	—	—	1.4	W
	BF		Ta = 85°C (Note 2)	—	—	0.7	

Note 1: On Glass Epoxy PCB (50 × 50 × 1.6 mm Cu 50%)

Note 2: On Glass Epoxy PCB (60 × 30 × 1.6 mm Cu 30%)

ELECTRICAL CHARACTERISTICS (Ta = 25°C)

CHARACTERISTIC		SYMBOL	TEST CIR-CUIT	TEST CONDITION	MIN	TYP.	MAX	UNIT
Input Voltage	"H" Level	V _{IH}	—		V _{CC} -1.6	—	15	V
	"L" Level	V _{IL}			0	—	V _{CC} -3.6	
Input Current	"H" Level	I _{IH}	2		—	—	10	μA
	"L" Level	I _{IL}			—	-0.05	-0.36	mA
Output Leakage Current		I _{CEX}	1	V _{CE} = 80 V, Ta = 25°C	—	—	50	μA
				V _{CE} = 80 V, Ta = 85°C	—	—	100	
Output Saturation Voltage		V _{CE (sat)}	3	I _{OUT} = 0.5 A, V _{CC} = 4.5 V	—	—	0.8	V
				I _{OUT} = 0.2 A, V _{CC} = 4.5 V	—	—	0.45	
Clamp Diode Reverse Current		I _R	4	V _R = 80 V, Ta = 25°C	—	—	50	μA
				V _R = 80 V, Ta = 85°C	—	—	100	
Clamp Diode Forward Voltage		V _F	5	I _F = 500 mA	—	—	2.0	V
Supply Current	Output On	I _{CC (ON)}	2	V _{CC} = 5.5 V, V _{IN} = 0 V	—	35	40	mA / ch
	Output Off	I _{CC (OFF)}	2	V _{CC} = 5.5 V, V _{IN} = V _{CC}	—	—	10	μA
Turn-On Delay		t _{ON}	6	V _{OUT} = 80 V, R _L = 142 Ω V _{CC} = 5.0 V, C _L = 15 pF	—	0.4	0.8	μs
Turn-Off Delay		t _{OFF}			—	8.0	16.0	

TEST CIRCUIT

1. I_{CEX}

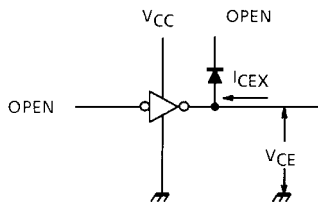

2. I_{IH}, I_{IL}

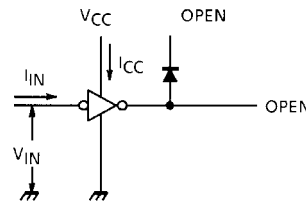

3. $V_{CE(sat)}$

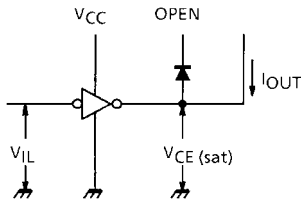

4. I_R

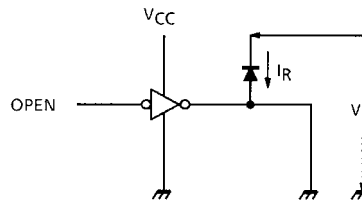

5. V_F

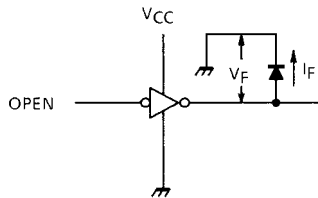

6. t_{ON}, t_{OFF}

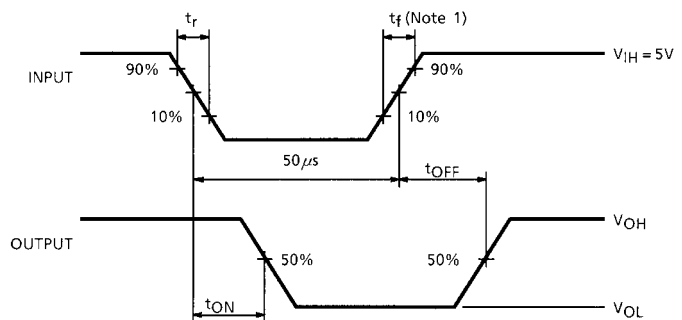
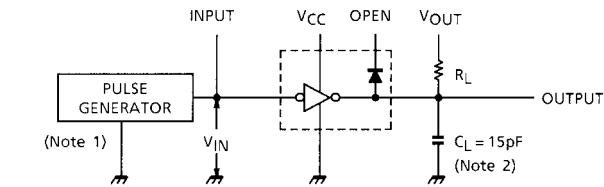

Note 1: Pulse Width 50 μ s, Duty Cycle 10%
Output Impedance 50 Ω , $t_r \leq 5$ ns, $t_f \leq 10$ ns

Note 2: C_L includes probe and jig capacitance.

PRECAUTIONS for USING

This IC does not include built-in protection circuits for excess current or overvoltage.

If this IC is subjected to excess current or overvoltage, it may be destroyed.

Hence, the utmost care must be taken when systems which incorporate this IC are designed.

Utmost care is necessary in the design of the output line, V_{CC} , COMMON and GND line since IC may be destroyed due to short-circuit between outputs, air contamination fault, or fault by improper grounding.

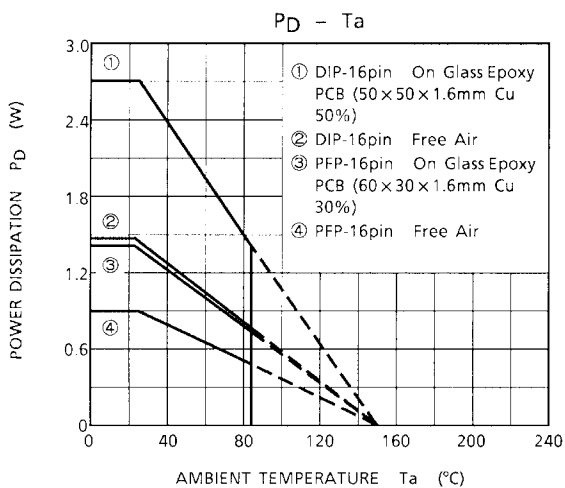
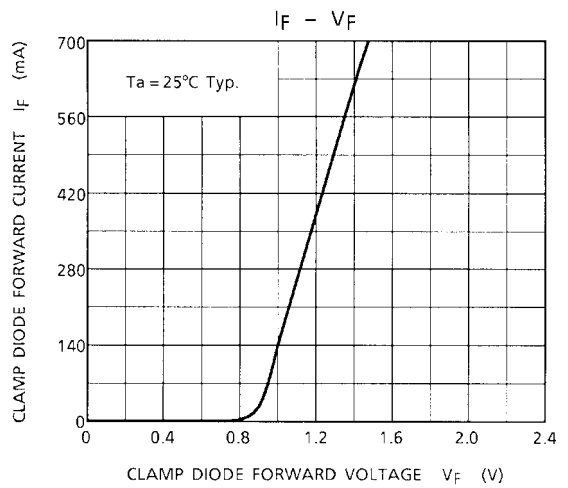
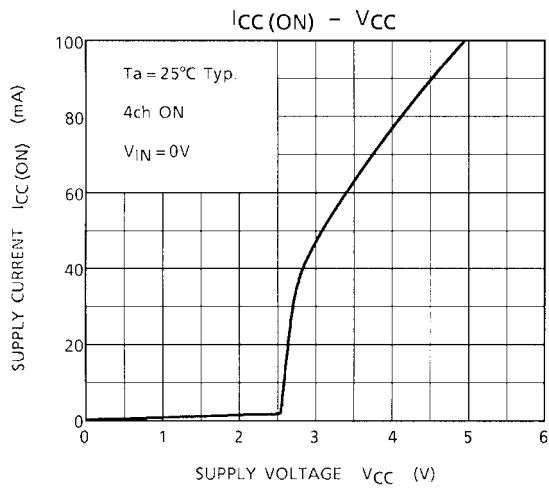
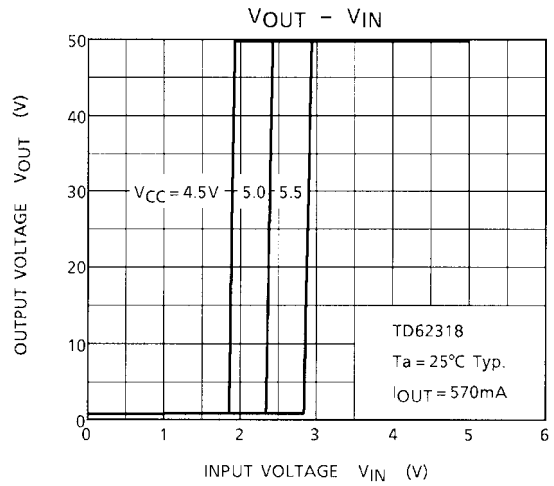
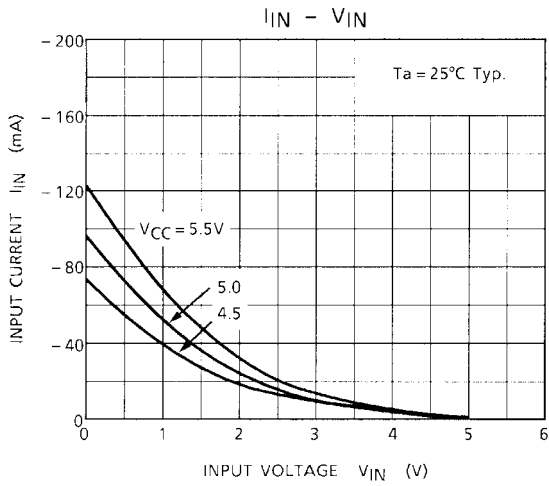

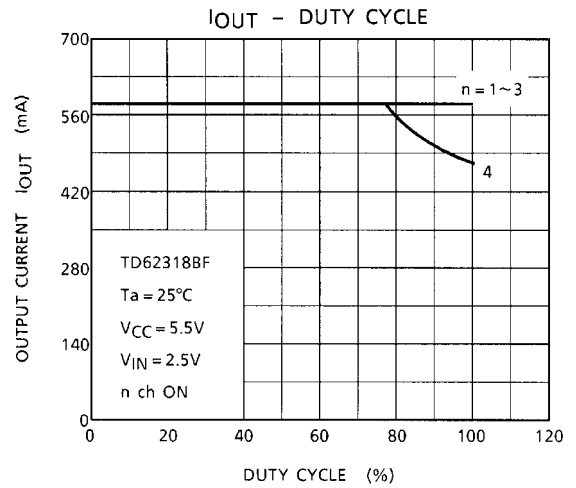
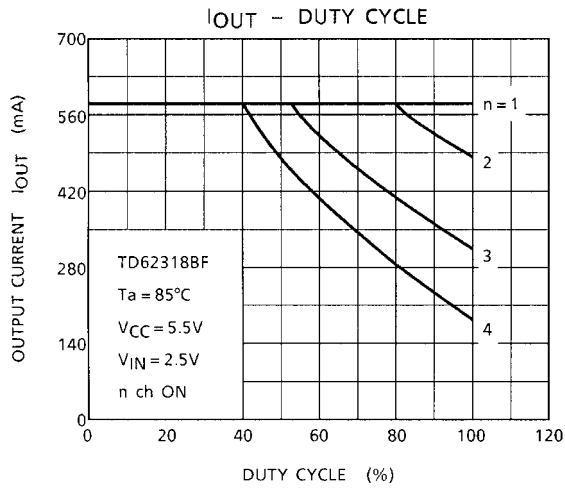
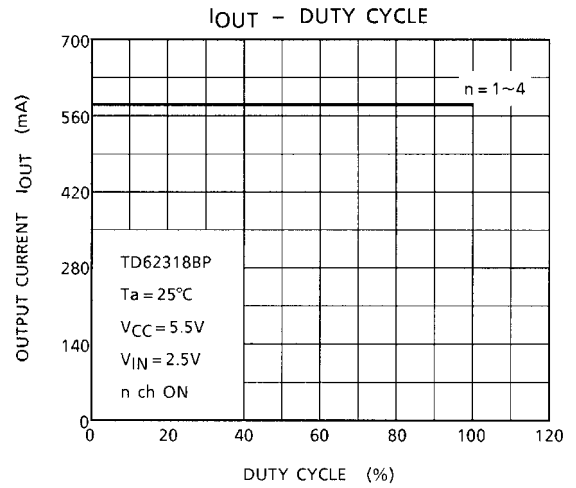
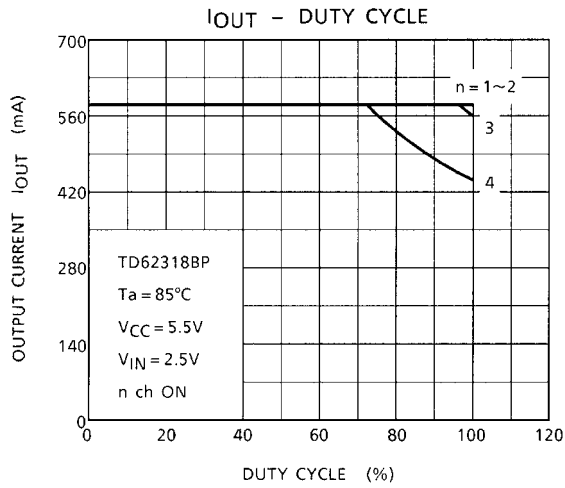

PACKAGE DIMENSIONS

DIP16-P-300-2.54A

Unit: mm

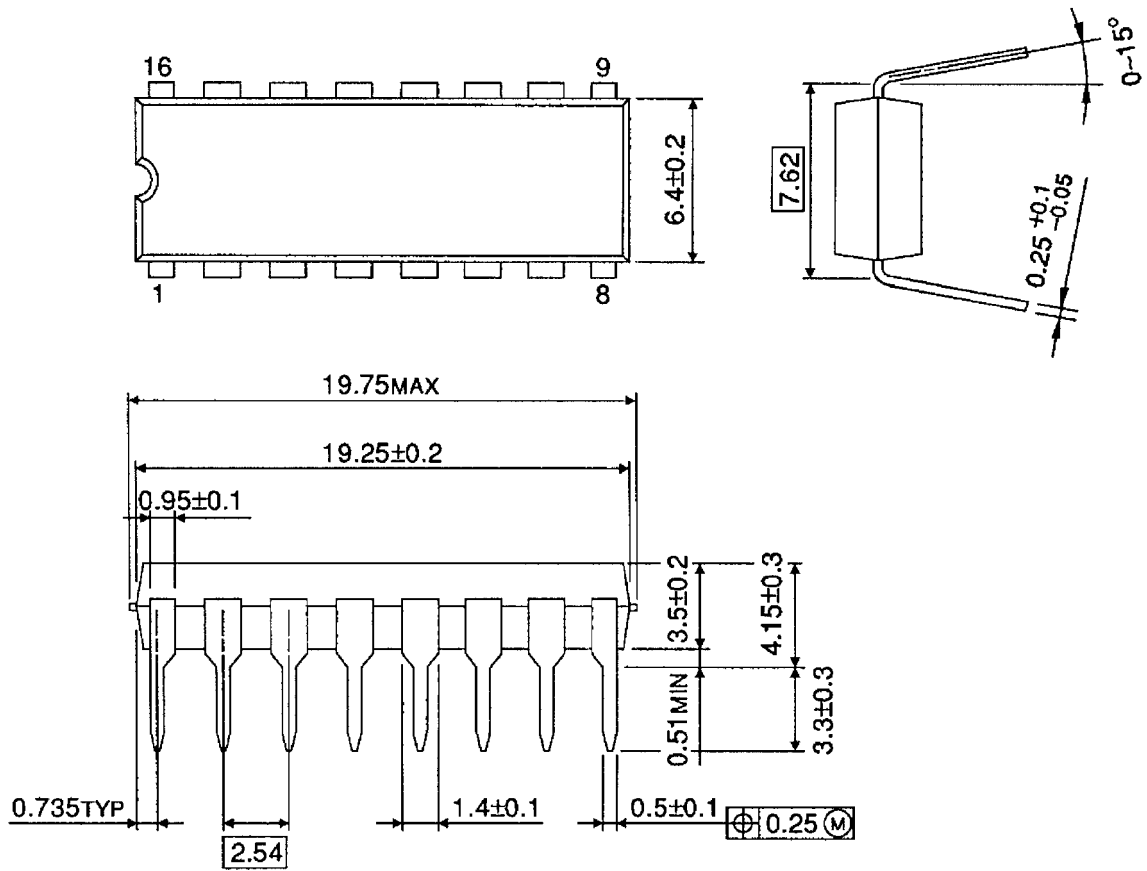

Weight: 1.11 g (Typ.)

PACKAGE DIMENSIONS

HSOP16-P-300-1.00

Unit: mm

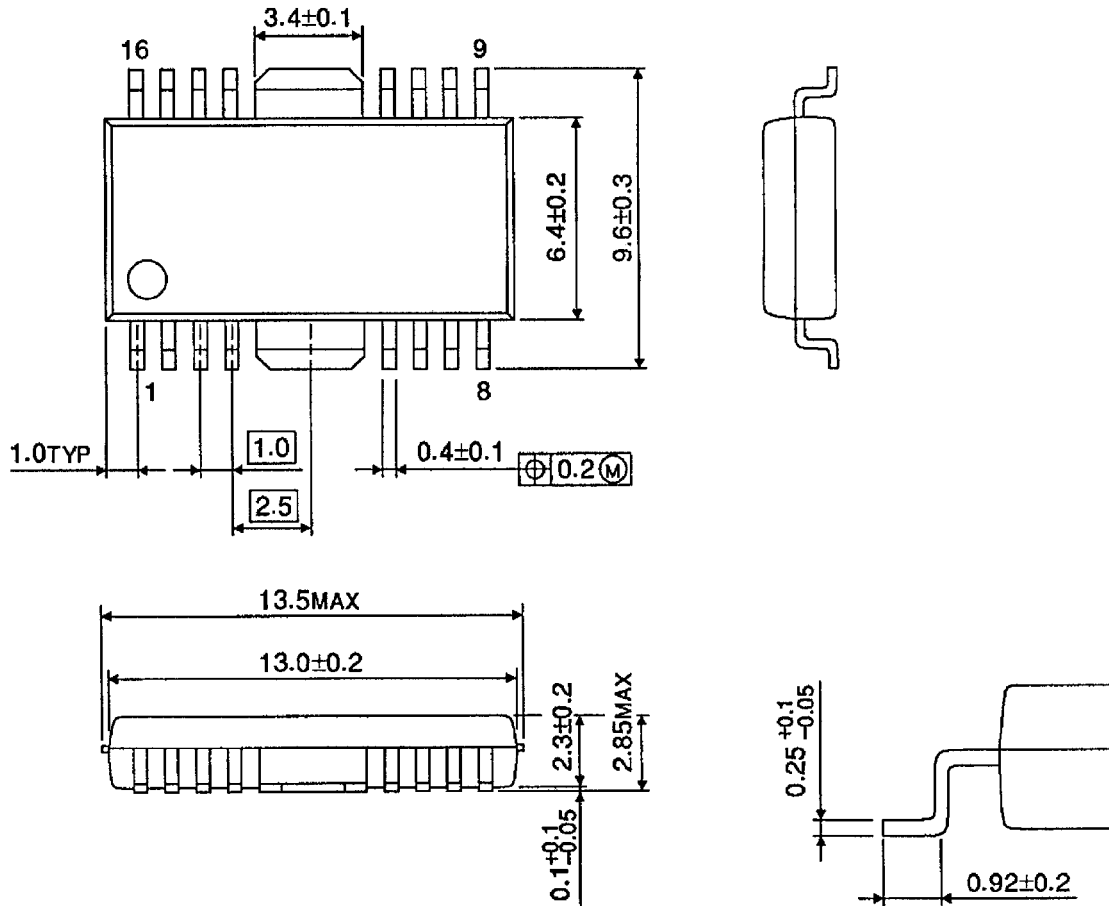

Weight: 0.50 g (Typ.)

RESTRICTIONS ON PRODUCT USE

000707EBA

- TOSHIBA is continually working to improve the quality and reliability of its products. Nevertheless, semiconductor devices in general can malfunction or fail due to their inherent electrical sensitivity and vulnerability to physical stress. It is the responsibility of the buyer, when utilizing TOSHIBA products, to comply with the standards of safety in making a safe design for the entire system, and to avoid situations in which a malfunction or failure of such TOSHIBA products could cause loss of human life, bodily injury or damage to property.
In developing your designs, please ensure that TOSHIBA products are used within specified operating ranges as set forth in the most recent TOSHIBA products specifications. Also, please keep in mind the precautions and conditions set forth in the "Handling Guide for Semiconductor Devices," or "TOSHIBA Semiconductor Reliability Handbook" etc..
- The TOSHIBA products listed in this document are intended for usage in general electronics applications (computer, personal equipment, office equipment, measuring equipment, industrial robotics, domestic appliances, etc.). These TOSHIBA products are neither intended nor warranted for usage in equipment that requires extraordinarily high quality and/or reliability or a malfunction or failure of which may cause loss of human life or bodily injury ("Unintended Usage"). Unintended Usage include atomic energy control instruments, airplane or spaceship instruments, transportation instruments, traffic signal instruments, combustion control instruments, medical instruments, all types of safety devices, etc.. Unintended Usage of TOSHIBA products listed in this document shall be made at the customer's own risk.
- The products described in this document are subject to the foreign exchange and foreign trade laws.
- The information contained herein is presented only as a guide for the applications of our products. No responsibility is assumed by TOSHIBA CORPORATION for any infringements of intellectual property or other rights of the third parties which may result from its use. No license is granted by implication or otherwise under any intellectual property or other rights of TOSHIBA CORPORATION or others.
- The information contained herein is subject to change without notice.