

TOSHIBA CMOS DIGITAL INTEGRATED CIRCUIT SILICON MONOLITHIC

TC9307AF

SINGLE CHIP DTS CONTROLLER WITH BUILT-IN PRESCALER·PLL·LCD DRIVER (DTS-12)

TC9307AF is a 4bit CMOS single chip microcontroller for digital tuning system with built-in prescaler, PLL and LCD driver.

It can compose a single chip type digital tuning system and is suitable for application to radio cassette equipment.

CPU has 4bit parallel addition and subtraction (AI/SI instructions), logical operation (OR, AN instructions), plural bit judge, comparison instructions (TM, SL instructions) and time base function.

The package is of 44-pin mini-flat type, and it provides with abundant I/O ports and exclusive key-input ports controlled by the powerful input/output instructions (IO, KEY instructions), and besides has exclusive LCD terminal of 1/4 duty·1/3 bias driving with built-in 3V voltage regulation circuit. 2-modulus prescaler, PLL circuit, and 16bit general purpose IF counter for generating auto-stop signal through counting IF signal are incorporated.

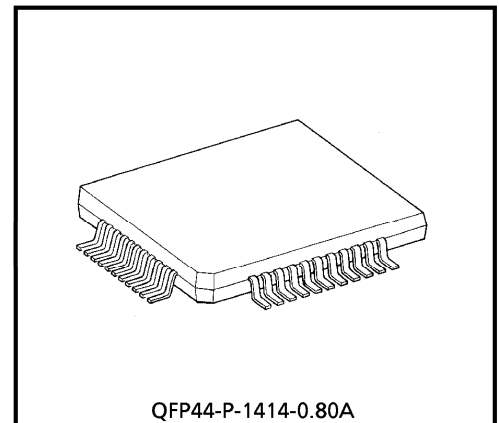

Weight : 0.8g (Typ.)

FEATURES

- 4bit microcontroller for digital tuning system.
- $5V \pm 10\%$ single power supply. CMOS structure with low power consumption.
 - At PLL operation : $V_{DD} = 4.5 \sim 5.5V$
 - At only CPU operation : $V_{DD} = 3.0 \sim 5.5V$
- Back up of data memory (RAM) and of various kinds of ports are easily made. (With \overline{INH} terminal)
- Built-in LCD driver (1/4 duty, 1/3 bias, driving frequency : 125Hz, 52 segment max.) and 3V voltage regulation circuit for display.
- Program memory (ROM) : 16bit \times 2048 steps.
- Data memory (RAM) : 4bit \times 128 words.
- 65 kinds of powerful instruction sets. (All are single-word instructions)
- Crystal resonator of 150kHz or 75kHz can be selected with program.
- Instruction execution time : 150kHz crystal connection : $40\mu s$
: 75kHz crystal connection : $80\mu s$
- Abundant instructions of addition and subtraction. (12 kinds of addition instruction, 12 kinds of subtraction instructions)
- Powerful compound judgment instructions. (TMTR, TMFR, TMT, TMF, TMTN, TMFN instructions)

- Data transfer in the same low address is possible.
- Indirect data transfer with registers is possible. (MVRD, MVRS, MVGD, MVGS instructions)
- Powerful 16 general registers. (arranged in RAM)
- Stack level : 1 level
- Program memory (ROM) has no conception of page, field, and JUMP and CAL instructions can be freely made among 2048 steps.
- It is possible to freely refer to the contents, 16 bits, of optional address within 1024 steps in program memory (ROM). (DAL instruction)
- Powerful input and output instruction (IO, KEY instructions)
- Exclusive input port (K0~K3) and output port (T0~T5) for key matrix.
- Abundant 19 I/O ports. (port which can be assigned to input or output for each bit : 7 (max.), exclusive input : 6 (max.), exclusive output port : 7)
- Port of segment outputs can be changed to I/O ports for each bit, and vice versa. (S10/P22, S11/P21, P20/S12, P13/S13)
- 3 kinds of back-up mode (only CPU operation, Crystal oscillation and Clock stop) can be selected by instructions. (CKSTP, WAIT instruction)
- 2Hz timer F/F, 8Hz timer F/F (4Hz at 75kHz crystal connection), 10Hz/20Hz interval pulse output are provided. (Internal port for time base use)
- Independent frequency input terminal at FM and AM (FM_{IN}, AM_{IN}) and two phase-comparator outputs (D01, D02)
- 9 kinds of reference frequency can be selected with program.
(At 150kHz crystal connection : 1kHz, 3kHz, 3.125kHz, 5kHz, 6.25kHz, 10kHz, 12.5kHz, 25kHz, 50kHz)
(At 75kHz crystal connection : 1kHz, 3kHz, 3.125kHz, 5kHz, 6.25kHz, 12.5kHz, 25kHz)
- Locked condition of PLL can be detected.
- 16bit universal-type IF counter is built in, and input terminal of IF counter can be changed to general purpose input port. (IF_{IN}/IN)

PIN CONNECTION

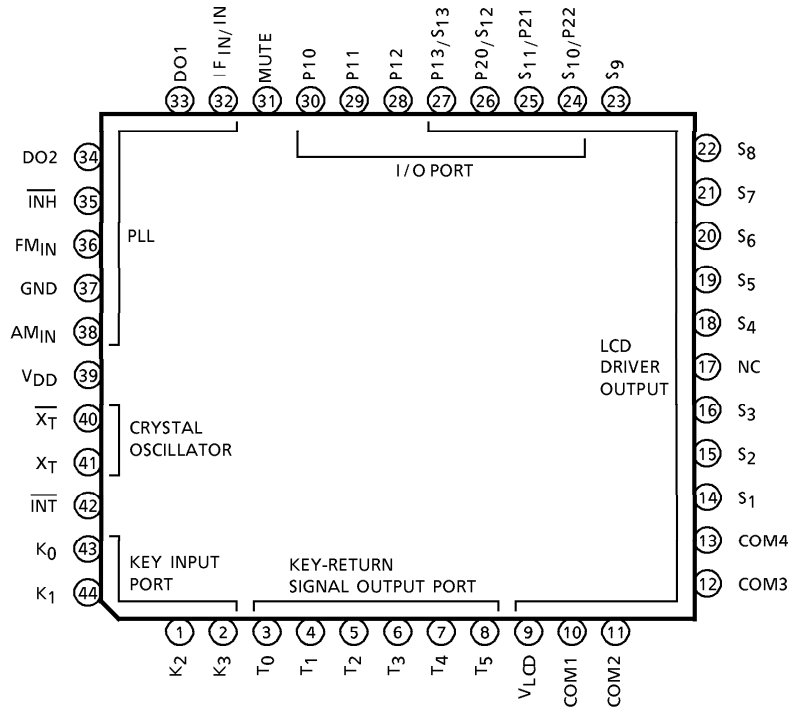

BLOCK DIAGRAM

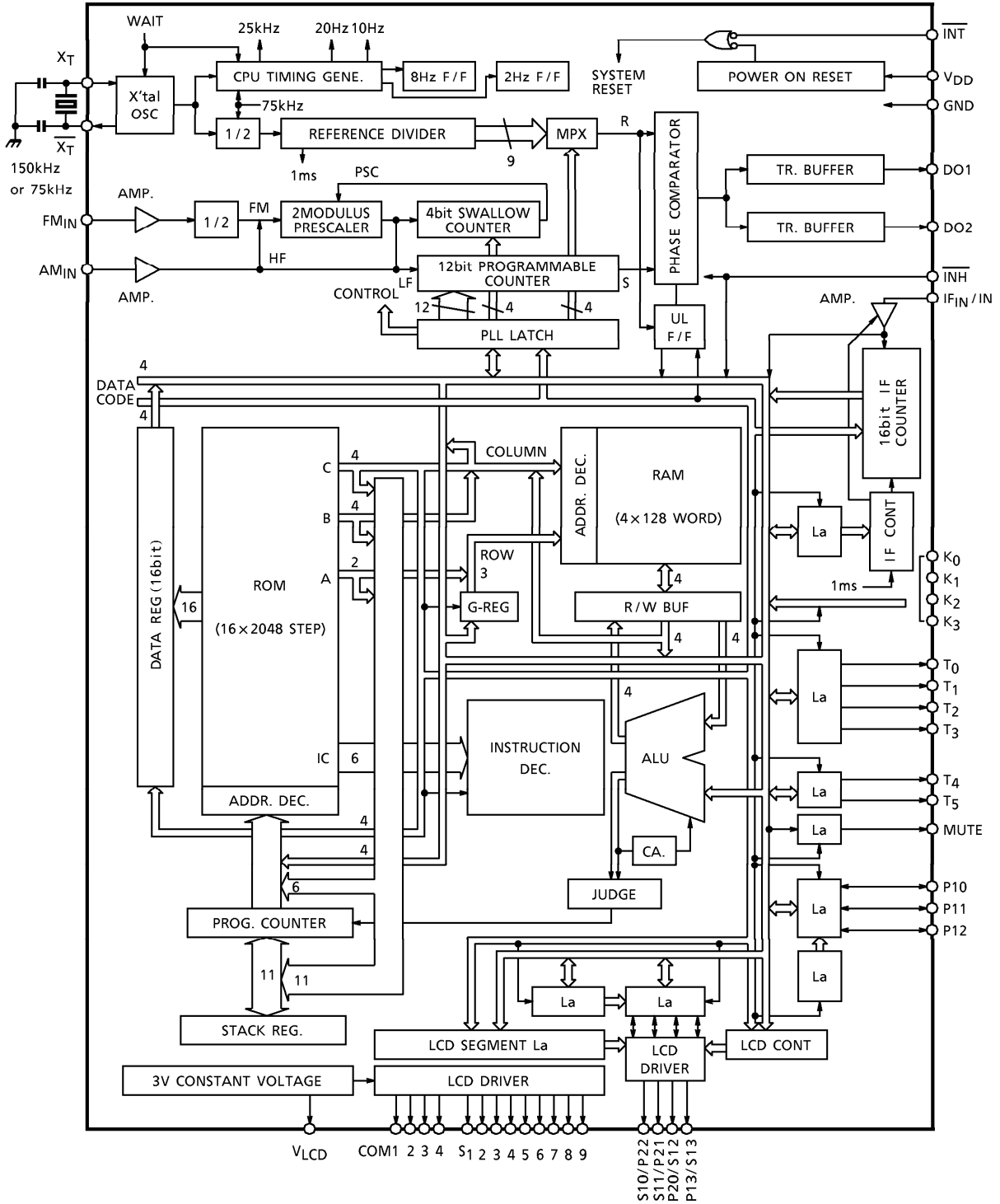

PIN FUNCTION

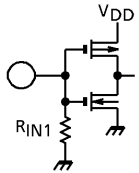
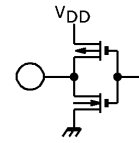
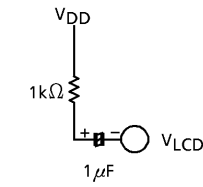
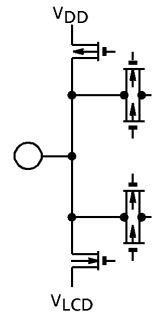
PIN No.	SYMBOL	PIN NAME	FUNCTION AND OPERATION	REMARKS
1, 2, 43, 44	K ₀ ~K ₃	Key Input Port	This is a 4bit input port for key matrix input. 24 (= 4×6) key can be used with matrix made with T ₀ ~T ₅ key return Timing Output Port. All these terminals are built in pull-down resistance.	
3~8	T ₀ ~T ₅	Key Return Timing Output Port	This is a 4bit output port for key Return Timing Output. Usually, it's used for output of the timing signal for key matrix.	
9	V _{LCD}	3V Regulation Voltage Output Terminal	This is a 3V regulation voltage output terminal for driving LCD. Connect the resistance and capacitors in series between V _{DD} and V _{LCD} terminal. (Typ. R = 1kΩ, C = 1μF) As regulation voltage output has temperature characteristic of -15mV/°C, it can control the influence of temperature on LCD display. (Note)Output is fixed "H" level at executing system reset and CKSTP instruction.	
10~13	COM1 ~COM4	LCD Common Output	This is a LCD drive output terminal of 1/4 duty, 1/3 bias type. Display of maximum 52 segments are available with matrix made with COM1~COM4 and S1~S13. The frame frequency is 125kHz and it outputs four value of voltage V _{DD} , 1/3 level, 2/3 level, V _{LCD} .	
14~23	S ₁ ~S ₉	LCD Segment Output	The data of segment terminal is output by the execution of SEG instruction and MARK instruction. (Note)Output is fixed "H" level at executing system reset and CKSTP instruction.	

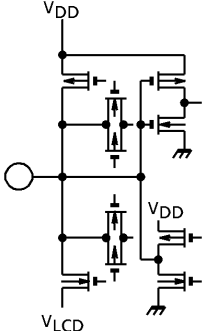
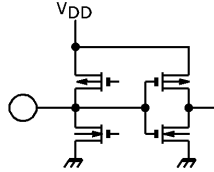
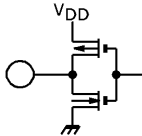
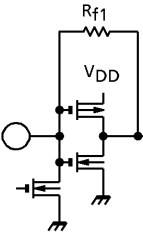
PIN No.	SYMBOL	PIN NAME	FUNCTION AND OPERATION	REMARKS
24, 25	S10/P22 S11/P21	LCD Segment Output / I/O Port	<p>This terminal can be used both as I/O port and segment output. It can be assigned to general I/O port or segment output for each bit by program.</p> <p>Assignment to I/O port on segment output is executed by contents of segment control port.</p> <p>At using as I/O port, it can set up the input/output port for each bit.</p>	
26, 27	P20/S12 P13/S13	I/O Port / LCD Segment Output	<p>(Note)At executing system reset, each terminal is set up segment output (S10, S11) and input port (P20, P13).</p> <p>At executing CKSTP instruction, segment output is fixed "H" level and Output port is "L" level automatically.</p>	
28~30	P10~P12	I/O Port	<p>These are 3bit general purpose I/O port. It can be assigned to input or output for each bit by program.</p> <p>(Note)At system reset, I/O port is set up input, port.</p> <p>At executing CKSTP instruction, output port is fixed at "L" level automatically.</p>	
31	MUTE	Muting Output Port	<p>This is a 1bit output port. This is usually used as muting control signal output.</p>	
32	IFIN/IN	IF Counter Input / Input Port	<p>This is a IF signal input terminal of 16bit general purpose IF counter and can be input frequency of 0.3~12MHz (0.4V_{p-p} min.).</p> <p>This terminal has built-in amplifiers, and operates with C-connection and small amplitude. This terminal can be used as input port by content of IN control port.</p> <p>(Note)At assignment of IF inputs, when $\overline{\text{INH}}$ terminal is "L" level, this terminal is set up pull-down.</p>	

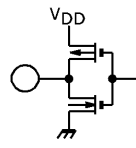
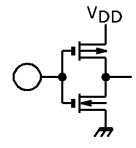
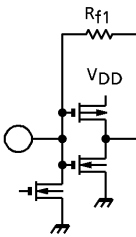
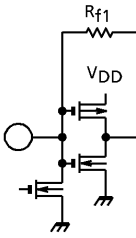
PIN No.	SYMBOL	PIN NAME	FUNCTION AND OPERATION	REMARKS
33, 34	DO1, DO2	Phase Comparator Output	This is a Phase comparator output terminal of PLL. DO1 and DO2 are parallel outputs. Therefore, optimum filter constant can be designed for each band of FM/AM.	
35	$\overline{\text{INH}}$	Inhibit Input	This is a signal input terminal for selecting radio mode. "H" : radio ON, "L" : radio OFF In radio OFF mode, PLL and IF counter become reset condition. Further, if CKSTP instruction is used in the program and this CKSTP instruction is executed while $\overline{\text{INH}}$ is at "L" level, the internal clock generator and CPU stop their operations, and memory back up condition can be realized at low current consumption (less than $1\mu\text{A}$). At this time, segment output terminal is fixed "H" level and other output is "L" level automatically.	
36	FM_{IN}	FM Programmable Counter Input	Prescaler input terminal at FM band. Local oscillator output signal (VCO output) of 50~130MHz is input. This terminal has built-in amplifier and operates with C-connection and small amplitude. (Note) In LF mode or HF mode and $\overline{\text{INH}} = \text{"L"}$ level, this terminal is set up pull-down.	
38	AM_{IN}	AM Programmable Counter Input	Programmable counter input terminal at AM band. Direct-dividing mode (LF mode) and Pulse-swallow mode (HF mode) can freely be changed over. In direct-dividing mode, local oscillator output signal (VCO output) of 0.5~10MHz (0.4V _{p-p} min.) is input, and in pulse-swallow mode, local oscillator output signal of 5~60MHz (0.4V _{p-p} min.) is input. This terminal has built-in amplifier and operates with C-connection and small amplifier. (Note) In FM mode an $\overline{\text{INH}} = \text{"L"}$ level, the terminal is set up pull-down	

PIN No.	SYMBOL	PIN NAME	FUNCTION AND OPERATION	REMARKS
40	$\overline{X_T}$	Crystal Oscillation Terminal	This is a crystal oscillation terminal. Connect 150kHz or 75kHz crystal resonator for reference. Selection of 150kHz/75kHz is executed by contents of internal 75kHz port. (75kHz = "0" : 150kHz, 75kHz = "1" : 75kHz) At executing CKSTP instruction, crystal oscillation stops.	
41	X_T			
42	\overline{INT}	Initializing Input	This is a system reset signal input terminal of device. During \overline{INT} is at "L" level, reset is applied, and when "H" level is reached, program starts from address 0. When voltage of 0V→3V is supplied to V_{DD} terminal, system reset is usually executed (power-on reset), so this terminal is fixed at "H" level to be used. (Note)If power supply voltage is applied to V_{DD} terminal at "L" level of \overline{INT} terminal, device is set up test mode condition.	
39	V_{DD}	Power Supply Terminal	This is power supply terminal. At PLL operation, voltage of 4.5~5.5V is supplied. At CPU operation only, supply voltage can be reduced down to 3V and further, down to 1.7V at back up condition (at executing CKSTP instruction). When voltage of 0V→3V is supplied to this terminal, system reset is executed to device and program starts from address 0. (Power-on reset) (Note)For power-on reset operation, design the rising time of power supply voltage to device to be time of 10~100ms. (Note)As the content of each port (output port, internal port, etc.) is indefinite at the time of power supply, so initialization must be made by program according to your use.	—
37	GND			

MAXIMUM RATINGS (Ta = 25°C)

CHARACTERISTIC	SYMBOL	RATING	UNIT
Power Supply Voltage	V _{DD}	-0.3~6.0	V
Input Voltage	V _{IN}	-0.3~V _{DD} + 0.3	V
Power Dissipation	P _D	400	mW
Operating Temperature	T _{opr}	-20~60	°C
Storage Temperature	T _{stg}	-55~125	°C

ELECTRICAL CHARACTERISTICS (Unless otherwise specified, Ta = 25°C, V_{DD} = 5.0V)

CHARACTERISTIC	SYMBOL	TEST CIRCUIT	TEST CONDITION	MIN.	TYP.	MAX.	UNIT
Operating Power Supply Voltage Range	V _{DD1}	—	At CPU, PLL operation *	4.5	5.0	5.5	V
	V _{DD2}	—	At only CPU operation *	3.0	5.0	5.5	
	V _{HD}	—	Crystal oscillation stops (Excuting CKSTP instrucion) *	1.7	~	5.5	
Operating Power Supply Current	I _{DD1}	—	At CPU, PLL operation, F _{M_{IN}} = 130MHz	—	10	25	mA
	I _{DD2}	—	At only CPU operation, X _T = 150kHz V _{DD} = 5V	—	100	200	
	I _{DD3}	—	At only CPU operation, X _T = 75kHz V _{DD} = 5V	—	50	100	
	I _{DD4}	—	At only crystal oscillation, X _T = 150kHz V _{DD} = 5V	—	80	150	μA
	I _{DD5}	—	At only crystal oscillation, X _T = 75kHz V _{DD} = 5V	—	40	80	
Memory Holding Power Supply Current	I _{HD}	—	Crystal oscillation stop, V _{DD} = 5V	—	0.07	1.0	
Crystal Oscillation Frequency	f _{X_T}	—	*	—	75 or 150	—	kHz

Programmable counter, IF counter

Operating Frequency Range	f _{FM}	—	F _{M_{IN}} input, V _{IN} = 0.4V _{p-p} *	50	~	130	MHz
	f _{HF}	—	A _{M_{IN}} input (HF mode), V _{IN} = 0.4V _{p-p} *	5	~	60	
	f _{LF}	—	A _{M_{IN}} input (LF mode), V _{IN} = 0.4V _{p-p} *	0.5	~	10	
	f _{IF}	—	I _{F_{IN}} input, V _{IN} = 0.4V _{p-p} *	0.3	~	12	
Operating Input Amplitude Range	f _{FM}	—	F _{M_{IN}} input, F _{IN} = 50~130MH *	0.4	~	V _{DD} - 0.5	V _{p-p}
	f _{HF}	—	A _{M_{IN}} input (HF mode), F _{IN} = 5~60MHz *	0.4	~	V _{DD} - 0.5	
	f _{LF}	—	A _{M_{IN}} input (LF mode), F _{IN} = 0.5~10MHz *	0.4	~	V _{DD} - 0.5	
	f _{IF}	—	I _{F_{IN}} input, F _{IN} = 0.3~12MHz *	0.4	~	V _{DD} - 0.5	
Amp. Feedback Resisitance	R _{f1}	—	F _{M_{IN}} , A _{M_{IN}} , I _{F_{IN}} input	250	500	1500	kΩ

(Note) Items marked with * are guaranteed within the range of V_{DD} = 4.5~5.5V, Ta = -20~60°C

CHARACTERISTIC	SYMBOL	TEST CIR-CUIT	TEST CONDITION	MIN.	TYP.	MAX.	UNIT
----------------	--------	---------------	----------------	------	------	------	------

3V voltage regulation circuit for LCD driving, LCD output

Regulation Voltage Range	V_{LCD}	—	V_{DD} Reference	-3.25	-3.0	-2.75	V
Temperature Characteristic Of Regulation Voltage	D_V	—	—	—	-15	—	mV/°C
Output Voltage	1/3 Level	V_{O1}	$V_{LCD} = 2V, V_{DD} = 5V, \text{No-Load, GND Reference}$	2.8	3.0	3.2	V
	2/3 Level	V_{O2}	$V_{LCD} = 2V, V_{DD} = 5V, \text{No-Load, GND Reference}$	3.8	4.0	4.2	

MUTE, $T_0 \sim T_5$, P10~P22

Output Current	"H" Level	I_{OH1}	—	$V_{OH} = 4.0V$	-2.0	-7.0	—	mA
	"L" Level	I_{OL1}	—	$V_{OL} = 1.0V$	2.0	5.0	—	
Input Voltage	"H" Level	V_{IH1}	—	(P10~P22)	3.5	~	5.0	V
	"L" Level	V_{IL1}	—	(P10~P22)	0	~	1.5	
Input Leakage Current		I_{LI}	—	$V_{IH} = 5.0V, V_{IL} = 0V$ (P10~P22)	—	—	± 1.0	μA

D01, 2 output

Output Current	"H" Level	I_{OH1}	—	$V_{OH} = 4.0V$	-2.0	-7.0	—	mA
	"L" Level	I_{OL1}	—	$V_{OL} = 1.0V$	2.0	5.0	—	
Output Off-Leakage Current		I_{TL}	—	$V_{TLH} = 5.0V, V_{TLL} = 0V$	—	—	± 100	nA

\overline{INT} input, input port ($K_0 \sim K_3$, IN)

Input Voltage	"H" Level	V_{IH1}	—	—	3.5	~	5.0	V
	"L" Level	V_{IL1}	—	—	0	~	1.5	
Input Leakage Current		I_{LI}	—	(\overline{INT} , IN Input) $V_{IH} = 5.0V$ $V_{IL} = 0V$	—	—	± 1.0	μA
Input Pull-Down Resistance		R_{IN1}	—	($K_0 \sim K_3$ Input)	50	150	300	k Ω

INH input port

Input Voltage	"H" Level	V_{IH2}	—	—	4.3	~	5.0	V
	"L" Level	V_{IL2}	—	—	0	~	2.7	
Input Leakage Current		I_{LI}	—	$V_{IH} = 5.0V, V_{IL} = 0V$	—	—	± 1.0	μA

Crystal oscillation terminal

Amp. Feedback Resistance	R_{f2}	—	($\overline{X_T}$ Input)	1	5	15	M Ω
$\overline{X_T}$ Output Resistance	R_{OUT}	—	($\overline{X_T}$ Output)	50	150	300	k Ω

PACKAGE DIMENSIONS
QFP44-P-1414-0.80A

Unit : mm

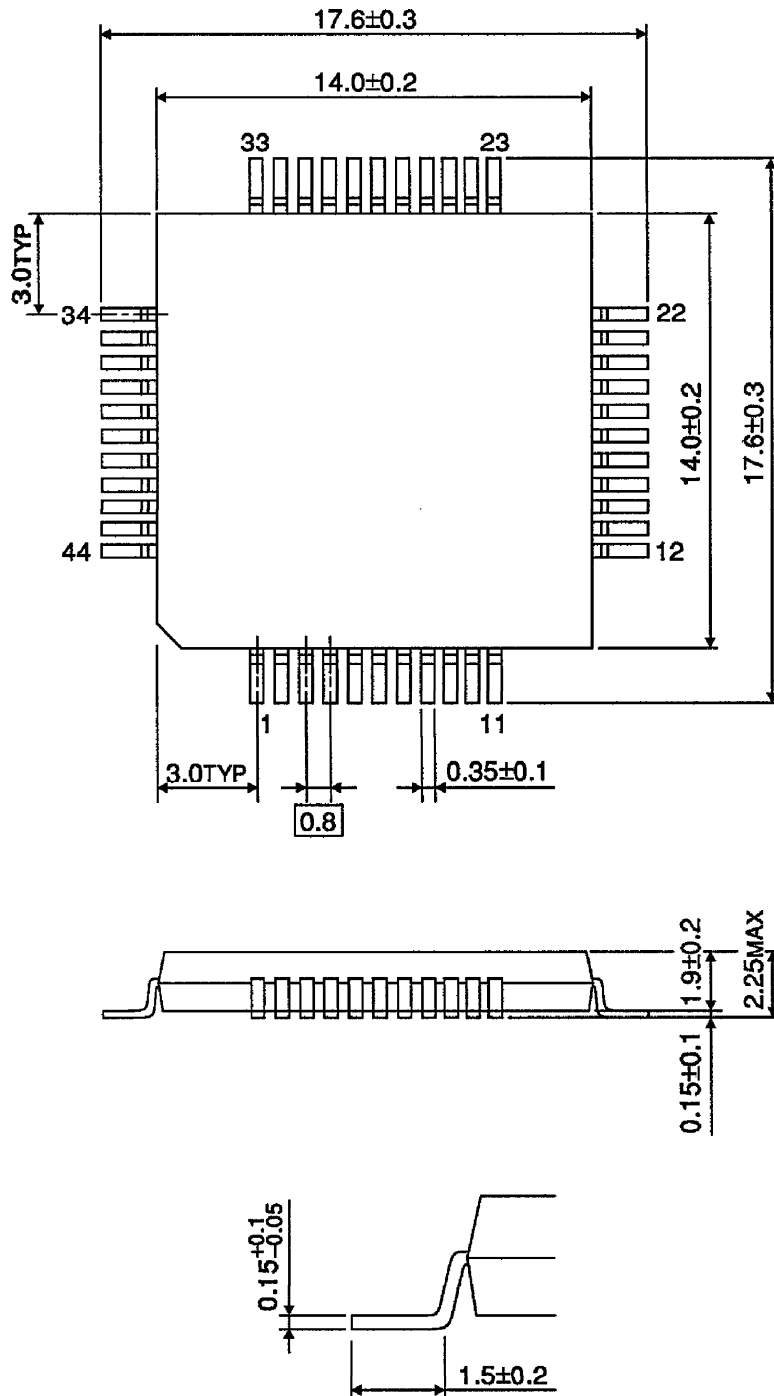

Weight : 0.8g (Typ.)

RESTRICTIONS ON PRODUCT USE

000707EBA

- TOSHIBA is continually working to improve the quality and reliability of its products. Nevertheless, semiconductor devices in general can malfunction or fail due to their inherent electrical sensitivity and vulnerability to physical stress. It is the responsibility of the buyer, when utilizing TOSHIBA products, to comply with the standards of safety in making a safe design for the entire system, and to avoid situations in which a malfunction or failure of such TOSHIBA products could cause loss of human life, bodily injury or damage to property. In developing your designs, please ensure that TOSHIBA products are used within specified operating ranges as set forth in the most recent TOSHIBA products specifications. Also, please keep in mind the precautions and conditions set forth in the "Handling Guide for Semiconductor Devices," or "TOSHIBA Semiconductor Reliability Handbook" etc..
- The TOSHIBA products listed in this document are intended for usage in general electronics applications (computer, personal equipment, office equipment, measuring equipment, industrial robotics, domestic appliances, etc.). These TOSHIBA products are neither intended nor warranted for usage in equipment that requires extraordinarily high quality and/or reliability or a malfunction or failure of which may cause loss of human life or bodily injury ("Unintended Usage"). Unintended Usage include atomic energy control instruments, airplane or spaceship instruments, transportation instruments, traffic signal instruments, combustion control instruments, medical instruments, all types of safety devices, etc.. Unintended Usage of TOSHIBA products listed in this document shall be made at the customer's own risk.
- The products described in this document are subject to the foreign exchange and foreign trade laws.
- The information contained herein is presented only as a guide for the applications of our products. No responsibility is assumed by TOSHIBA CORPORATION for any infringements of intellectual property or other rights of the third parties which may result from its use. No license is granted by implication or otherwise under any intellectual property or other rights of TOSHIBA CORPORATION or others.
- The information contained herein is subject to change without notice.