

TA2159F

FM Synthesizer Tuner

TA2159F is the FM synthesizer tuner with built-in FM front end, FM IF/detector, FM stereo decoder, PLL and system microcontroller which is designed for 3 V audio equipment.

Since the IC is equipped with an UP-SEARCH key, it can be used to receive broadcasts by itself.

Features

- Low supply current. ($V_{CC} = 3\text{ V}$, $T_a = 25^\circ\text{C}$)
 $I_{CC} = 17\text{ mA}$ (typ.)
- Operating supply voltage range: $V_{CC} = 1.8\sim 3.6\text{ V}$ ($T_a = 25^\circ\text{C}$)
- Tuner Block
 - For NEW FCC.
 - Built-in mute circuit for IF count output.
 - For adopting ceramic discriminator, it is not necessary to adjust the FM quad detector circuit.
 - Built-in FM MPX VCO circuit.
- PLL/Controller Block
 - Reference frequency: 3.125 kHz
 - Data transfer: By 3-line R/W (read/write), CK (clock), and DATA (data) bus
And by 2-line UART (transfer speed 1200 bps)
 - Oscillator frequency: 75 kHz
 - UP-SEARCH key input: Controls tuner without microcontroller
 - Area selection: Japan, 76~90 MHz @100 kHz steps
:EUR. and USA 87.5~108 MHz @50 kHz steps
 - Auto search function: IF count method ($1/8\text{ IF} = 1.3375\text{ MHz}$)

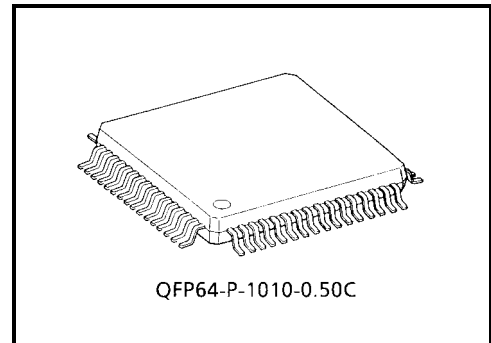

Weight: 0.48 g (typ.)

Pin Assignment

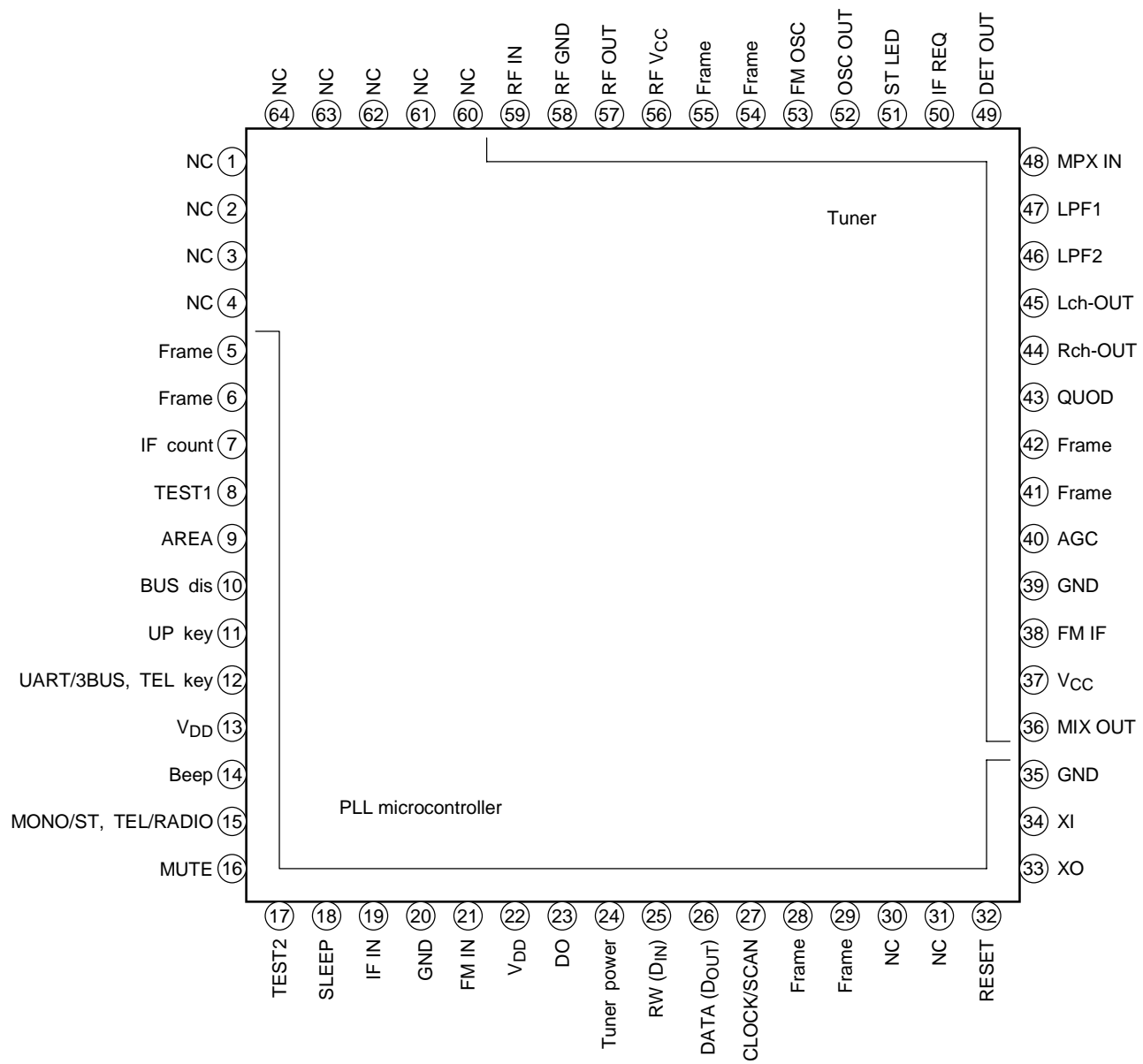

Pin Descriptions

1. Tuner

Pin No.	Characteristics	Internal Circuit	Terminal Voltage at No Signal (typ.) (V)
			FM
36	MIX OUT		3.0
37	V _{CC} (V _{CC} for FM IF, FM MPX stage)	—	3.0
38	FM IF IN		3.0
39	GND (GND for FM IF, FM MPX stage)	—	0
40	AGC		0

Pin No.	Characteristics	Internal Circuit	Terminal Voltage at No Signal (typ.) (V)
			FM
43	QUOD		2.2
44 45	R-OUT L-OUT		1.2
46	LPF2 • LPF terminal for phase detector.		2.2
47	LPF1 • LPF terminal for synchronous detector. • V _{CO} stop terminal. V ₄₇ = GND → V _{CO} STOP		2.4

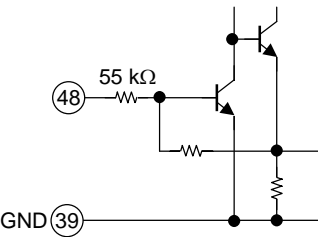
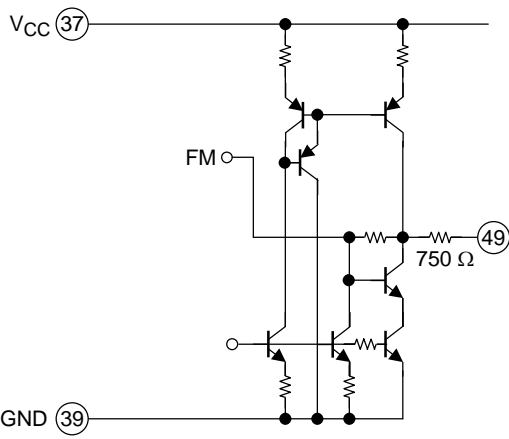
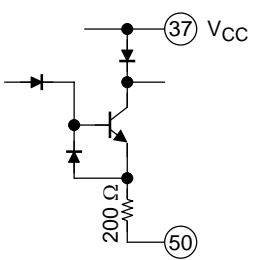
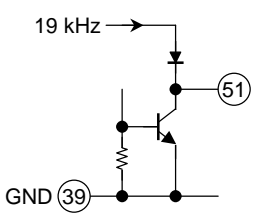
Pin No.	Characteristics	Internal Circuit	Terminal Voltage at No Signal (typ.) (V)
			FM
48	MPX IN		0.7
49	DET OUT		0.9
50	IF REQ		—
51	ST LED		—

Pin No.	Characteristics	Internal Circuit	Terminal Voltage at No Signal (typ.) (V)
			FM
52	OSC OUT		2.7
53	FM OSC		3.0
56	RF V _{CC} (V _{CC} for FM RF stage)	—	3.0
57	FM RFout	Cf. pin 59	3.0
58	RF GND (GND for FM RF stage)	—	0
59	FM-RFin		0.8
5, 6, 28, 29, 41, 42, 54, 55	NC (pellet frame)	Connected to pellet frame. Either connect to GND or leave open.	—
1, 2, 3, 4, 30, 31, 60, 61, 62, 63, 64,	NC	These pins are also open internally, so can be used as relay pins.	—

2. PLL microcontroller

PIN No.	Symbol	Pin Name	Function and Operation	Remarks
7	IF-NOISE	IF amp input noise cut control output	<p>Cuts noise on the IF amp input pin at normal reception by connecting via C to pins 50 (IF REQ) and 19 (IF IN).</p> <p>At normal reception: Outputs Low level. At IF seek: Open</p>	
8	TEST1	Test mode control input	<p>Inputs Test mode control signal.</p> <p>When High is input, Test mode; when Low, normal operation.</p> <p>Use by applying Low level.</p>	
9	AREA	Area input	<p>Inputs area setting signal.</p> <p>Japan: Inputs High 76~90 MHz @100 kHz steps Eur. and U.S.A.: Inputs Low 87.5~108 MHz @50 kHz steps</p>	
10	BUS dis	Transmission mode switching input	<p>Inputs Transmission/No-Transmission mode selection signal.</p> <p>Transmission mode: Inputs Low. Pin 25: RW (D_{IN}) Pin 26: DATA (D_{OUT}) Pin 27: CLOCK</p> <p>No-Transmission mode: Inputs High. Pin 25: Outputs Low. Pin 26: Outputs Low. Pin 27: SCAN input</p> <p>Output Low is set at SLEEP = Low mode. Insert pullup resistor to input High at No-Transmission mode</p>	
11	UP key	UP-SEARCH key input	<p>Starts up-search when UP-SEARCH key is Low. Automatically detects a station and stops. If no station detected at transmission mode, continue searching. If no station detected after a whole search at no-transmission mode, selects fmin. 76 MHz or 87.5 MHz, outputs a beep, and turns off the radio. The radio turns on when the up key is pressed, and starts up-search.</p> <p>When not using keys, leave the pin open. When SLEEP = Low, output is set to Low (pull-up off).</p>	

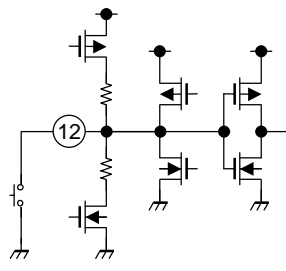
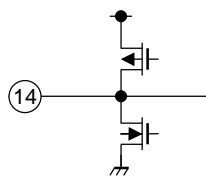
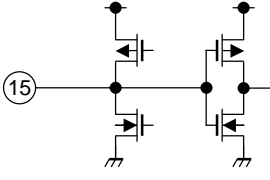
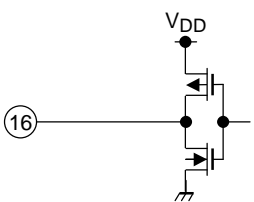
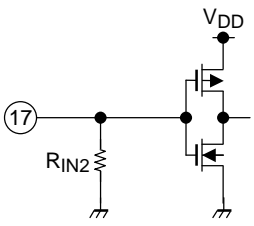
PIN No.	Symbol	Pin Name	Function and Operation	Remarks
12	UART/3BUS	UART 3BUS switching input	When BUS dis = Low, inputs 3BUS selection signal. Because output is High at sleep mode, input High through pullup resistor. 3BUS = Inputs Low. UART = Inputs High.	
	TEL key	TEL input key	When BUS dis = High, this key is the TEL input key. Every time this key falls to Low level, pin 15 (TEL/RADIO) output is set to Low → High → Low, and soon. When TEL/RADIO = Low, turns off the radio; when High, turns on the radio. When not using the TEL key, leave the pin open. When SLEEP = Low, output is set to Low (pull-up off).	
14	Beep	Beep output	Searches for the station when the UP-SEARCH key is pressed at no-transmission mode. If a station is not detected after a whole search or an automatic preset scan, outputs a beep.	
15	MONO/ST	MONO /STREO control output	Directly connected to pin 47 (LPF1) of the tuner block. Controls output and forced mono according to the BUS data. STREO = Input mode (open) MONO = Outputs Low.	
	TEL/RADIO	TEL/RADIO status output	When BUS dis = H, switches output from Low to High every pin 12 (TEL key) input. Radio = Outputs High. TEL = Outputs Low (radio off).	
16	MUTE	Muting output mode	Output mode, normally used for muting control signal output. The signal is used as IF count ON/OFF signal in tuner block and MUTE signal.	
17	TEST2	Test mode control input	Input pin used for controlling TEST mode. "H" (high) level indicates TEST mode, while "L" (low) indicates normal operation. Since a pull-down resistor is built into the pin, at normal operation, leave the pin open or set it to Low.	

PIN No.	Symbol	Pin Name	Function and Operation	Remarks
18	SLEEP	Sleep input	<p>If SLEEP = Low while V_{DD} is being applied, the device enters Ultra-Low Current Dissipation mode where memory only is backed up by stopping crystal oscillation, PLL, and the CPU.</p> <p>At that time, V_{DD} can be dropped to 0.75 V.</p> <p>When V_{DD} is less than 0.75 V, this function will be reset. The minimum frequency 87.5 MHz or 76 MHz will be set at transmission mode on power on.</p> <p>To restore from back-up state, set the pin from Low to High. Turn the radio on at the same time.</p>	
19	IF IN	IF signal input	<p>IF signal input pin for the IF counter to count the IF signals of the FM band and to detect the automatic stop position.</p> <p>The input frequency is between 0.3 to 12 MHz. A built-in input amp. and C coupling allow operation at low-level input.</p> <p>Note: The internal IF amp is operated whether the IF counter is ON or OFF, and the noise level will be increased. Toshiba recommend connect the pin to GND using the pin 7 (IF-NOISE) signal at normal operation.</p>	
13, 22	V_{DD}	Power-supply pins	<p>Power supply pins.</p> <p>Normally, $V_{DD} = 3.0$ V is applied.</p>	
20, 35	GND			
21	FM IN	local oscillation signal input	<p>Direct division method.</p> <p>Input range: 5 to 8 MHz</p> <p>Note: In PLL OFF mode, input is at high impedance.</p>	
23	DO	Phase comparator output	<p>PLL phase comparator output pin.</p> <p>Tri-state output.</p> <p>When programmable counter divided frequency output is higher than the reference frequency, High level is output; when lower, Low level is output; when they match, high impedance. When the radio is off, output Low is fixed.</p>	

PIN No.	Symbol	Pin Name	Function and Operation	Remarks
24	TUNER Power	Tuner block power control output	Turns on/off a PNP transistor and controls (switches on/off) the tuner block power supply. At power on (D5 = 1): Outputs Low. At power off (D5 = 0): Open When the radio is off or in Sleep mode, the pin is open. At Radio on or Sleep is released, the pin outputs Low.	
25, 26, 27	RW (D _{IN}) DATA (D _{OUT}) CLOCK	Serial data input/output	When BUS dis = Low, inputs/outputs serial data. Switches the pin function according to the state of pin 12 (UART/3BUS). UART Pin 12 = High Pin 25 = D _{IN} Pin 26 = D _{OUT} Pin 27 = Open 3BUS Pin 12 = "L" Pin 25 = RW Pin 26 = DATA Pin 27 = CLOCK When the operation is only by the UP key without the cable, pullup 25 pin, and fix the input High for both UART and 3BUS.	
	OUT "L" OUT "L" SCAN	SCAN key input	When BUS dis = High: Since pins 25 and 26 output Low, leave open or connect to GND. Pin 27 inputs active high SCAN key signal. 1. Pressing the SCAN key and UP-SEARCH keys together, the auto pre-set scan starts from the point at the UP-SERCH key is at High. If no station detected, selects fmin. 76 MHz or 87.5 MHz, outputs a beep, and turns off the radio. 2. Every time the SCAN key is at High level, calls the memorized stations sequentially. (Max 10 station) When not using the SCAN key, set pin 27 to Low.	
32	$\overline{\text{RESET}}$	Reset input	Device system reset signal input pin. While RESET is at Low level, a reset is applied. When RESET reaches High level, the program starts from address 0. Start the program after V _{DD} reaches the specified value.	

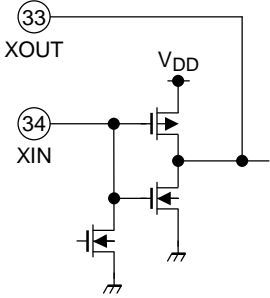
PIN No.	Symbol	Pin Name	Function and Operation	Remarks
33	XOUT	Crystal oscillator pin	Crystal oscillator pin. A reference 75 kHz crystal oscillator pin is connected to the XIN and XOUT pins.	
34	XIN			

Application Note

1. FM detection circuit

For the FM detection circuit, detection coil is able to use instead of ceramic discriminator. Recommended circuit and recommended coil are as follows.

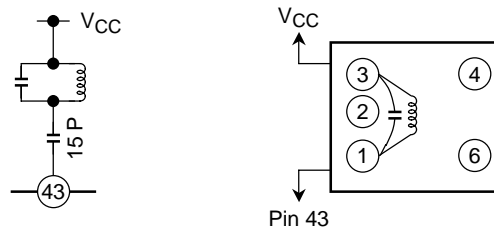

Test Frequency	Co (pF)	Qo	Turns				Wire (mmφ)	Reference
			1-2	2-3	1-3	4-6		
10.7 MHz	51	45	—	—	30	—	0.08UEW	TOKO Co., Ltd. 600BEAS-10018Z

2. Forced manual switch

- Forced manual switchover is done by pin 47
- As the figure below shows, when the electronic switch uses a transistor, keep V_{CE} (sat, saturated voltage between the collector and emitter) up to 0.2 V. At this time, if the voltage on pin 47 exceeds 0.2 V or the current from the pin drops below 30 μ A ($V_{CC} = 3$ V typ.), Forced Monaural may not be set.

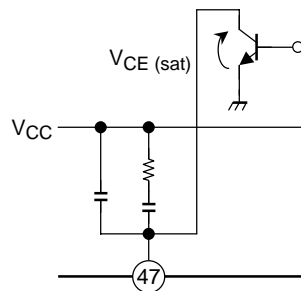

3. Vcc line

The tuner have two voltage supply terminals, V_{CC} (for AM, FM IF, MPX stage) and RF V_{CC} (for FM RF stage). Set up the potential difference between V_{CC} and RF V_{CC} 0.4 V (typ.) or less, otherwise there is the case that this IC doesn't operate normally.

4. How to control the Divider of FM OSC.

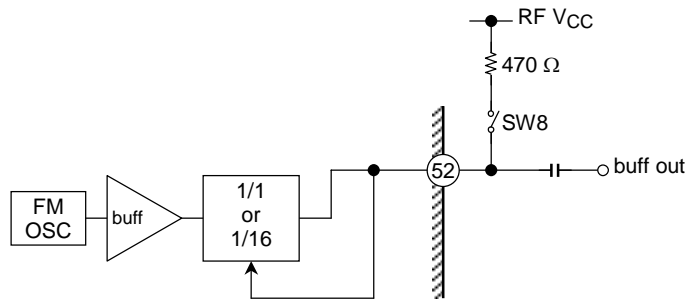

Divider of FM OSC ON/OFF switching is controlled by external pull-up resistor of pin 52. In case of Divider of FM OSC is used, it is necessary to set up the value of R under 470 Ω (typ.). When R is over 470 Ω, it is feared that Divider is not operating. (At this time, buffer output frequency is equal to FM OSC frequency.)

Mode	SW8	Output Frequency	Output Level (typ.)
FM	OPEN	1/1 FM OSC	35 mVrms
	ON	1/16 FM OSC	110 mVrms

Note 1: The 1/16 FM OSC is used to set the combination of the tuner and PLL. When combining the tuner and PLL using the IC, do not select the 1/1 FM OSC.

5. IF Count Flow

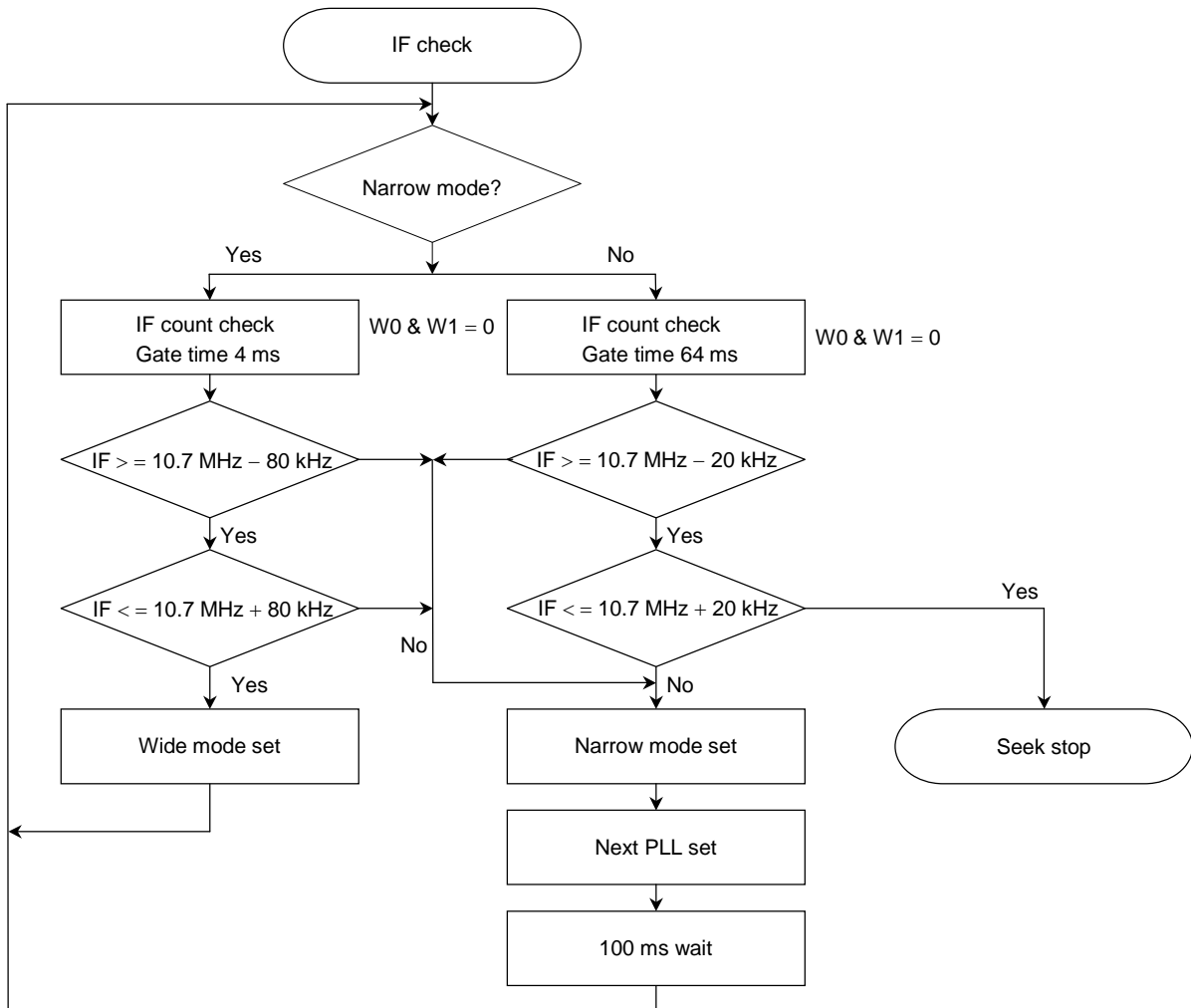

6. Setting Constants of External Devices for the Crystal Oscillator Circuit

When determining the required capacitance values of the external components, please send a PCB of the finalized layout with the ICs mounted on it to the manufacturer of the crystal oscillator for them to test. If necessary, Toshiba can supply ICs with a range of different parasitic capacitance values on request. In addition, please use a crystal oscillator with the lowest possible CI value.

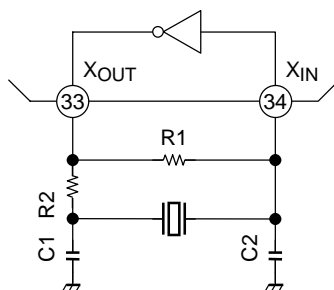

A Daishinku K.K. crystal oscillator (with a maximum CI value of 30 k Ω) was tested with Toshiba's test PCB (using capacitors of 18 pF and 22 pF).

3-Line Bus Specifications

1. Specified radio station data transfer from main microcontroller to tuner microcontroller ($D3_0 < 8$)

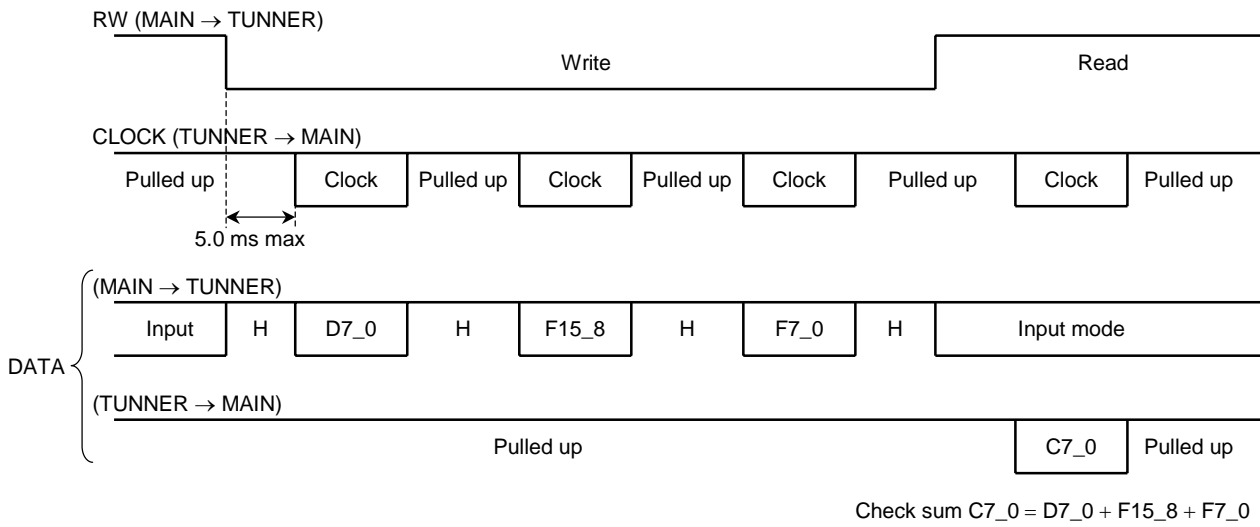

2. Radio station display data transfer from tuner microcontroller to main microcontroller ($D3_0 \geq 8$)

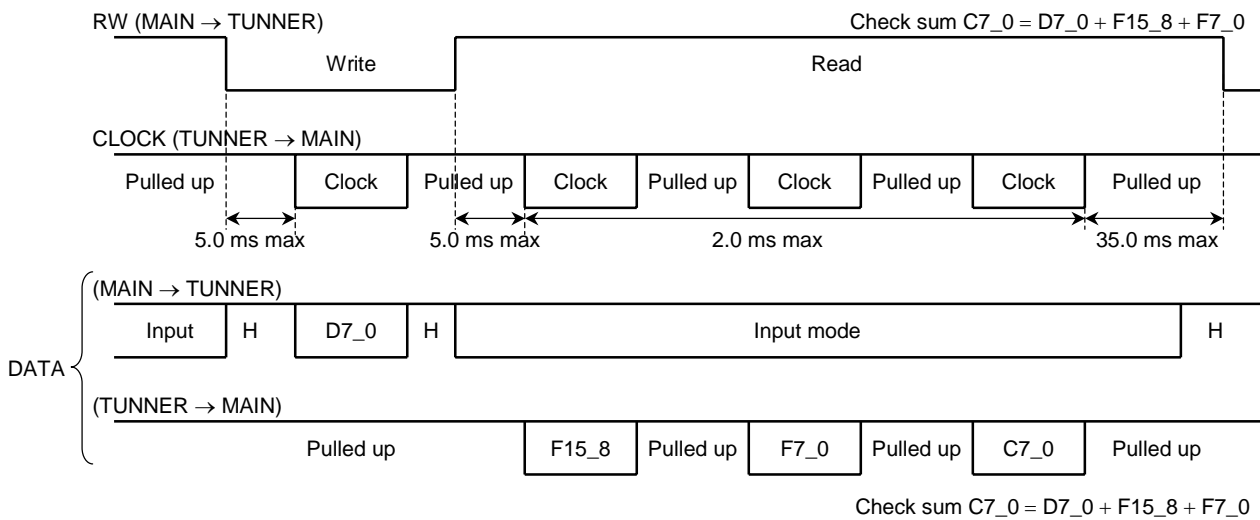

3. Clock and data timing

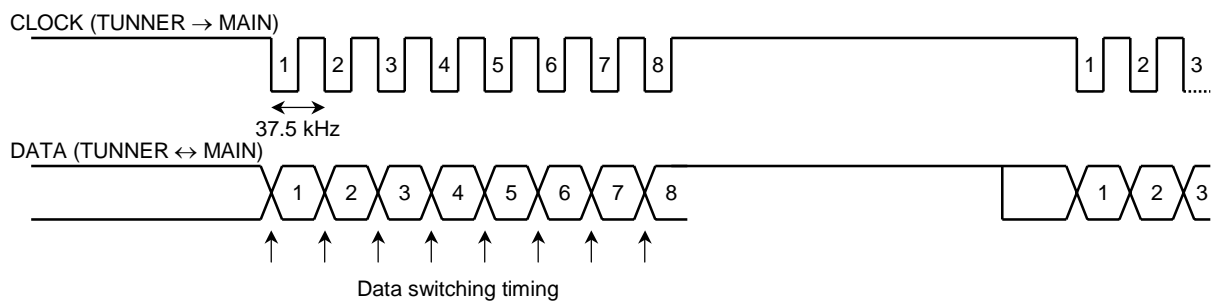

D7: 0 fixed

D7	0
----	---

D6: NG bit

The main microcontroller verifies the D6 bit using the check sum of data sent from the tuner microcontroller. If D6 is NG, the main microcontroller sets the D6 bit to 1 (NG) and resends it to the tuner microcontroller within 10 ms. After receiving D6 bit = 1, the tuner microcontroller invalidates D6 = 1 which was received before the resent D6 = 1. Thus, the resent data are updated 10 ms later.

D6	NG bit
0	OK
1	NG

D5: POWER

Used to hold the internal data with the tuner in standby state (crystal oscillator in low-current dissipation mode). Linked to pin 24, I/O port (at power on: Low output, at standby: OPEN output).

D5	POWER	Pin 24
0	OFF	OPEN
1	ON	L

D4: STEREO

Used to set OUT port for switching between stereo and monaural. Linked to pin 9, I/O port (Forced monaural: Low output, Stereo: OPEN output)

D4	STEREO/MONO
0	STEREO
1	MONO

Setting Formats

D3	D2	D1	D0	Command
0	0	0	0	Search stop and PLL set
0	0	0	1	—
0	0	1	0	—
0	0	1	1	—
0	1	0	0	—
0	1	0	1	PLL set and down search
0	1	1	0	PLL set and up search
0	1	1	1	—
1	0	0	0	Search stop
1	0	0	1	1 step down
1	0	1	0	1 step up
1	0	1	1	—
1	1	0	0	—
1	1	0	1	Down search
1	1	1	0	Up search
1	1	1	1	Frequency data load

F15~F12

1. Main microcontroller to tuner microcontroller

F15	F14	F13	F12
D3	D2	D1	D0

2. Tuner microcontroller to main microcontroller

F14	Search State
0	STOP
1	BUSY

F15/F13/F12: 0 fixed

F15	F13	F12
0	0	0

F11~F0

Radio station formats

				F11_F8	F7_F4	F3_F0
0	0	0	0	—	0	0.0
0	0	0	1	—	1	0.1
0	0	1	0	—	2	0.2
0	0	1	1	—	3	0.3
0	1	0	0	—	4	0.4
0	1	0	1	—	5	0.5
0	1	1	0	60	6	0.6
0	1	1	1	70	7	0.7
1	0	0	0	80	8	0.8
1	0	0	1	90	9	0.9
1	0	1	0	100	—	—
1	0	1	1	60 + 50 k	—	—
1	1	0	0	70 + 50 k	—	—
1	1	0	1	80 + 50 k	—	—
1	1	1	0	90 + 50 k	—	—
1	1	1	1	100 + 50 k	—	—

UART Specifications

When sending frequency data from PC (D3_0 < 8)

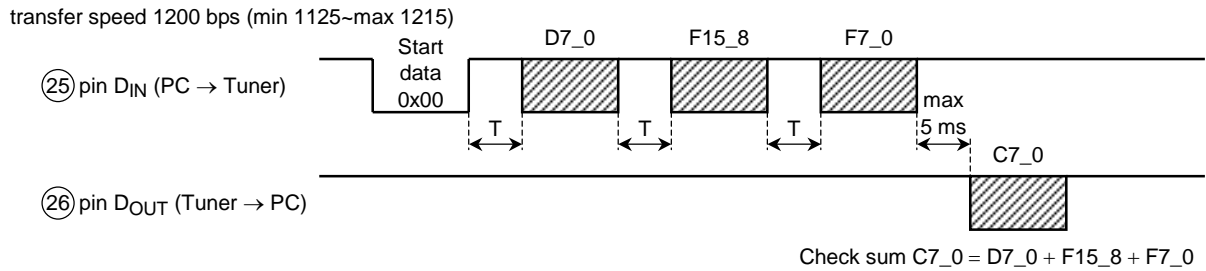

When sending frequency data from tuner microcontroller (D3_0 >= 8)

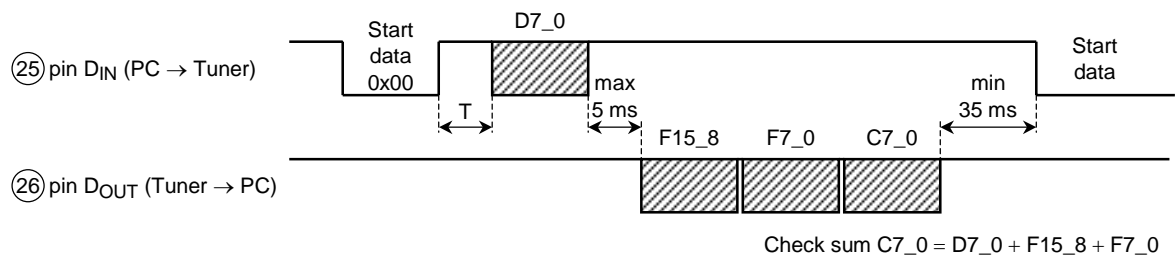

- If the next 1-byte data are not sent within T: 20 ms, an error occurs.
- 0x00 must be sent as start data.
- Command data used for communications are the same as commands used for communications between the main and tuner microcontrollers.

Test circuit coil data

(1) Wide V_T range

Coil No.	Test Freq	L (μH)	Co (pF)	Q ₀	Turns					Wire (mmφ)	Reference
					1-2	2-3	1-3	1-4	4-6		
L ₁ FM RF	100 MHz	—	—	79	—	—	2 $\frac{1}{2}$	—	—	0.16UEW	TOKO Co., Ltd. 666SNF-305NK
L ₂ FM OSC	100 MHz	—	—	76	—	—	2	—	—	0.16UEW	TOKO Co., Ltd. 666SNF-306NK

(2) Narrow V_T range (Eur. and U.S.A. band)

Coil No.	Test Freq	L (μH)	Co (pF)	Q ₀	Turns					Wire (mmφ)	Reference
					1-2	2-3	1-3	1-4	4-6		
L ₁ FM RF	100 MHz z	—	33.4	61	—	—	3	—	—	0.09 2UEW	TOKO Co., Ltd. 657AN-1609
L ₂ FM OSC	100 MHz z	—	40.2	67	—	—	3	—	—	0.08 2UEW	TOKO Co., Ltd. 657AN-1608

(3) Narrow VT range (Japan band)

Coil No.	Test Freq	L (μH)	Co (pF)	Qo	Turns					Wire (mmφ)	Reference
					1-2			1-4	4-6		
L ₁ FM RF	100 MHz z	—	24.9	66	—	—	4	—	—	0.09 2UEW	TOKO Co., Ltd. 657AN-1611
L ₂ FM OSC	100 MHz z	—	17.9	69	—	—	5	—	—	0.09 2UEW	TOKO Co., Ltd. 657AN-1610

L₁: FM RF

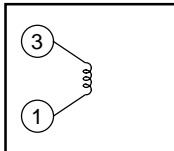

L₂: FM OSC

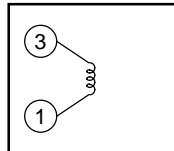

Maximum Ratings (Ta = 25°C)

Characteristics		Symbol	Rating	Unit
Tuner	Supply voltage	V _{CC}	8	V
	LED current	I _{LED}	10	mA
	LED voltage	V _{LED}	8	V
PLL micro-controller	Supply voltage	V _{DD}	-0.3~4.0	V
	Output withstanding voltage 1 (N-ch open-drain) (Note 2)	V _{O1}	-0.3~V _{DD} + 0.3	
	Output withstanding voltage 2 (N-ch open-drain) (Note 3)	V _{O2}	-0.3~4.0	
	Input voltage	V _{IN}	-0.3~V _{DD} + 0.3	
Power dissipation (Note 4)		P _D	700	mW
Operating temperature		T _{opr}	-10~60	°C
Storage temperature		T _{stg}	-55~150	°C

Note 2: 7 pin IF-count, 8 pin TEST1, 9 pin AREA

Note 3: 24 pin Tuner power pin

Note 4: Power consumption is rated at 25°C. At temperatures higher than 25°C, power consumption is decreased by 7 mW per °C.

Electrical Characteristics

1. Tuner

(unless otherwise specified, $T_a = 25^\circ\text{C}$, $V_{CC} = 3\text{ V}$, F/E : $f = 98\text{ MHz}$, $f_m = 1\text{ kHz}$
 FM IF: $f = 10.7\text{ MHz}$, $\Delta f = \pm 75\text{ kHz}$,
 $f_m = 1\text{ kHz}$
 MPX : $f_m = 1\text{ kHz}$)

Characteristics		Symbol	Test Circuit	Test Condition	Min	Typ.	Max	Unit	
Supply current		I_{CC} (FM)	—	$V_{in} = 0$, FM mode	—	15	19	mA	
F/E	Input limiting voltage	V_{in} (lim)	—	$V_{in} = 60\text{ dB}\mu\text{V}$ EMF, -3 dB limiting	—	12	—	$\text{dB}\mu\text{V}$ EMF	
FM IF	Input limiting voltage	V_{in} (lim) IF	—	$V_{in} = 80\text{ dB}\mu\text{V}$ EMF, -3 dB limiting	35	40	45	$\text{dB}\mu\text{V}$ EMF	
	Recovered output voltage	V_{OD}	—	$V_{in} = 80\text{ dB}\mu\text{V}$ EMF	200	250	300	mVrms	
	Signal to noise ratio	S/N	—	$V_{in} = 80\text{ dB}\mu\text{V}$ EMF	—	75	—	dB	
	Total harmonic distortion	THD	—	$V_{in} = 80\text{ dB}\mu\text{V}$ EMF	—	0.3	—	%	
	AM rejection ration	AMR	—	$V_{in} = 80\text{ dB}\mu\text{V}$ EMF	—	60	—	dB	
	IF count output frequency	f_{IF} (FM)	—	$V_{in} = 80\text{ dB}\mu\text{V}$ EMF	1.3373	1.3375	1.3377	MHz	
	IF count output voltage	V_{IF} (FM)	—	$V_{in} = 80\text{ dB}\mu\text{V}$ EMF	200	260	—	mV _{p-p}	
IF count output sensitivity	IF sens (FM)	—		46	51	56	$\text{dB}\mu\text{V}$ EMF		
Pin 49 output resistance		R_{50}	—	FM mode	—	0.75	—	$\text{k}\Omega$	
MPX	Input resistance	R_{IN}	—	—	—	55	—	$\text{k}\Omega$	
	Output resistance	R_{OUT}	—	—	—	5	—	$\text{k}\Omega$	
	Max composite signal input voltage	V_{in} MAX (Stereo)	—	L + R = 90%, P = 10%, SW3: LPF ON $f_m = 1\text{ kHz}$, THD = 3%	—	700	—	mVrms	
	Separation	Sep.	—	L + R = 180 mVrms, P = 20 mVrms SW3: LPF ON	$f_m = 100\text{ Hz}$	—	45	—	dB
					$f_m = 1\text{ kHz}$	35	45	—	
					$f_m = 10\text{ kHz}$	—	35	—	
	Total harmonic distortion	Monaural	THD (Monaural)	—	$V_{in} = 200\text{ mVrms}$	—	0.3	—	%
		Stereo	THD (Stereo)	—	L+R = 180 mVrms, P = 20 mVrms, SW3: LPF ON	—	0.35	—	
	Voltage gain		G_V	—	$V_{in} = 200\text{ mVrms}$	-2.8	-1.3	0.2	dB
	Channel balance		C.B.	—	$V_{in} = 200\text{ mVrms}$	-1.5	0	1.5	dB
	Stereo LED sensitivity	ON	V_L (ON)	—	Pilot input (19 kHz)	—	10	14	mVrms
OFF		V_L (OFF)	—	5		8	—		
Stereo LED hysteresis		V_H	—	To LED turn off from LED turn on	—	2	—	mVrms	
Capture range		C.R.	—	P = 15 mVrms	—	± 8	—	%	
Signal noise ratio		S/N	—	$V_{in} = 200\text{ mVrms}$	—	80	—	dB	
Muting attenuation		MUTE	—	$V_{in} = 200\text{ mVrms}$	—	70	—	dB	

2. PLL microcontroller (Unless otherwise noted, Ta = 25°C, VDD = 3.0 V)

Characteristics	Symbol	Test Circuit	Test Condition	Min	Typ.	Max	Unit
Range of operating supply voltage	V _{DD1}	—	Under CPU operation (Note 4)	1.8	~	3.6	V
	V _{DD2}	—	Under PLL operation (Note 4)	1.8	~	3.6	
Range of memory retention voltage	V _{HD}	—	Crystal oscillation stopped (CKSTP instruction executed) (Note 4)	0.75	~	3.6	V
Range of operating supply voltage	I _{DD1}	—	PLL operation (LPF mode) at input 15 MHz.	—	—	1.3	mA
	I _{DD2}	—	Power OFF at transmission mode (PLL OFF, CPU ON, X'tal ON)	—	40	60	μA
	I _{DD3}	—	Power OFF at No-transmission mode (PLL OFF, CPU OFF, X'tal ON)	—	20	30	μA
Memory retention current	I _{HD}	—	SLEEP = "L" (PLL OFF, CPU OFF, X'tal OFF)	—	0.1	1.0	μA
Crystal oscillation frequency	f _{XT}	—	(Note 4)	—	75	—	kHz
Crystal oscillation start-up time	t _{st}	—	Crystal oscillation f _{XT} = 75 kHz	—	—	1.0	s

Note 4: Guaranteed when V_{DD} = 1.8~3.6 V, Ta = -10~60°C

24 pin tuner power output, 25 pin RW (D_{IN}), 26 pin DATA (D_{OUT}), 27 pin CLOCK/SCAN

Characteristics	Symbol	Test Circuit	Test Condition	Min	Typ.	Max	Unit	
Output current	"L" level	I _{OL1}	—	V _{OL} = 0.3 V	1.4	2.8	—	mA
Input leak current		I _{LI}	—	V _{IH} = 3.6 V, V _{IL} = 0 V	—	—	±1.0	μA
Input voltage	"H" level	V _{IH1}	—	—	V _{DD} × 0.8	~	3.6	V
	"L" level	V _{IL1}	—	—	0	~	V _{DD} × 0.2	

7 pin IF count output, 8 pin TEST1 input, 9 pin AREA input

Characteristics	Symbol	Test Circuit	Test Condition	Min	Typ.	Max	Unit	
Output current	"L" level	I _{OL1}	—	V _{OL} = 0.3 V	1.4	2.8	—	mA
Input leak current		I _{LI}	—	V _{IH} = V _{DD} , V _{IL} = 0 V	—	—	±1.0	μA
Input voltage	"H" level	V _{IH1}	—	—	V _{DD} × 0.8	~	V _{DD}	V
	"L" level	V _{IL1}	—	—	0	~	V _{DD} × 0.2	

10 pin Basdis input, 11 pin Up key input, 12 pin input, 14 pin Beep output, 15 pin I/O

Characteristics		Symbol	Test Circuit	Test Condition	Min	Typ.	Max	Unit
Output current	"H" level	I_{OH1}	—	$V_{DD} = 1.5\text{ V}$, $V_{OH} = V_{DD} - 0.2\text{ V}$	-1.5	-3.0	—	mA
	"L" level	I_{OL1}	—	$V_{OL} = 0.3\text{ V}$	1.4	2.8	—	
Input leak current		I_{LI}	—	$V_{IH} = V_{DD}$, $V_{IL} = 0\text{ V}$	—	—	± 1.0	μA
Input Voltage	"H" level	V_{IH1}	—	—	$V_{DD} \times 0.8$	~	V_{DD}	V
	"L" level	V_{IL}	—	—	0	~	$V_{DD} \times 0.2$	
Input pull-up/pull down register		R_{IN1}	—	When I/O port P1 is set to pull-up or pull-down. (UP key, TEL key)	30	60	120	$\text{k}\Omega$

Mute Output

Characteristics		Symbol	Test Circuit	Test Condition	Min	Typ.	Max	Unit
Output current	"H" level	I_{OH1}	—	$V_{OH} = V_{DD} - 0.3\text{ V}$	-1.5	-3.0	—	mA
	"L" level	I_{OL1}	—	$V_{OL} = 0.3\text{ V}$	1.4	2.8	—	

SLEEP, RESET Input

Characteristics		Symbol	Test Circuit	Test Condition	Min	Typ.	Max	Unit
Input leak current		I_{LI}	—	$V_{IH} = V_{DD}$, $V_{IL} = 0\text{ V}$	—	—	± 1.0	μA
Input voltage	"H" level	V_{IH3}	—	—	$V_{DD} \times 0.8$	~	V_{DD}	V
	"L" level	V_{IL3}	—	—	0	~	$V_{DD} \times 0.2$	

DO Output

Characteristics		Symbol	Test Circuit	Test Condition	Min	Typ.	Max	Unit
Output voltage	"H" level	I_{OH1}	—	$V_{OH} = V_{DD} - 0.3\text{ V}$	-1.0	-2.0	—	mA
	"L" level	I_{OL1}	—	$V_{OH} = 0.3\text{ V}$	1.4	2.8	—	
Output off leak voltage		I_{TL}	—	$V_{DD} = 1.5\text{ V}$, $V_{TLH} = 1.5\text{ V}$ $V_{TLL} = 0\text{ V}$	—	—	± 100	nA

Others

Characteristics		Symbol	Test Circuit	Test Condition	Min	Typ.	Max	Unit
Input pull-down resistance		R_{IN2}	—	(TEST 2)	5	10	30	$\text{k}\Omega$
Input amp. feedback resistance		R_{fIN1}	—	LF mode (OSCin)	300	600	1200	$\text{k}\Omega$
		R_{fIN2}	—	(IFin)	300	600	1200	

1. Narrow V_T range ($V_T = 1.05$ to 2.11 V)

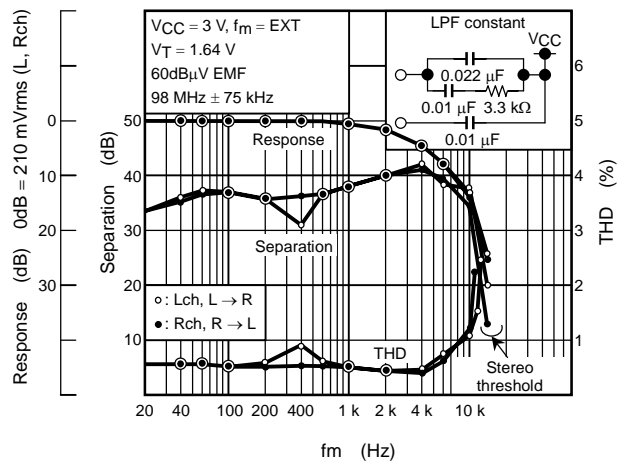
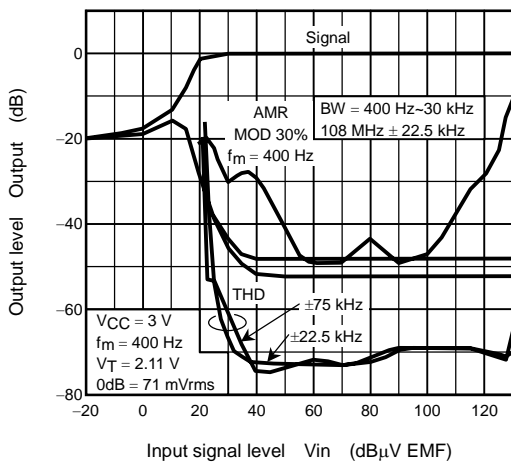
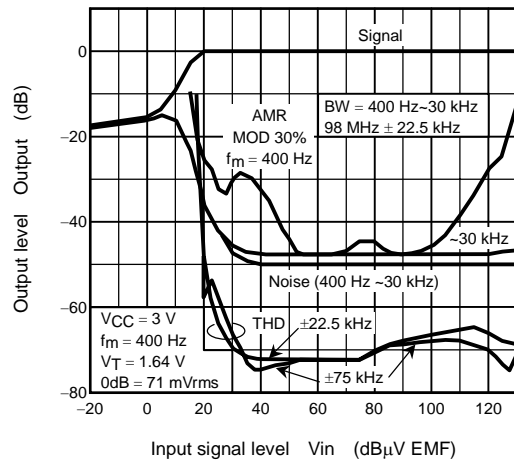
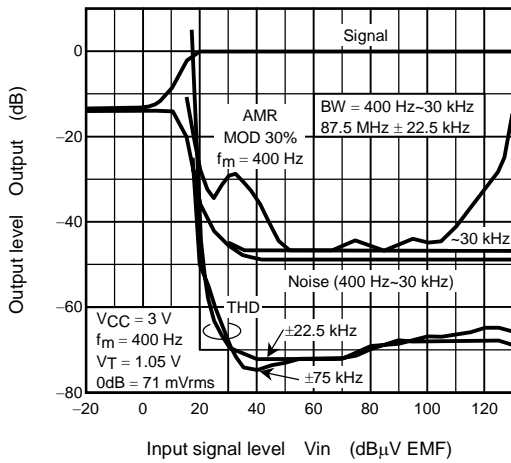
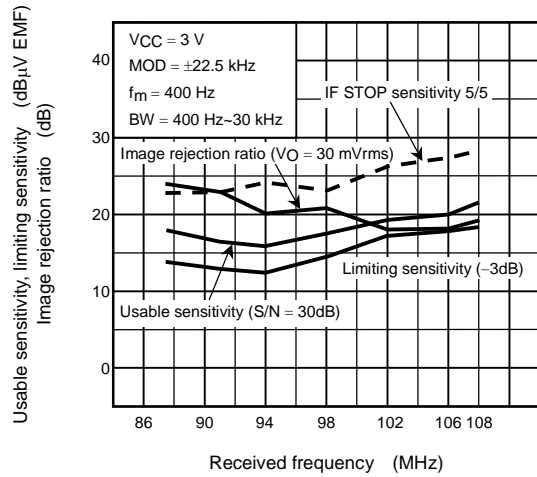
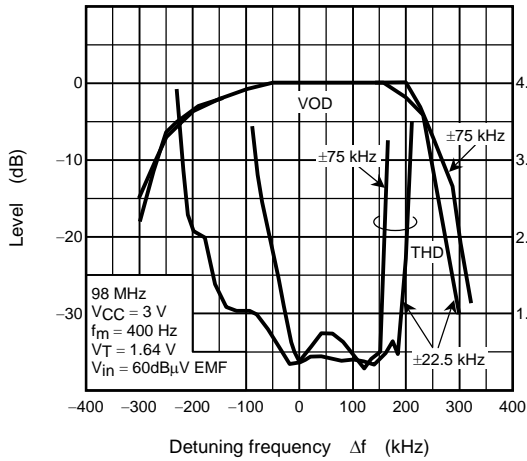

2. Wide V_T range ($V_T = 3.04$ to 7.81 V)

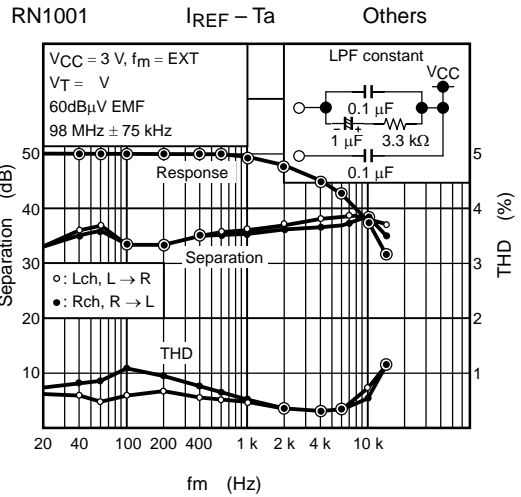
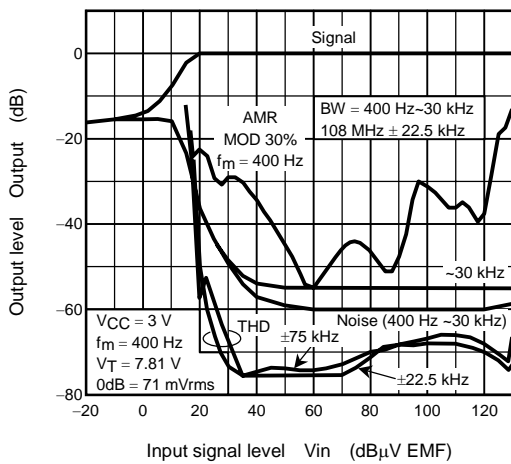
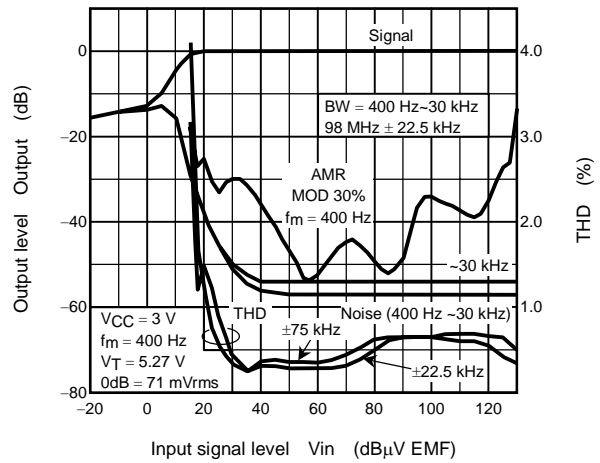
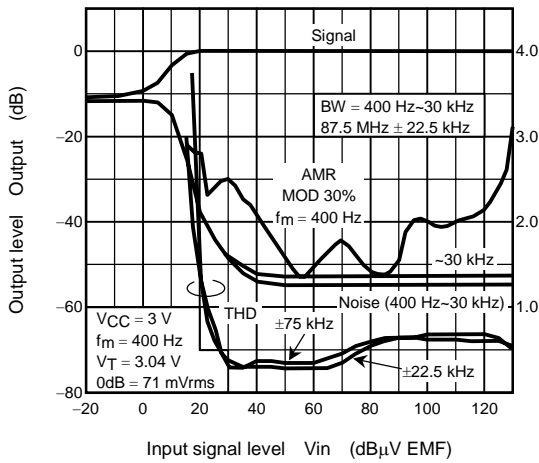
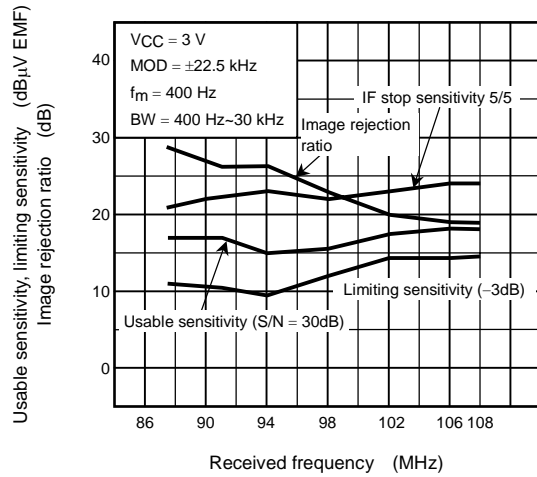
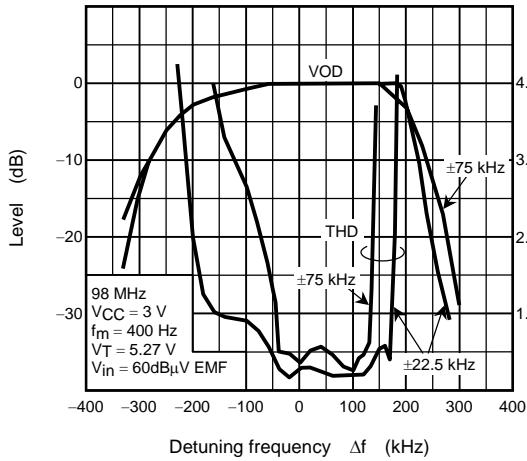

Application Circuit

Transmission mode specifications: BUS dis (pin 10) = Low

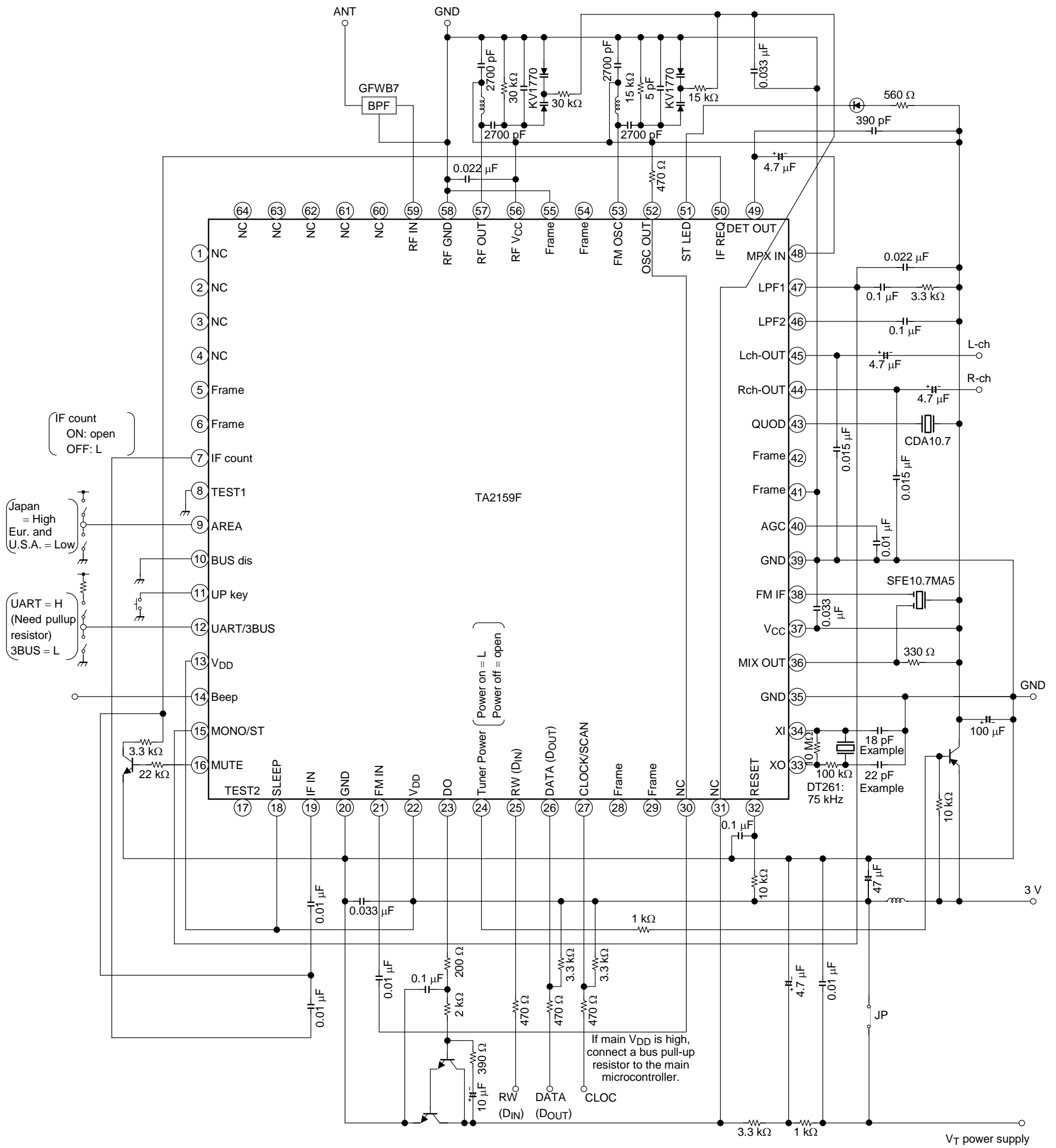

Application Circuit

No-Transmission mode specifications: BUS dis (pin 10) = High

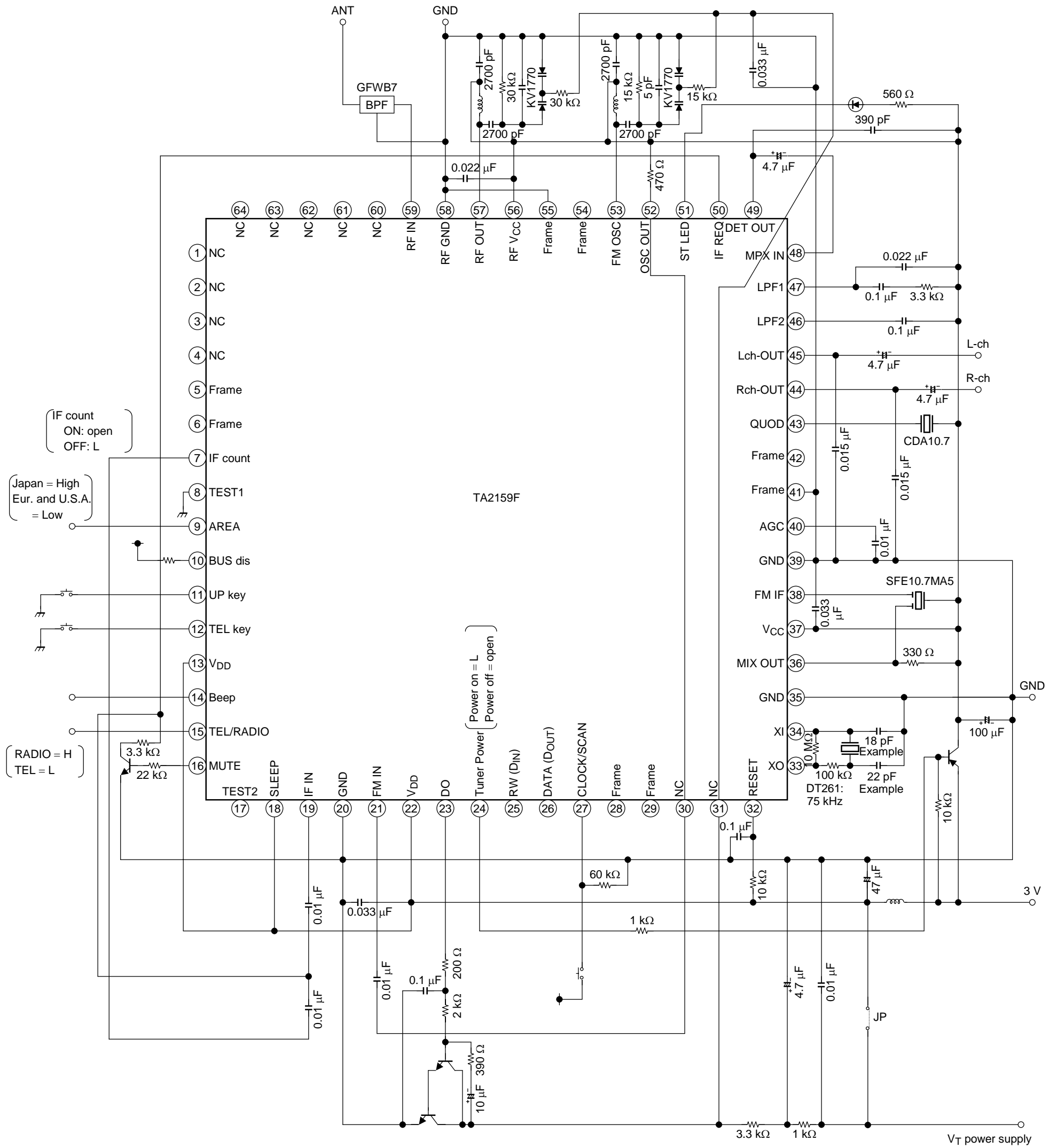

Package Dimensions

QFP64-P-1010-0.50C

Unit : mm

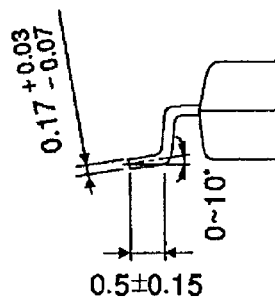
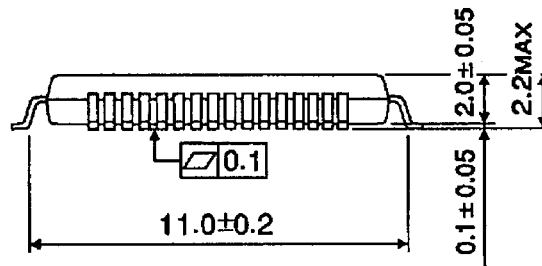
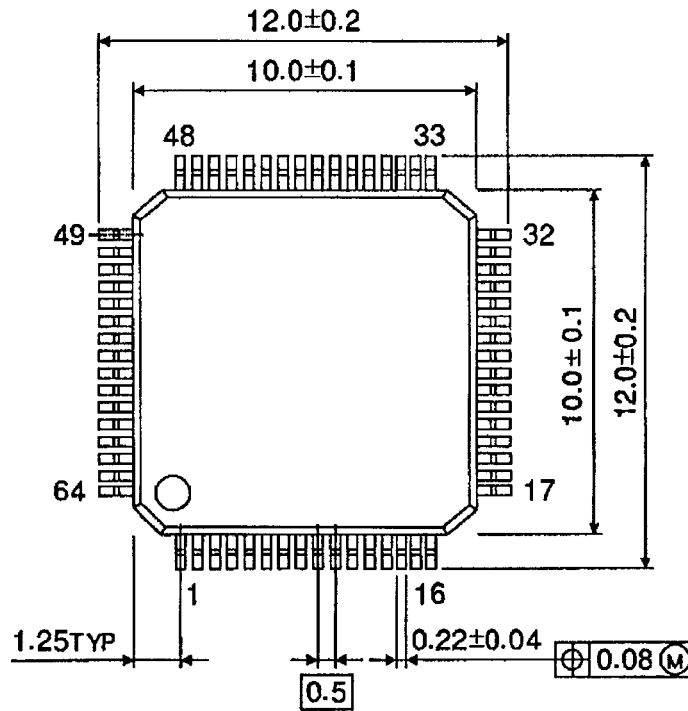

Weight: 0.48 g (typ.)

RESTRICTIONS ON PRODUCT USE

000707EBA

- TOSHIBA is continually working to improve the quality and reliability of its products. Nevertheless, semiconductor devices in general can malfunction or fail due to their inherent electrical sensitivity and vulnerability to physical stress. It is the responsibility of the buyer, when utilizing TOSHIBA products, to comply with the standards of safety in making a safe design for the entire system, and to avoid situations in which a malfunction or failure of such TOSHIBA products could cause loss of human life, bodily injury or damage to property.
In developing your designs, please ensure that TOSHIBA products are used within specified operating ranges as set forth in the most recent TOSHIBA products specifications. Also, please keep in mind the precautions and conditions set forth in the "Handling Guide for Semiconductor Devices," or "TOSHIBA Semiconductor Reliability Handbook" etc..
- The TOSHIBA products listed in this document are intended for usage in general electronics applications (computer, personal equipment, office equipment, measuring equipment, industrial robotics, domestic appliances, etc.). These TOSHIBA products are neither intended nor warranted for usage in equipment that requires extraordinarily high quality and/or reliability or a malfunction or failure of which may cause loss of human life or bodily injury ("Unintended Usage"). Unintended Usage include atomic energy control instruments, airplane or spaceship instruments, transportation instruments, traffic signal instruments, combustion control instruments, medical instruments, all types of safety devices, etc.. Unintended Usage of TOSHIBA products listed in this document shall be made at the customer's own risk.
- The products described in this document are subject to the foreign exchange and foreign trade laws.
- The information contained herein is presented only as a guide for the applications of our products. No responsibility is assumed by TOSHIBA CORPORATION for any infringements of intellectual property or other rights of the third parties which may result from its use. No license is granted by implication or otherwise under any intellectual property or other rights of TOSHIBA CORPORATION or others.
- The information contained herein is subject to change without notice.