

**STK4171V**

## AF Power Amplifier (Split Power Supply) (40W + 40W min, THD = 0.08%)

### Features

- Pin-compatible with the STK4102II series. The STK4101V series use the same package and are available for output 15W to 50W.
- Built-in muting circuit to cut off various kinds of pop noise
- Greatly reduced heat sink due to substrate temperature 125°C guaranteed
- Distortion 0.08% due to current mirror circuit
- Excellent cost performance

### Package Dimensions

unit: mm

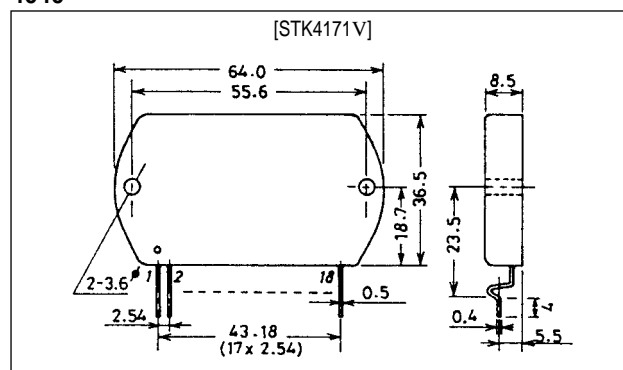
**4040**

### Specifications

**Maximum Ratings** at  $T_a = 25^\circ\text{C}$

Parameter	Symbol	Conditions	Ratings	Unit
Maximum supply voltage	$V_{CC \text{ max}}$		$\pm 49$	V
Thermal resistance	$\theta_{j-c}$		1.8	$^\circ\text{C/W}$
Junction temperature	$T_j$		150	$^\circ\text{C}$
Operating substrate temperature	$T_c$		125	$^\circ\text{C}$
Storage temperature	$T_{\text{stg}}$		-30 to +125	$^\circ\text{C}$
Available time for load short-circuit	$t_s^*1$	$V_{CC} = \pm 32.5\text{V}, R_L = 8\Omega, f = 50\text{Hz}, P_o = 40\text{W}$	2	s

**Recommended Operating Conditions** at  $T_a = 25^\circ\text{C}$

Parameter	Symbol	Conditions	Ratings	Unit
Recommended supply voltage	$V_{CC}$		$\pm 32.5$	V
Load resistance	$R_L$		8	$\Omega$

**Operating Characteristics** at  $T_a = 25^\circ\text{C}$ ,  $V_{CC} = \pm 32.5\text{V}$ ,  $R_L = 8\Omega$ ,  $V_G = 40\text{dB}$ ,  $R_g = 600\Omega$ ,  
 $R_L$  : non-inductive load

Parameter	Symbol	Conditions	min	typ	max	Unit
Quiescent current	$I_{CCO}$	$V_{CC} = \pm 39\text{V}$	20	40	100	mA
Output power	$P_O(1)$	THD = 0.08%, $f = 20\text{Hz to } 20\text{kHz}$	40			W
	$P_O(2)$	$V_{CC} = \pm 28\text{V}$ , THD = 1.0%, $R_L = 4\Omega$ , $f = 1\text{kHz}$	45			W
Total harmonic distortion	THD	$P_O = 1.0\text{W}$ , $f = 1\text{kHz}$			0.08	%
Frequency response	$f_L, f_H$	$P_O = 1.0\text{W}$ , $+0_{-3}$ dB		20 to 50k		Hz
Input impedance	$r_i$	$P_O = 1.0\text{W}$ , $f = 1\text{kHz}$		55		$k\Omega$
Output noise voltage	$V_{NO} * 2$	$V_{CC} = \pm 39\text{V}$ , $R_g = 10k\Omega$			1.2	mVrms
Neutral voltage	$V_N$	$V_{CC} = \pm 39\text{V}$	-70	0	+70	mV
Muting voltage	$V_M$		-2	-5	-10	V

Notes. For power supply at the time of test, use a constant-voltage power supply unless otherwise specified.

\*1 For measurement of the available time for load short-circuit and output noise voltage, use the specified transformer power supply shown right.

\*2 The output noise voltage is represented by the peak value on rms scale (VTVM) of average value indicating type. For AC power supply, use an AC stabilized power supply (50Hz) to eliminate the effect of flicker noise in AC primary line.

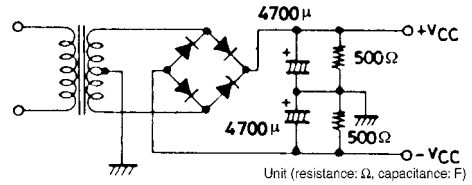

Specified Transformer Power Supply  
(Equivalent to MG-200)

**Equivalent Circuit**

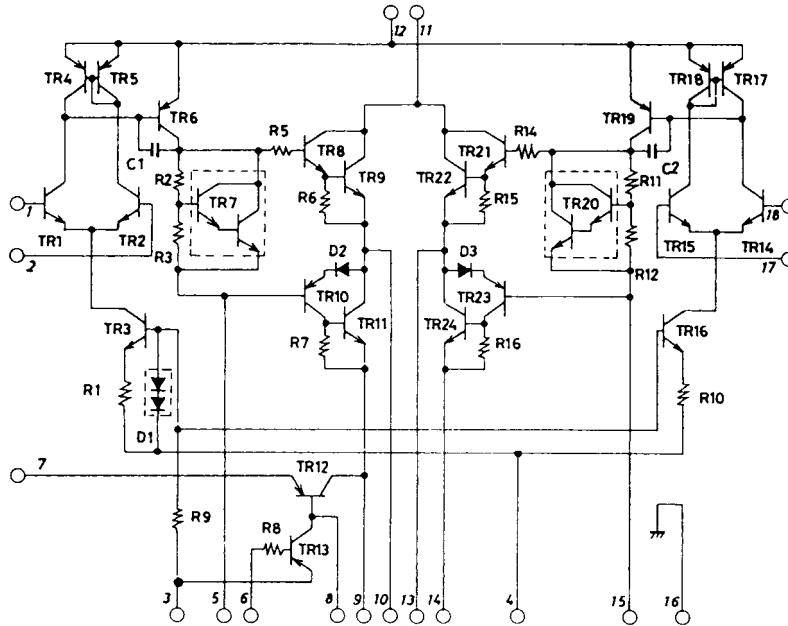

Sample Application Circuit

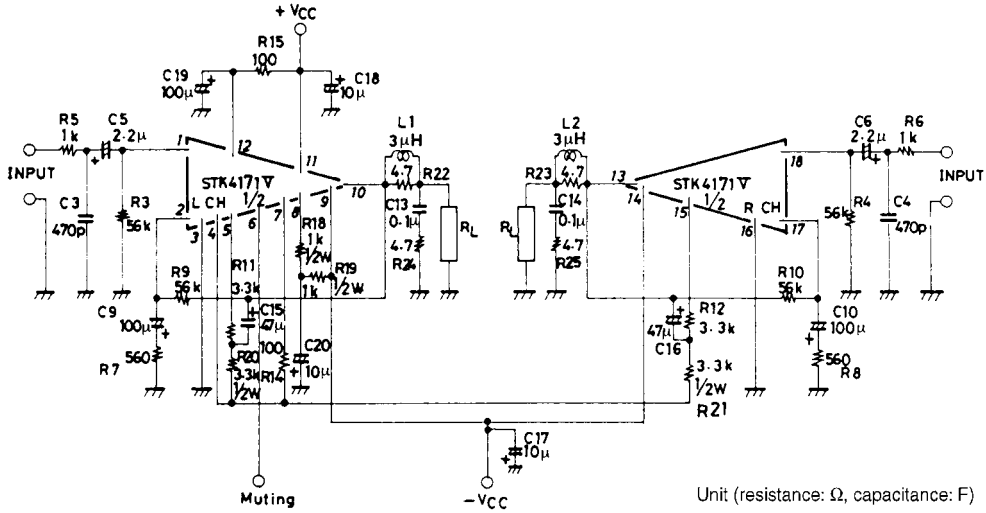

Sample Printed Circuit Pattern for Application Circuit (Cu-foiled side)

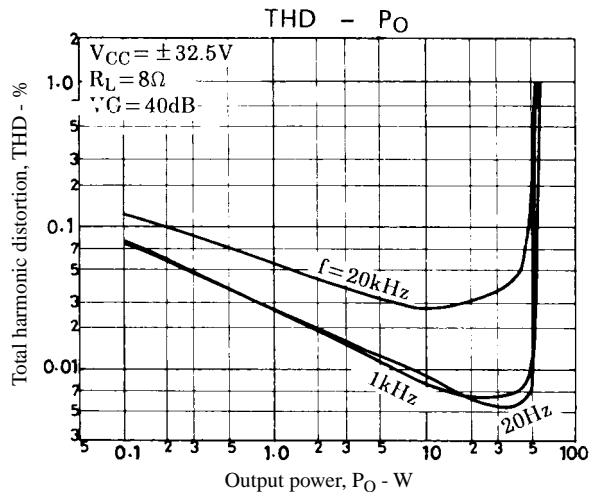
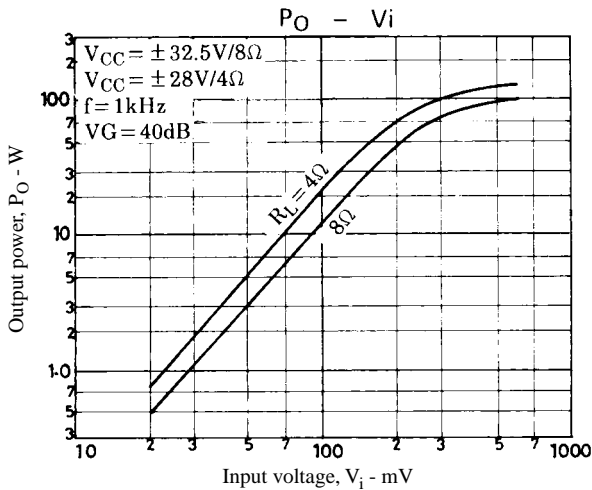
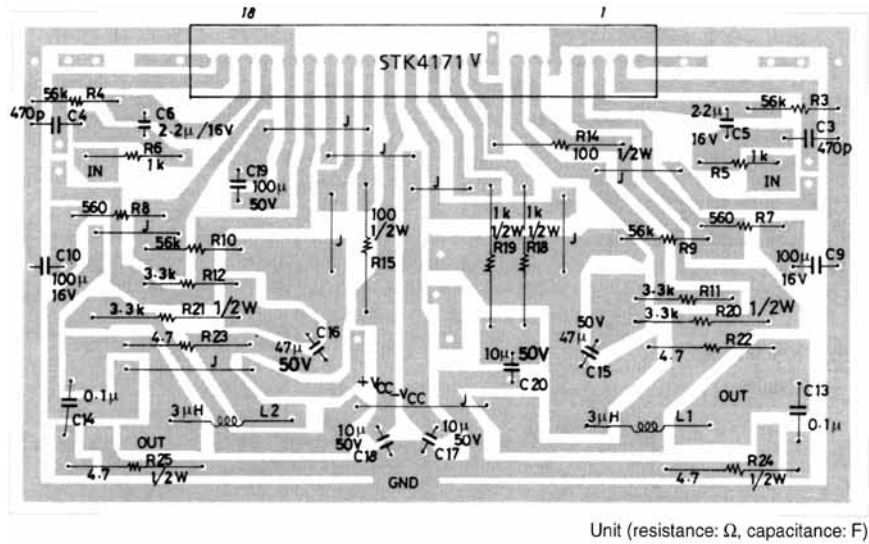

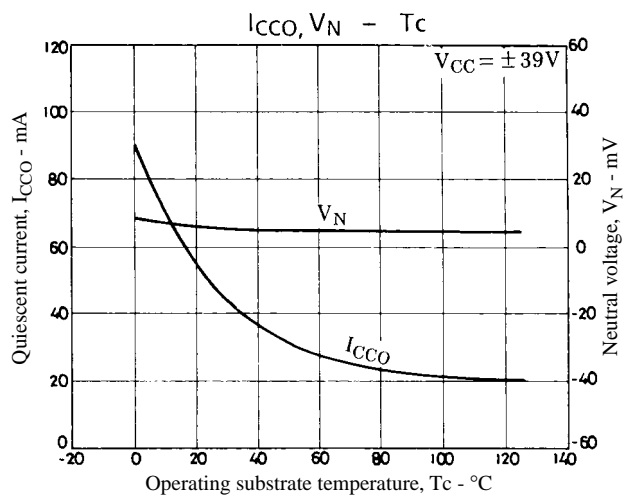
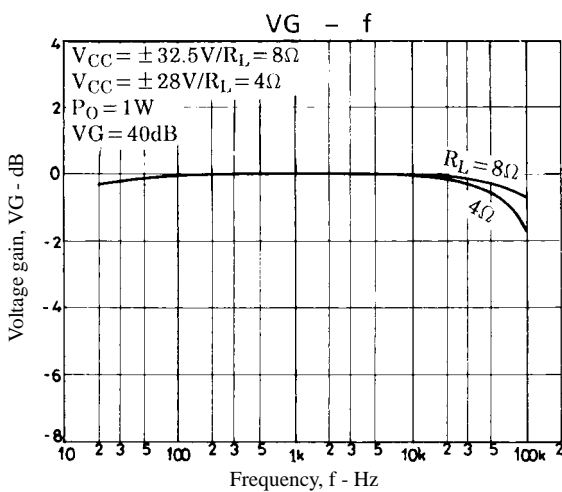
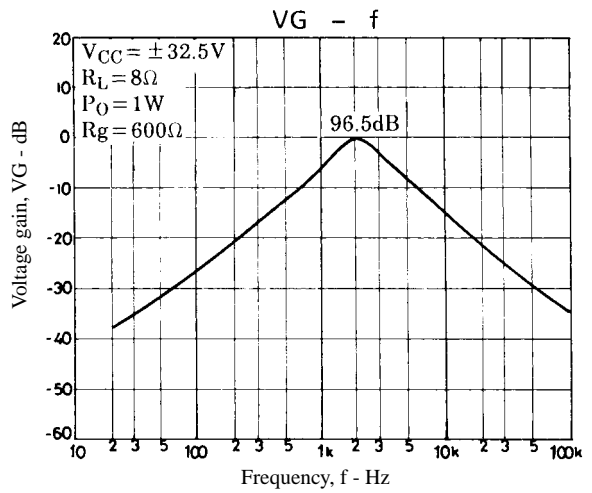
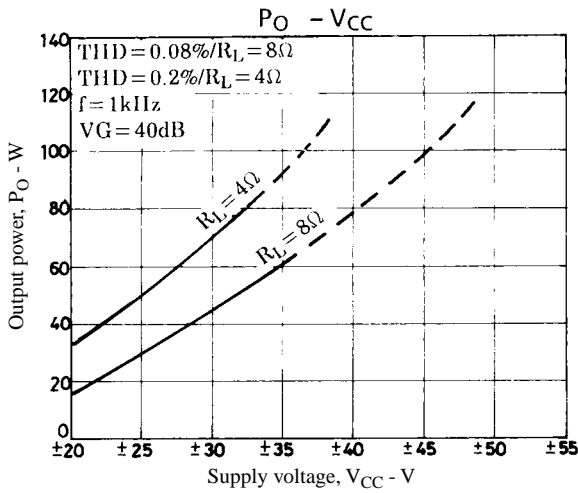
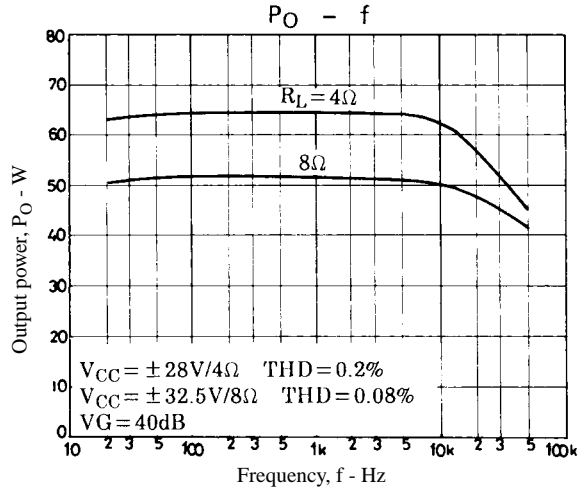
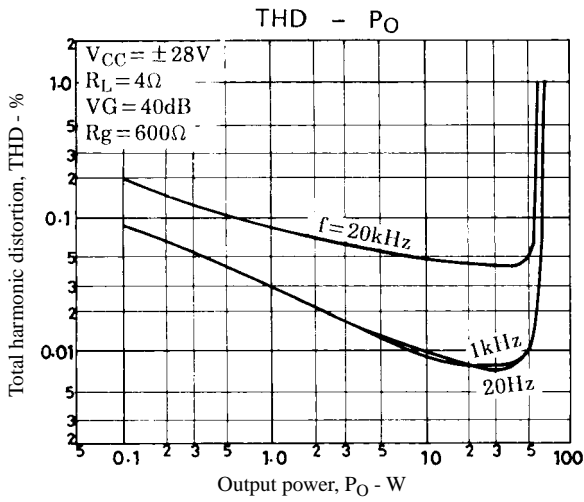

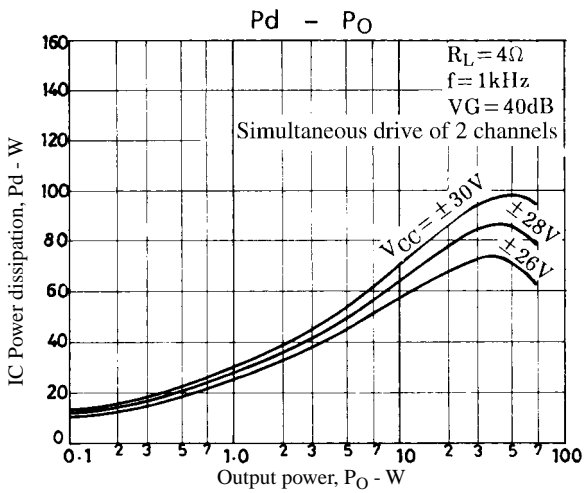
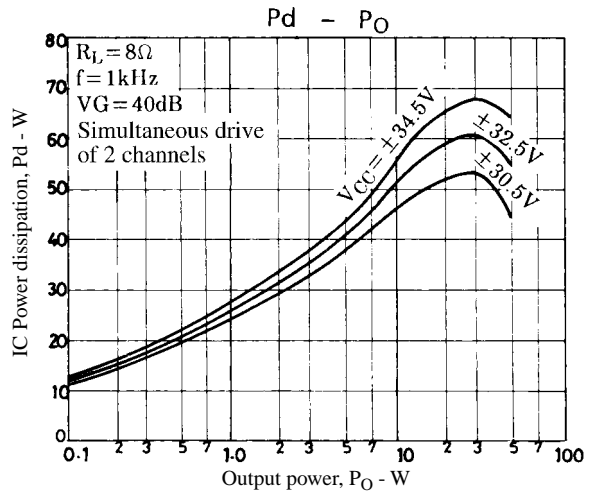
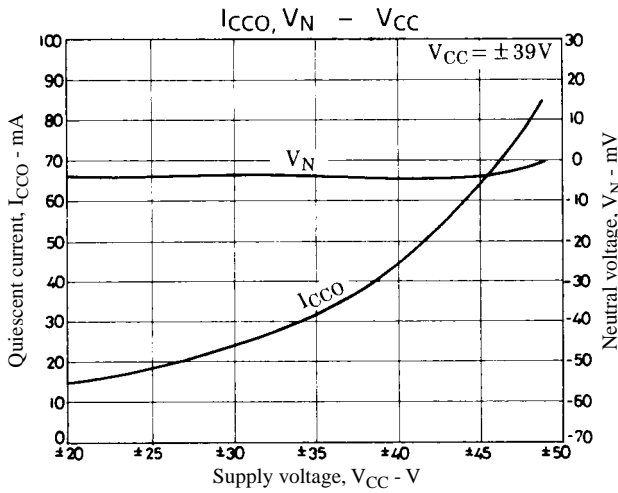

**Description of External Parts**

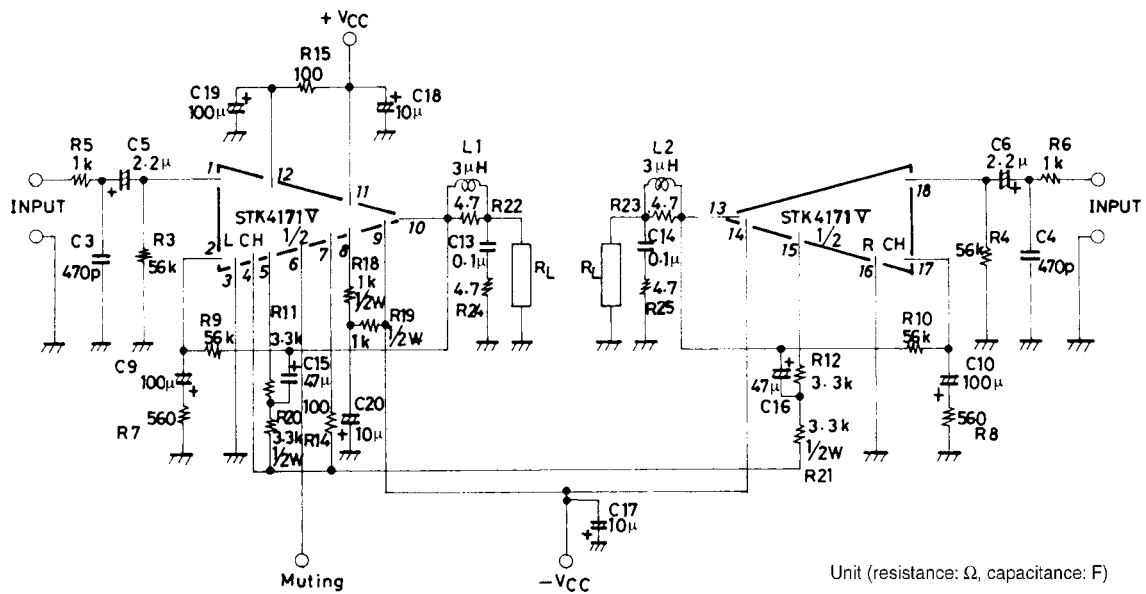

## STK4171V

C3, C4	<p>Input filter capacitors</p> <ul style="list-style-type: none"> <li>• A filter formed with R5 or R6 can be used to reduce noise at high frequencies.</li> </ul>
C5, C6	<p>Input coupling capacitors</p> <ul style="list-style-type: none"> <li>• Used to block DC current. When the reactance of the capacitor increases at low frequencies, the dependence of 1/f noise on signal source resistance causes the output noise to worsen. It is better to decrease the reactance.</li> <li>• To reduce the pop noise at the time of application of power, it is effective to increase C5, C6 that fix the time constant on the input side and to decrease C9, C10 on the NF side.</li> </ul>
C9, C10	<p>NF capacitors</p> <ul style="list-style-type: none"> <li>• These capacitors fix the low cutoff frequency as shown below.</li> </ul> $f_L = \frac{1}{2\pi \cdot C9 \cdot R7} \text{ [Hz]}$ <p>To provide the desired voltage gain at low frequencies, it is better to increase C9. However, do not increase C9 more than needed because the pop noise level becomes higher at the time of application of power.</p>
C19	<p>Decoupling capacitor</p> <ul style="list-style-type: none"> <li>• Used to eliminate the ripple components that mix into the input side from the power line (+V<sub>CC</sub>).</li> </ul>
C15, C16	<p>Bootstrap capacitors</p> <ul style="list-style-type: none"> <li>• When the capacitor value is decreased, the distortion is liable to be higher at low frequencies.</li> </ul>
C17, C18	<p>Oscillation blocking capacitors</p> <ul style="list-style-type: none"> <li>• Must be inserted as close to the IC power supply pins as possible so that the power supply impedance is decreased to operate the IC stably.</li> <li>• Electrolytic capacitors are recommended for C17, C18.</li> </ul>
C20	<p>Capacitor for ripple filter</p> <ul style="list-style-type: none"> <li>• Capacitor for the TR12-used ripple filter in the IC system</li> </ul>
C13	<p>Oscillation blocking capacitor</p> <ul style="list-style-type: none"> <li>• A polyester film capacitor, being excellent in temperature characteristic, frequency characteristic, is recommended for C13.</li> </ul>
R5, R6	Resistors for input filter
R3, R4	<p>Input bias resistors</p> <ul style="list-style-type: none"> <li>• Used to bias the input pin potential to zero. These resistors fix the input impedance practically.</li> </ul>
R7, R9 (R8, R10)	<p>These resistors fix voltage gain VG.</p> <p>It is recommended to use R7 (R8) = 560Ω, R9 (R10) = 56kΩ for VG = 40dB.</p> <ul style="list-style-type: none"> <li>• To adjust VG, it is desirable to change R7 (or R8).</li> <li>• When R7 (or R8) is changed to adjust VG, R3 (=R4) =R9 (=R10) must be set to ensure V<sub>N</sub> balance.</li> </ul>
R11, R20 (R12, R21)	<p>Bootstrap resistors</p> <ul style="list-style-type: none"> <li>• The quiescent current is set by these resistors 3.3kΩ + 3.3kΩ. It is recommended to use this resistor value.</li> </ul>
R15	<p>Resistor for ripple filter</p> <ul style="list-style-type: none"> <li>• (Limiting resistor for predriver TR at the time of load short)</li> </ul>
R14	Used to ensure plus/minus balance at the time of clip.
R18, R19	<p>Resistor for ripple filter</p> <ul style="list-style-type: none"> <li>• When muting TR13 is turned ON, current flows from ground to -V<sub>CC</sub> through TR 13. It is recommended to use 1kΩ (1W) + 1kΩ (1W) allowing for the power that may be dissipated on that occasion.</li> </ul>
R24, R25	Oscillation blocking resistors
R22, R23	Oscillation blocking resistors
L1, L2	Oscillation blocking coils

Sample Application Circuit (protection circuit and muting circuit)

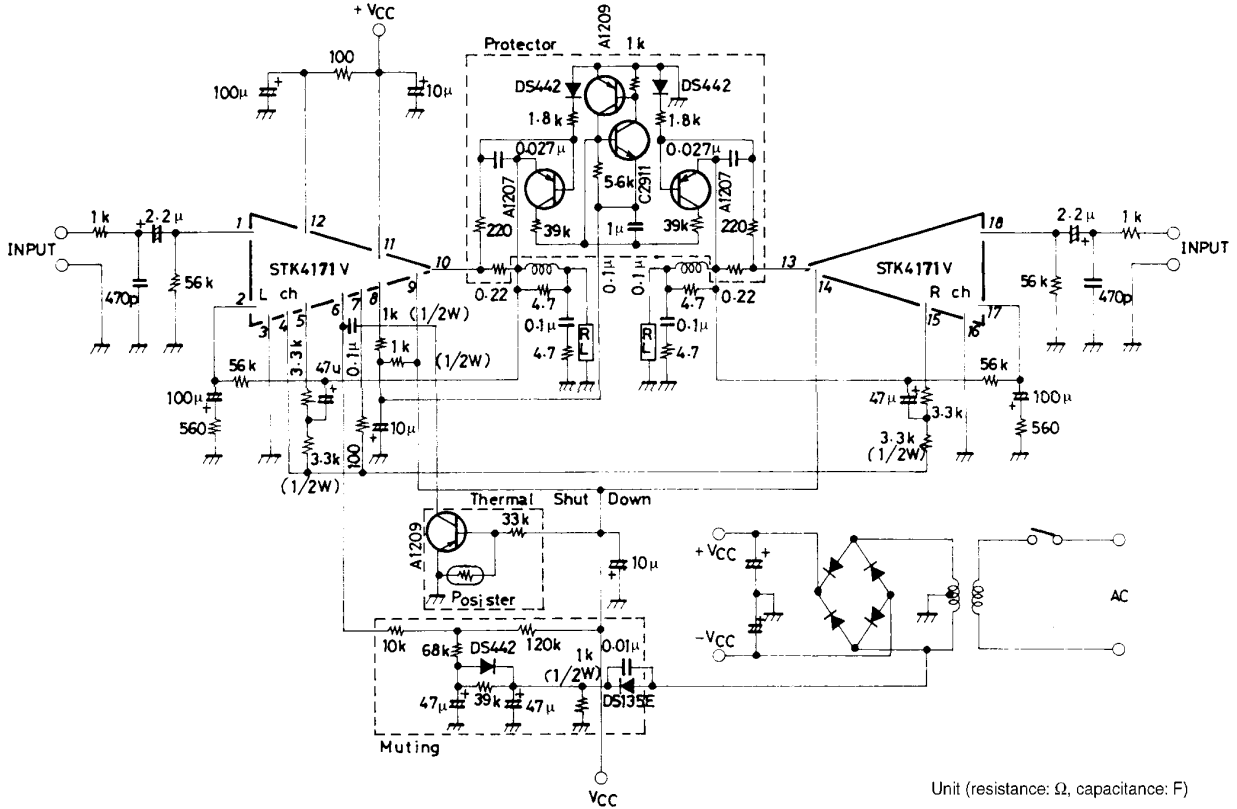

Unit (resistance: Ω, capacitance: F)

Thermal Design

The IC power dissipation of the STK4171V at the IC-operated mode is 61W max. at load resistance 8Ω and 86W max. at load resistance 4Ω (simultaneous drive of 2 channels) for continuous sine wave as shown in Figure 1 and 2.

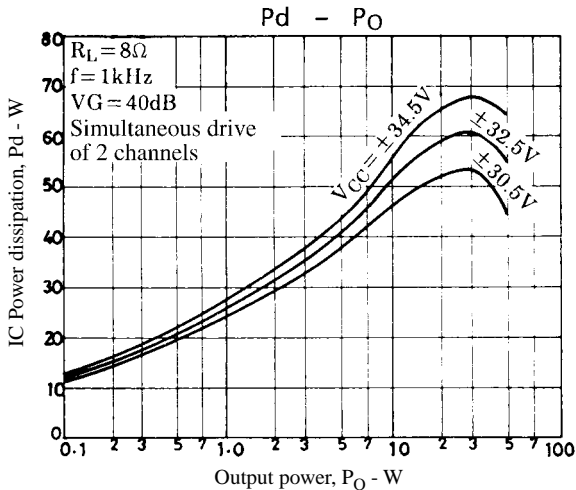

Figure 1. STK4171V Pd - P<sub>O</sub> (R<sub>L</sub> = 8Ω)

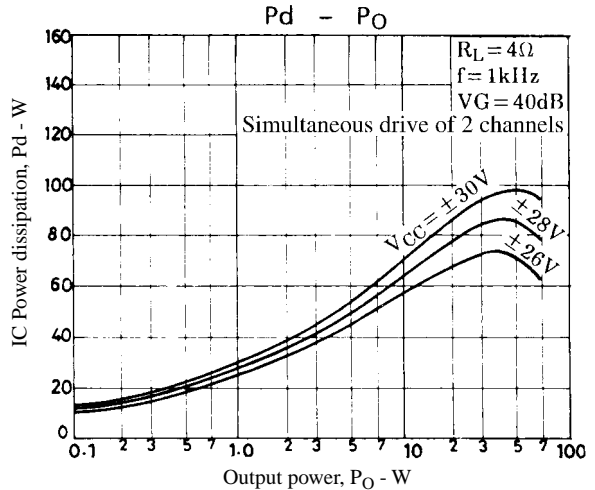

Figure 2. STK4171V Pd - P<sub>O</sub> (R<sub>L</sub> = 4Ω)

In an actual application where a music signal is used, it is impractical to estimate the power dissipation based on the continuous signal as shown above, because too large a heat sink must be used. It is reasonable to estimate the power dissipation as 1/10 Po max. (EIAJ).

That is, Pd = 38W at 8Ω, Pd = 49W at 4Ω

Thermal resistance θc-a of a heat sink for this IC power dissipation (Pd) is fixed under conditions 1 and 2 shown below.

Condition 1:  $T_c = P_d \times \theta_{c-a} + T_a \leq 125^\circ\text{C}$ ..... (1)

where Ta : Specified ambient temperature  
Tc : Operating substrate temperature

Condition 2:  $T_j = P_d \times (\theta_{c-a}) + P_d/4 \times (\theta_{j-c}) + T_a \leq 150^\circ\text{C}$ ..... (2)

where Tj : Junction temperature of power transistor

Assuming that the power dissipation is shared equally among the four power transistors (2 channels × 2), thermal resistance θj-c is 1.8°C/W and

$P_d \times (\theta_{c-a} + 1.8/4) + T_a \leq 150^\circ\text{C}$ ..... (3)

Thermal resistance θc-a of a heat sink must satisfy inequalities (1) and (3).

Figure 3 shows the relation between Pd and θc-a given from (1) and (3) with Ta as a parameter.

[Example] The thermal resistance of a heat sink is obtained when the ambient temperature specified for a stereo amplifier is 50°C.

Assuming VCC = ±32.5V, RL = 8Ω,

VCC = ±28V, RL = 4Ω,

RL = 8Ω : Pd1 = 38W at 1/10 Po max.

RL = 4Ω : Pd2 = 49W at 1/10 Po max.

The thermal resistance of a heat sink is obtained from Figure 3.

RL = 8Ω : θc-a1 = 1.97°C/W

RL = 4Ω : θc-a2 = 1.53°C/W

Tj when a heat sink is used is obtained from (3).

RL = 8Ω : Tj = 141.9°C

RL = 4Ω : Tj = 147°C

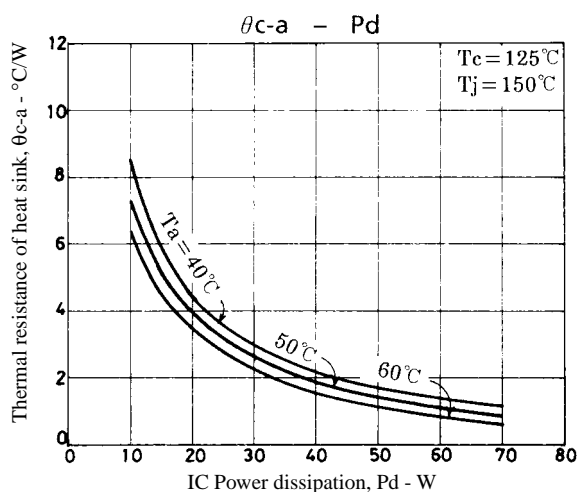

Figure 3. STK4171V θc-a – Pd

- No products described or contained herein are intended for use in surgical implants, life-support systems, aerospace equipment, nuclear power control systems, vehicles, disaster/crime-prevention equipment and the like, the failure of which may directly or indirectly cause injury, death or property loss.
- Anyone purchasing any products described or contained herein for an above-mentioned use shall:
  - ① Accept full responsibility and indemnify and defend SANYO ELECTRIC CO., LTD., its affiliates, subsidiaries and distributors and all their officers and employees, jointly and severally, against any and all claims and litigation and all damages, cost and expenses associated with such use:
  - ② Not impose any responsibility for any fault or negligence which may be cited in any such claim or litigation on SANYO ELECTRIC CO., LTD., its affiliates, subsidiaries and distributors or any of their officers and employees, jointly or severally.
- Information (including circuit diagrams and circuit parameters) herein is for example only; it is not guaranteed for volume production. SANYO believes information herein is accurate and reliable, but no guarantees are made or implied regarding its use or any infringements of intellectual property rights or other rights of third parties.