

## Features

- Dual Mode Low Drop Out Voltage Regulator
- 2.8V Fixed Output Voltage
- 3V to 5.5V Supply Operation
- 160 mA Maximum Load Current in Full Power Mode
- Maximum Current Consumption 61  $\mu$ A in Full Power Mode and 12  $\mu$ A in Low Power Mode
- Power-down Mode Consumption Less Than 1  $\mu$ A
- More Than 70dB (Typical) PSRR at 1 KHz
- 70  $\mu$ V<sub>RMS</sub> Output Noise
- 0.35  $\mu$ m CMOS Technology
- Typical Application: Baseband Memory Section Supply in Mobile Terminals

## Description

RE024 is a dual mode Low Drop Out (LDO) voltage regulator macrocell with a fixed 2.8V output voltage, rated for loads up to 160 mA in full power mode and 5 mA in low power mode. (Both modes can be selected by the LP2 signal.) It is designed to be integrated with other analog cells, digital logic, microcontrollers, DSP cores and memory blocks into system-on-chip products.

The circuit consists of a PMOS pass device, an error amplifier and a feedback resistive network, sized to achieve the required closed loop gain. These blocks make up the regulating loop. An over-current and short circuit protection circuit has been included to limit the output current delivered by the regulator, thus avoiding destruction in case of a short circuit.

An external reference voltage  $V_{BG}$  (bandgap voltage) is necessary for correct functionality. The target reference voltage is 1.231V delivered, for example, by BG019. Double pads on the supply voltage  $V_{BAT2C}/V_{BAT2CC}$  and output voltage  $V_{MEMA}/V_{MEMAA}$  are used to reduce the total output resistance. Current reference is generated inside the cell through a circuit supplied by a  $2.5V \pm 0.1V$  of regulated input voltage on  $V_{SAUVC}$ . Remote sense terminal  $V_{MEMS}$  provides regulation of the load by connecting it to the output terminal near a critical point to improve performance of the regulator (e.g., connecting it to the package pin by double-bonding, thus avoiding the bonding resistance influence). A ceramic capacitor of 2.2  $\mu$ F connected from  $V_{MEMA}/V_{MEMAA}$  to ground is needed as external compensation.

A low-leakage current switch has been added to charge a second external capacitor (2.2  $\mu$ F - 10  $\mu$ F) to  $V_{MEMA}/V_{MEMAA}$ . This voltage, called  $V_{BACKUP}$  is used to guarantee 30 minutes of operation time for the internal system clock and calendar in backup mode when the main battery is unplugged.

Figure 1. Symbol <sup>(1)</sup>

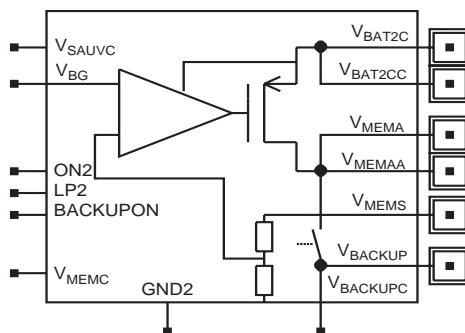

Note: 1. Pin names are written as they appear on the user screen when the symbol is opened in the design tool environment.



Embedded ASIC  
Macrocell:  
Power  
Management for  
Mobile  
Terminals (PM)

RE024 2.8V  
160 mA  
Dual Mode LDO  
Regulator



## Functional Diagram

Figure 2. Functional Diagram

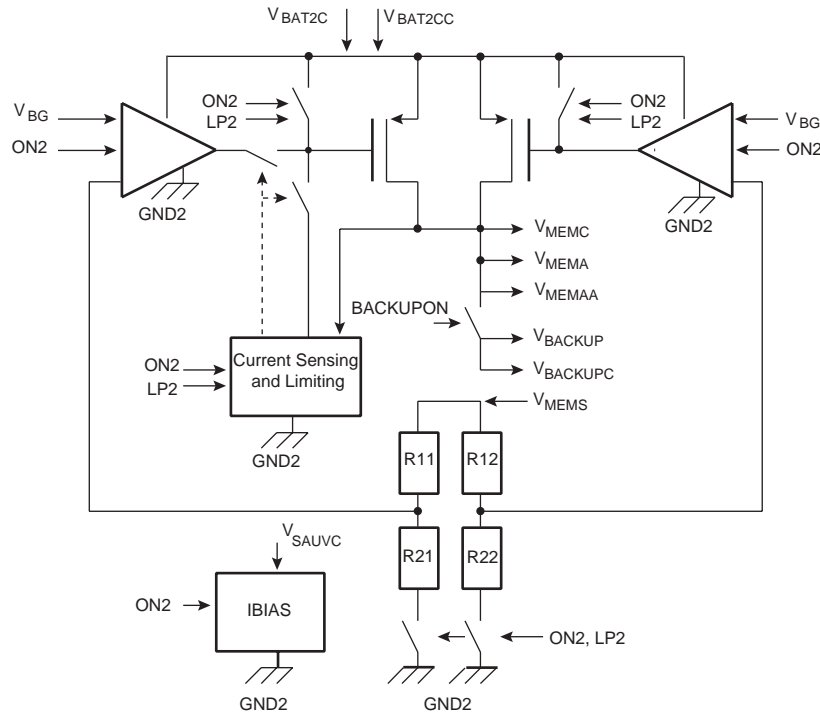

## Pin Description

Pin Name	I/O	Type	Function	Value
$V_{BAT2C}$	Power Supply	External Pad	Power Supply	3V to 5.5V
$V_{BAT2CC}$	Power Supply	External Pad	Power Supply	3V to 5.5V
$V_{MEMA}$	Analog Output	External Pad	Output Voltage	2.75V to 2.9
$V_{MEMAA}$	Analog Output	External Pad	Output Voltage	2.75V to 2.9V
$V_{MEMS}$	Analog Input	External Pad	Sense Voltage	2.75V to 2.9V
$V_{MEMC}$	Analog Output	Internal Pin	Output Voltage	2.75V to 2.9V
$V_{BACKUP}$	Analog Input	External Pad	Backup Voltage	2.75V to 2.9V
$V_{BACKUPC}$	Analog Output	Internal Pin	Internal Backup Voltage	2.75V to 2.9V
GND2	Analog Ground	Internal Pin	Ground	0
$V_{SAUVC}$	Positive Power Supply	Internal Pin	Power Supply	$2.5V \pm 0.1V$
$V_{BG}$	Analog Input	Internal Pin	Voltage Reference	1.231V
ON2	Digital Input	Internal Pin	Enable Command	0V or $V_{BAT2C}/V_{BAT2CC}$
LP2	Digital Input	Internal Pin	Low Power Mode Command	0V or $V_{BAT2C}/V_{BAT2CC}$
BACKUPON	Digital Input	Internal Pin	Backup Mode Command	0V or $V_{BAT2C}/V_{BAT2CC}$

# RE024 2.8V 160 mA Dual Mode LDO Regulator

## Absolute Maximum Ratings\*

Analog Signals .....	-0.3V to 6.5V
Digital Signals.....	-0.3V to 5.5V
Output Current.....	Internally limited
Junction Temperature .....	-20°C to 150°C

\*NOTICE: Stresses beyond those listed under “Absolute Maximum Ratings” may cause permanent damage to the device. This is a stress rating only and functional operation of the device at these or other conditions beyond those indicated in the operational sections of this specification is not implied. Exposure to absolute maximum rating conditions for extended periods may affect device reliability.

## Electrical Specifications<sup>(1)</sup>

$T_J = -20^\circ\text{C}$  to  $125^\circ\text{C}$ ,  $V_{BAT2C}/V_{BAT3CC} = 3\text{V}$  to  $5.5\text{V}$  unless otherwise specified, output capacitance =  $2.2\ \mu\text{F}$ .

**Table 1.** Electrical Characteristics

Symbol	Parameter	Condition	Min	Typ	Max	Unit	
$V_{BAT2C}/V_{BAT2CC}$	Operating Supply Voltage		3		5.5	V	
$V_{SAUVC}$	Auxiliary Operating Supply Voltage		2.4	2.5	2.6	V	
$T_J$	Temperature Range		-20		125	°C	
<b>Full Power Mode</b>							
$V_{MEMA}/V_{MEMAA}$	Output Voltage		2.75		2.85	V	
$I_{MEMA}/I_{MEMAA}$	Output Current				160	mA	
$I_{QQ}$	Quiescent Current		43	51	61	μA	
$\Delta V_{DC}$	Line Regulation	$I_{MEMA}/I_{MEMAA} = 160\ \text{mA}$		4	7	mV	
$\Delta V_{TRAN}$	Transient Line Regulation	$I_{MEMA}/I_{MEMAA} = 160\ \text{mA}$ rise time = fall time = $5\ \mu\text{s}$		18	33	mV	
$\Delta V_{DC}$	Load Regulation	10% - 90% of max $I_{MEMA}/I_{MEMAA}$		3	10	mV	
$\Delta V_{TRAN}$	Transient Load Regulation	10% - 90% of max $I_{MEMA}/I_{MEMAA}$ rise time = fall time = $5\ \mu\text{s}$		25	66	mV	
PSRR <sup>(2)</sup>	Power Supply Rejection Ratio at Full Load	$V_{BAT2C}/V_{BAT2CC} = 3\text{V}$	@ 100 Hz		-30		dB
			@ 1 kHz		-30		dB
			@ 20 kHz		-27		dB
			@ 100 kHz		-20		dB
		$V_{BAT2C}/V_{BAT2CC} = 4.25\text{V}$	@ 100 Hz		-70		dB
			@ 1 kHz		-70		dB
			@ 20 kHz		-47		dB
			@ 100 kHz		-32		dB
		$V_{BAT2C}/V_{BAT2CC} = 5.5\text{V}$	@ 100 Hz		-70		dB
			@ 1 kHz		-65		dB
			@ 20 kHz		-47		dB
			@ 100 kHz		-30		dB
$V_N$	Output Noise <sup>(3)</sup>	Bandwidth = 10 Hz to 100 kHz		70	118	μV <sub>RMS</sub>	



**Table 1. Electrical Characteristics (Continued)**

Symbol	Parameter	Condition	Min	Typ	Max	Unit	
$T_R$	Rise Time	Full Load 10% - 90% of $V_{MEMA}/V_{MEMAA}$			200	$\mu s$	
$I_{SD}$	Shut Down Current				1	$\mu A$	
$I_{CC}$	Short-circuit Current Threshold				450	mA	
<b>Low Power Mode</b>							
$V_{MEMA}/V_{MEMAA}$	Output Voltage		2.72		2.9	V	
$I_{MEMA}/I_{MEMAA}$	Output Current				5	mA	
$I_{QQ}$	Quiescent Current		9	10.5	12	$\mu A$	
$\Delta V_{DC}$	Line Regulation	$V_{BAT2C}/V_{BAT2CC} = 3.4V$ to $3.0V$ $I_{MEMA}/I_{MEMAA} = 2$ mA		2	3	mV	
$\Delta V_{TRAN}$	Transient Line Regulation	$V_{BAT2C}/V_{BAT2CC} = 3.4V$ to $3.0V$ $I_{MEMA}/I_{MEMAA} = 2$ mA rise time = fall time = $5 \mu s$		2	4	mV	
$\Delta V_{DC}$	Load Regulation	10% - 90% of max $I_{MEMA}/I_{MEMAA}$		2	5	mV	
$\Delta V_{TRAN}$	Transient Load Regulation	10% - 90% of max $I_{MEMA}/I_{MEMAA}$ rise time = fall time = $5 \mu s$		2	6	mV	
PSRR <sup>(2)</sup>	Power Supply Rejection Ratio at Full Load	$V_{BAT2C}/V_{BAT2CC} = 3V$	@ 100 Hz		-40		dB
			@ 1 kHz		-40		dB
			@ 20 kHz		-35		dB
			@ 100 kHz		-35		dB
		$V_{BAT2C}/V_{BAT2CC} = 4.25V$	@ 100 Hz		-70		dB
			@ 1 kHz		-65		dB
			@ 20 kHz		-47		dB
			@ 100 kHz		-30		dB
		$V_{BAT2C}/V_{BAT2CC} = 5.5V$	@ 100 Hz		-55		dB
			@ 1 kHz		-55		dB
			@ 20 kHz		-46		dB
			@ 100 kHz		-35		dB
$V_N$	Output Noise <sup>(3)</sup>	Bandwidth = 10 Hz to 100 kHz		204	300	$\mu V_{RMS}$	
$T_R$	Rise Time	Full Load 10% - 90% of $V_{MEMA}/V_{MEMAA}$			500	$\mu s$	
$I_{SD}$	Shut Down Current				1	$\mu A$	
$I_{CC}$	Short-circuit Current Threshold				240	mA	

- Notes: 1. Obtained by considering the parasitics of a TFBGA100 Package.  
2. This parameter shows the immunization of the circuit taking into account a voltage ripple on battery voltage for different frequencies shown.  
3. Obtained by using BG019 as reference voltage generator.

# RE024 2.8V 160 mA Dual Mode LDO Regulator

## Control Modes

All digital signals are referred to the supply voltage  $V_{BAT}$ .

**Table 2.** Truth Table

ON2	LP2	$V_{MEMA}/V_{MEMAA}$
0	X	Power down (High-Z)
1	0	Power on, Full Power Mode $V_{MEMA}/V_{MEMAA} = 2.8V$
1	1	Power on, Low Power Mode $V_{MEMA}/V_{MEMAA} = 2.8V$

**Table 3.** Backupon Truth Table

BACKUPON	$V_{BACKUP}$
0	Backup Mode
1	Backup Switch Closed $V_{BACKUP} = V_{MEMA}/V_{MEMAA}$

## Application Example

A ceramic capacitor of 2.2  $\mu F$  with ESR between 20 m $\Omega$  and 250 m $\Omega$  connected from  $V_{MEMA}/V_{MEMAA}$  to ground is needed for external compensation.

A ceramic capacitor with a value between 2.2  $\mu F$  and 10 $\mu F$  connected between  $V_{BACKUP}$  and Ground is used as backup supply.

Description	Min	Typ	Max	Units
Capacitor ( $C_L$ )	1.8	2.2	2.6	$\mu F$
Backup Battery ( $C_{BCK}$ )	2.2		10	$\mu F$

**Figure 3.** Application Example

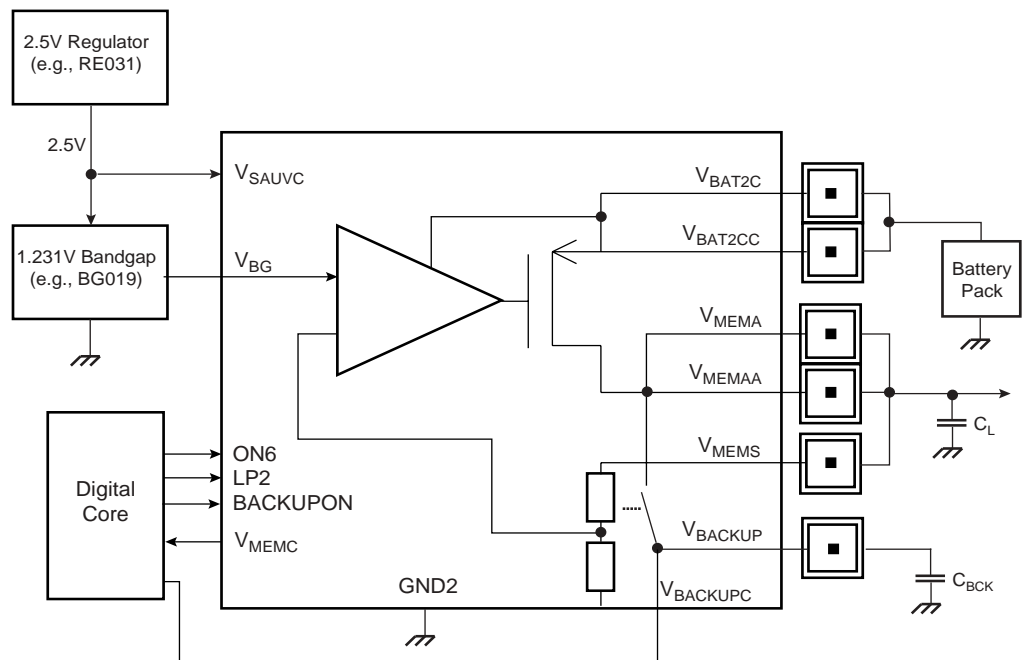

# Typical Performance Characteristics (Conditions specified on page 10)

Note.

In these graphs:

- Output Voltage refers to  $V_{MEMA}/V_{MEMAA}$
- Battery Voltage refers to  $V_{BAT2C}/V_{BAT2CC}$
- Output Current refers to  $I_{MEMA}/I_{MEMAA}$

Static Line Regulation at Full Load in Full Power Mode

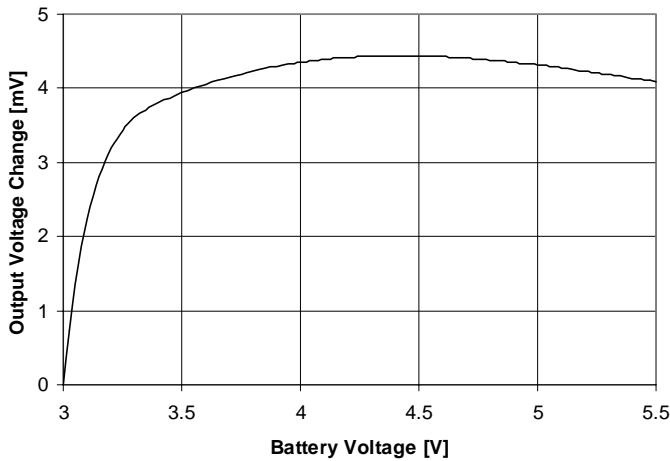

Static Load Regulation in Full Power Mode

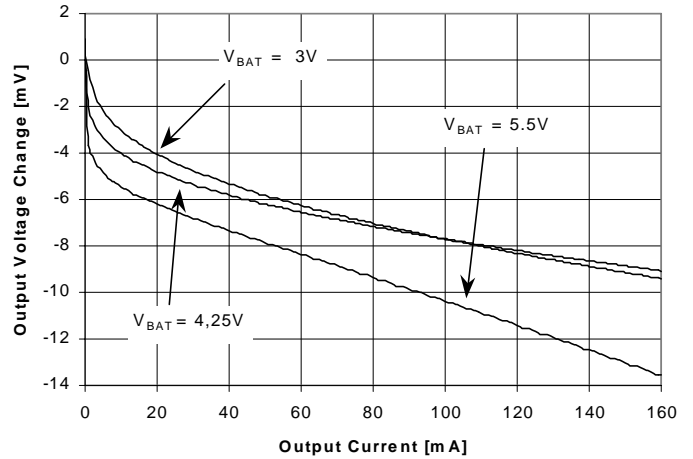

Transient Line Regulation at Full Load in Full Power Mode

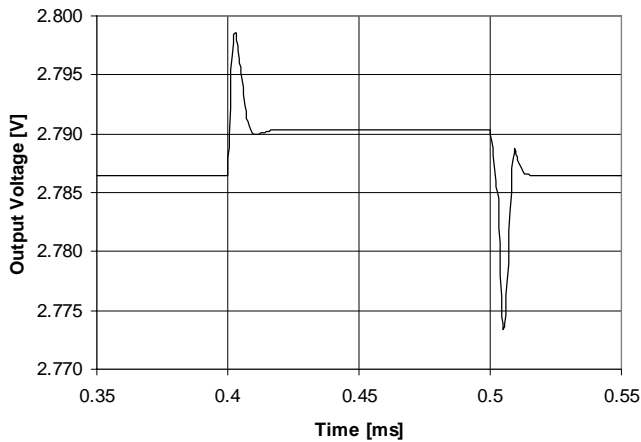

Transient Load Regulation in Full Power Mode

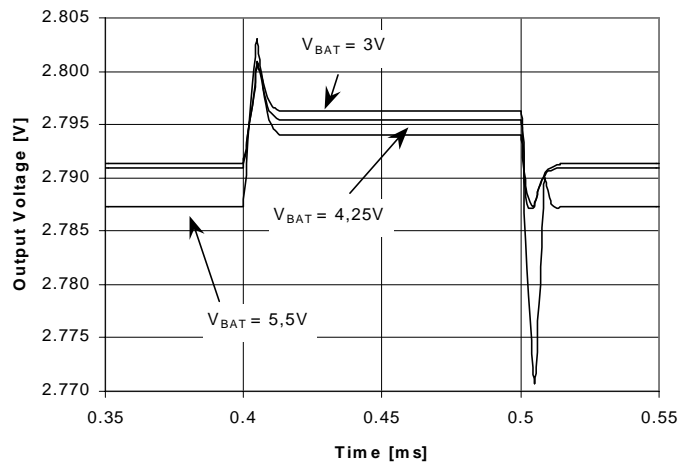

# RE024 2.8V 160 mA Dual Mode LDO Regulator

## Typical Performance Characteristics (Conditions specified on page 10)

Power Supply Rejection Ratio at Full Load  
in Full Power Mode

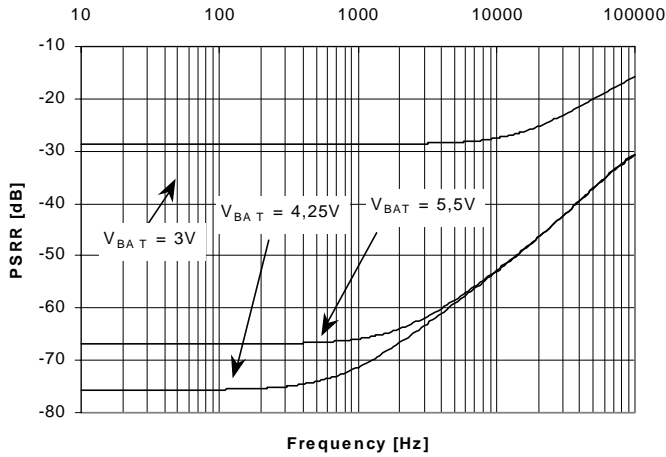

Power Supply Rejection Ratio at Full Load  
Versus Battery Voltage in Full Power Mode

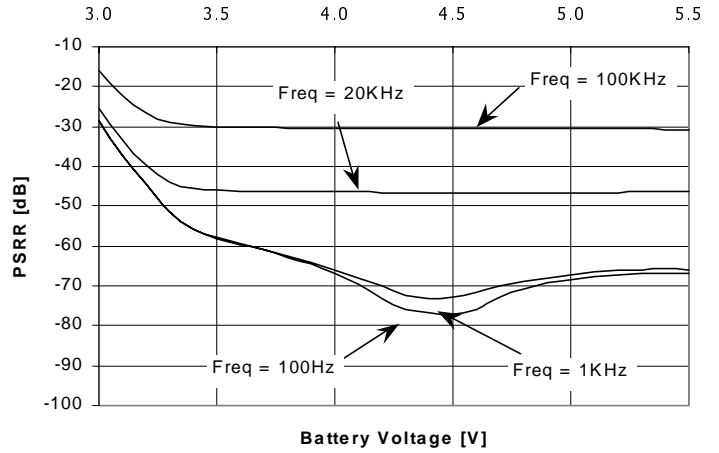

Startup at Full Load for  $V_{BAT} = 4.25V$   
in Full Power Mode

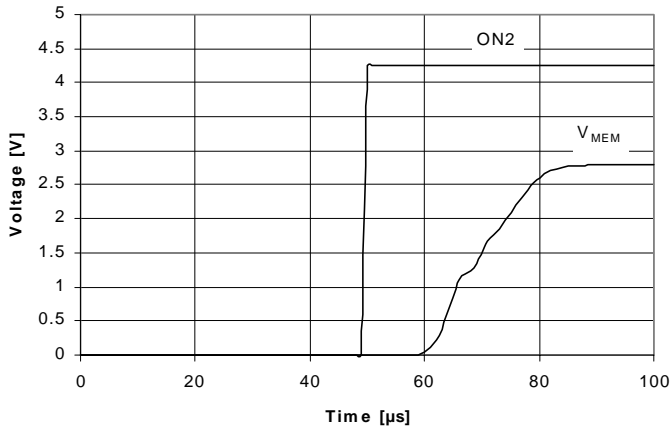

Output Noise Spectrum at Full Load and  $V_{BAT} = 4.25V$   
in Full Power Mode

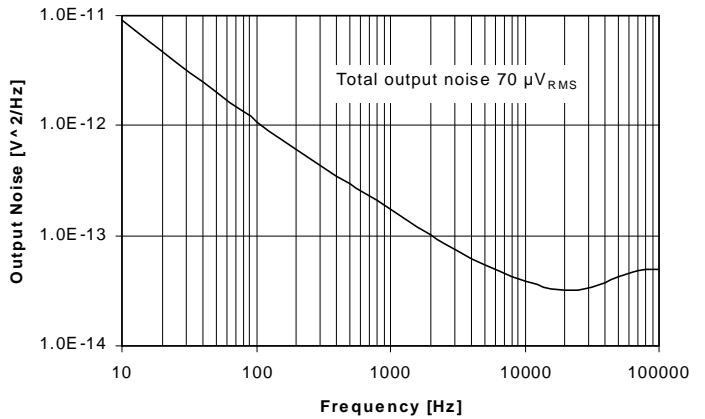

# Typical Performance Characteristics (Conditions specified on page 10)

Static Line Regulation at Full Load in Low Power Mode

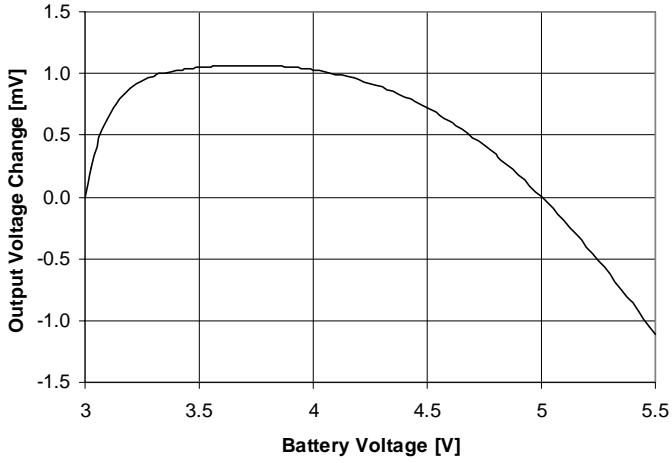

Static Load Regulation in Low Power Mode

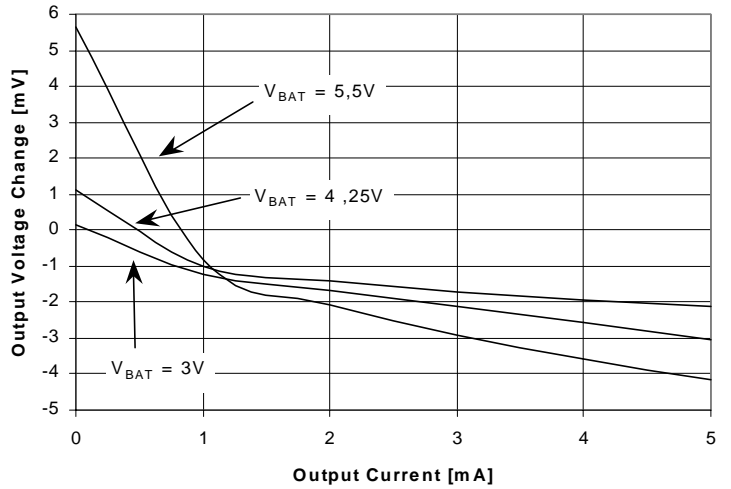

Transient Line Regulation at Full Load in Low Power Mode

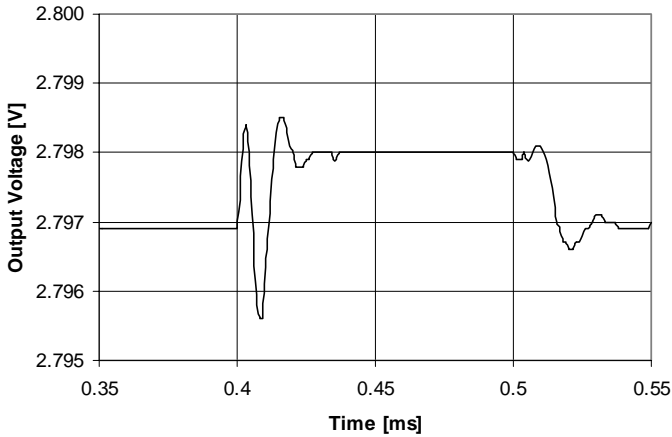

Transient Load Regulation in Low Power Mode

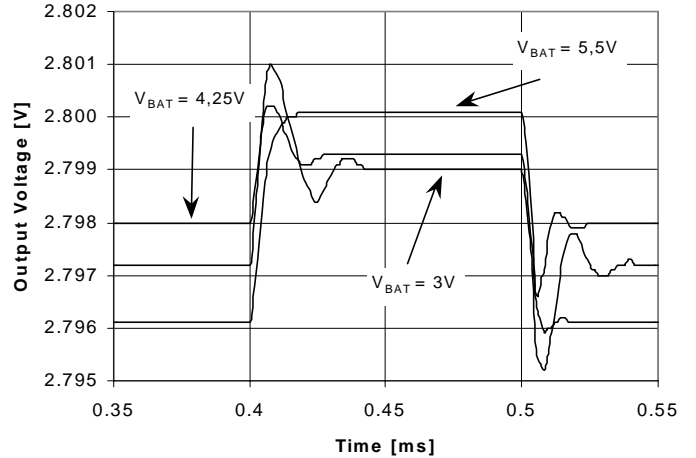



# RE024 2.8V 160 mA Dual Mode LDO Regulator

## Typical Performance Characteristics (Conditions specified on page 10)

Power Supply Rejection Ratio at Full Load  
in Low Power Mode

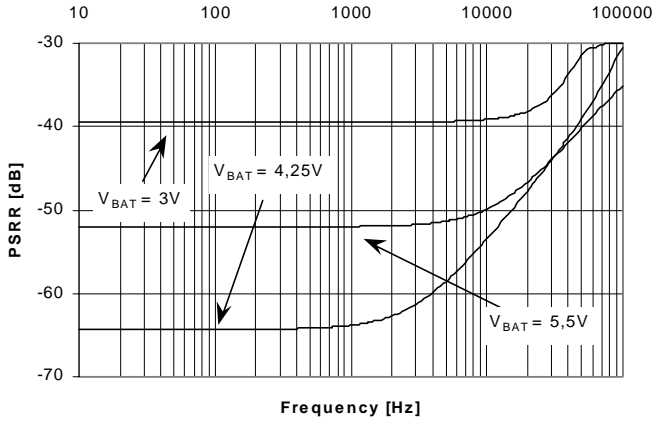

Power Supply Rejection Ratio at Full Load Versus  
Battery Voltage in Low Power Mode

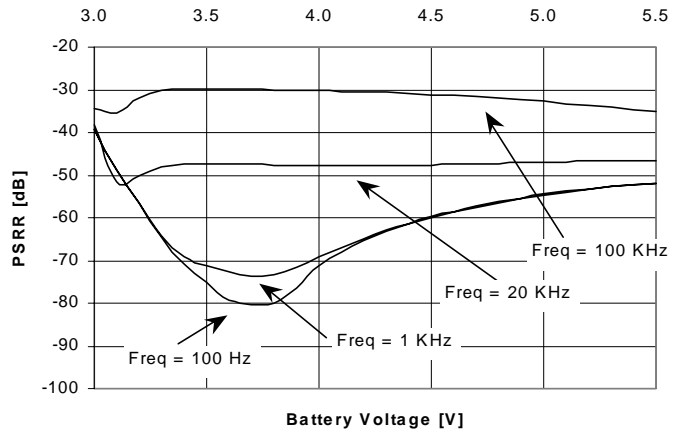

Startup at Full Load for  $V_{BAT} = 4.25V$   
in Low Power Mode

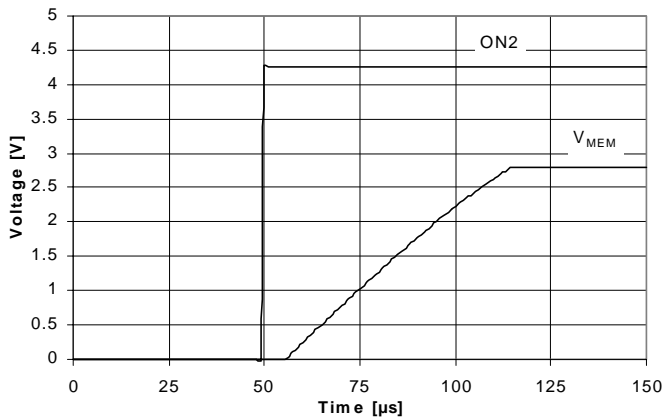

Output Noise Spectrum at Full Load and  $V_{BAT} = 4.25V$   
in Low Power Mode

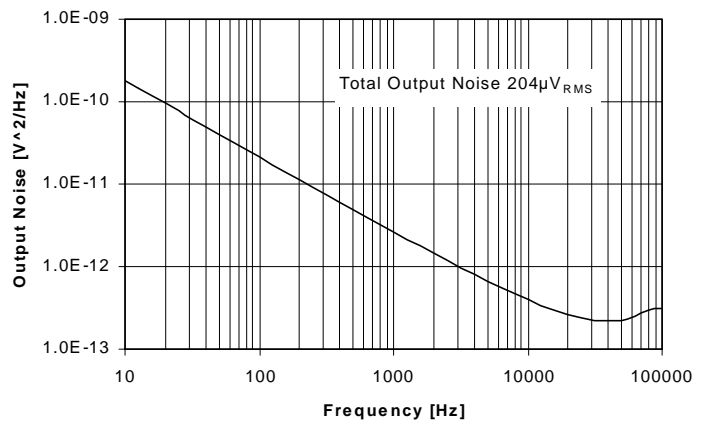

## Terminology

### Line Regulation

Measures the maximum transient and DC variations of the output voltage of the RE024 when the supply changes between two specified values with fixed load current; minimum rise time and fall time is 5  $\mu$ s.

**Figure 4.** Line Regulation

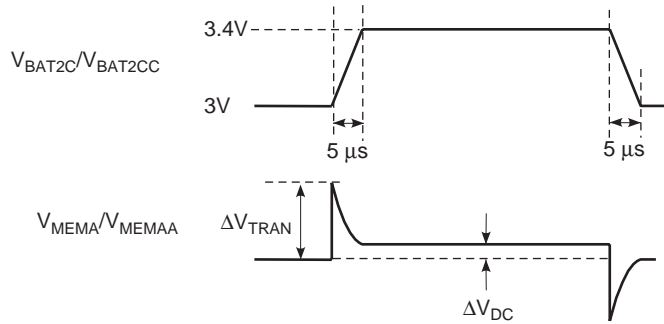

### Load Regulation

Measures the maximum transient and DC variations of the output voltage of the RE024 when the load current changes between two specified values with fixed power supply; minimum rise time and fall time is 5  $\mu$ s.

**Figure 5.** Load Regulation

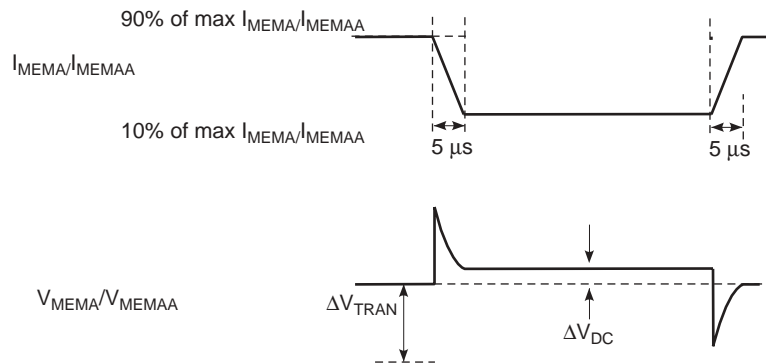



## Atmel Headquarters

### **Corporate Headquarters**

2325 Orchard Parkway  
San Jose, CA 95131  
TEL 1(408) 441-0311  
FAX 1(408) 487-2600

### **Europe**

Atmel Sarl  
Route des Arsenaux 41  
Case Postale 80  
CH-1705 Fribourg  
Switzerland  
TEL (41) 26-426-5555  
FAX (41) 26-426-5500

### **Asia**

Room 1219  
Chinachem Golden Plaza  
77 Mody Road Tsimhatsui  
East Kowloon  
Hong Kong  
TEL (852) 2721-9778  
FAX (852) 2722-1369

### **Japan**

9F, Tonetsu Shinkawa Bldg.  
1-24-8 Shinkawa  
Chuo-ku, Tokyo 104-0033  
Japan  
TEL (81) 3-3523-3551  
FAX (81) 3-3523-7581

## Atmel Operations

### **Memory**

2325 Orchard Parkway  
San Jose, CA 95131  
TEL 1(408) 441-0311  
FAX 1(408) 436-4314

### **Microcontrollers**

2325 Orchard Parkway  
San Jose, CA 95131  
TEL 1(408) 441-0311  
FAX 1(408) 436-4314

La Chantrerie  
BP 70602  
44306 Nantes Cedex 3, France  
TEL (33) 2-40-18-18-18  
FAX (33) 2-40-18-19-60

### **ASIC/ASSP/Smart Cards**

Zone Industrielle  
13106 Rousset Cedex, France  
TEL (33) 4-42-53-60-00  
FAX (33) 4-42-53-60-01

1150 East Cheyenne Mtn. Blvd.  
Colorado Springs, CO 80906  
TEL 1(719) 576-3300  
FAX 1(719) 540-1759

Scottish Enterprise Technology Park  
Maxwell Building  
East Kilbride G75 0QR, Scotland  
TEL (44) 1355-803-000  
FAX (44) 1355-242-743

### **RF/Automotive**

Theresienstrasse 2  
Postfach 3535  
74025 Heilbronn, Germany  
TEL (49) 71-31-67-0  
FAX (49) 71-31-67-2340

1150 East Cheyenne Mtn. Blvd.  
Colorado Springs, CO 80906  
TEL 1(719) 576-3300  
FAX 1(719) 540-1759

### **Biometrics/Imaging/Hi-Rel MPU/ High Speed Converters/RF Datacom**

Avenue de Rochepleine  
BP 123  
38521 Saint-Egreve Cedex, France  
TEL (33) 4-76-58-30-00  
FAX (33) 4-76-58-34-80

---

### **e-mail**

literature@atmel.com

### **Web Site**

<http://www.atmel.com>

### **© Atmel Corporation 2003.**

Atmel Corporation makes no warranty for the use of its products, other than those expressly contained in the Company's standard warranty which is detailed in Atmel's Terms and Conditions located on the Company's web site. The Company assumes no responsibility for any errors which may appear in this document, reserves the right to change devices or specifications detailed herein at any time without notice, and does not make any commitment to update the information contained herein. No licenses to patents or other intellectual property of Atmel are granted by the Company in connection with the sale of Atmel products, expressly or by implication. Atmel's products are not authorized for use as critical components in life support devices or systems.

ATMEL® is the registered trademark of Atmel.

Other terms and product names may be the trademarks of others.



Printed on recycled paper.

2703B-PMGMT-02/03 OM