

Features

- Single Device: +5V Input
- Complimentary Dual Output: $\pm 12V$, $\pm 15V$
- Wide Input Voltage Range
- 85% Efficiency
- Adjustable Output Voltage
- Laser-trimmed

Description

The PT5060 series of dual-output Integrated Switching Regulators (ISRs) provide a complimentary $\pm 12V$ or $\pm 15V$ from a single +5V input. Applications include systems that require power for analog interface circuitry, such as D/A and A/D converters, and Op Amps. The output voltage can be adjusted with an external resistor. These ISRs are made available in a 12-pin single in-line pin (SIP) package. Note that these modules are not short-circuit protected.

Standard Application

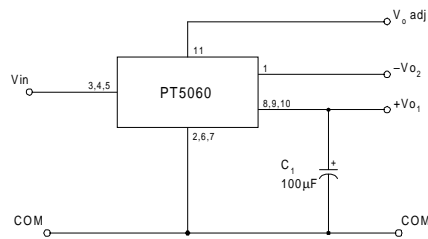

C_1 = Required 100µF electrolytic

Pin-Out Information

Pin	Function
1	$-V_{O2}$
2	GND
3	V_{in}
4	V_{in}
5	V_{in}
6	GND
7	GND
8	$+V_{O1}$
9	$+V_{O1}$
10	$+V_{O1}$
11	V_o Adj
12	Do Not Connect

Ordering Information

PT5061□ = ± 12 Volts

PT5062□ = ± 15 Volts

PT Series Suffix (PT1234 x)

Case/Pin Configuration	Order Suffix	Package Code *
Vertical	N	(ECD)
Horizontal	A	(ECA)
SMD	C	(ECC)
Vertical, Side Tabs	R	(ECE)
Horizontal, Side Tabs	G	(ECG)
SMD, Side Tabs	B	(ECK)

* Previously known as package style 300.

(Reference the applicable package code drawing for the dimensions and PC board layout)

Specifications (Unless otherwise stated, $T_a = 25^\circ C$, $V_{in} = +5V$, $I_o = I_{o,max}$, $C_1 = 100\mu F$)

Characteristics	Symbol	Conditions	PT5060 SERIES			Units	
			Min	Typ	Max		
Output Current	I_o	Over V_{in} range	$V_{O1} = +12V$ $V_{O2} = -12V$	0.05 0.05 (1)	— —	0.50 0.25	A
Current Limit	I_{lim}			—	150 (2)	—	% $I_{o,max}$
Inrush Current	I_{ir}	On start up		—	5.5 (3)	—	A
	t_{tr}			—	2	—	mSec
Input Voltage Range	V_{in}	Over I_o range		4.75	—	$+V_o - 1$	V
Output Voltage Tolerance	ΔV_o	Over V_{in} and I_o ranges $T_a = 0^\circ C$ to SOA limit (3)	$+V_{O1}$ $-V_{O2}$	— —	± 1.5 ± 5	± 3.0 ± 10	% V_o
Line Regulation	Reg_{line}	Over V_{in} range		—	± 0.5	± 1.0	% V_o
Load Regulation	Reg_{load}	$0.1 \leq I_o \leq I_{o,max}$		—	± 0.5	± 1.0	% V_o
V_o Ripple (pk-pk)	V_n	20MHz bandwidth	$+V_{O1}$ $-V_{O2}$	— —	± 1.5 ± 2	± 3 ± 3	% V_o
Transient Response	t_{tr} V_{os}	25% load change V_o over/undershoot		— —	100 3	— 5	μ Sec % V_o
Efficiency	η	$I_o = 0.2A$ each output		—	85	—	%
Switching Frequency	f_s	Over V_{in} and I_o ranges		—	650	—	kHz
Operating Temperature Range	T_a	—		0	—	$+85$ (4)	$^\circ C$
Storage Temperature	T_s	—		-40	—	$+125$	$^\circ C$
Mechanical Shock		Per Mil-STD-883D, Method 2002.3, 1 msec, Half Sine, mounted to a fixture	—	500	—	G's	
Mechanical Vibration		Per Mil-STD-883D, Method 2007.2 20-2000 Hz, Soldered in a PC board	—	15	—	G's	
Weight				—	6.5	—	grams

- Notes:**
- (1) Do not operate the negative output rail of these ISRs below the minimum load.
 - (2) ISRs based on a boost topology are not short-circuit protected.
 - (3) The inrush current stated is above the normal input current for the associated output load.
 - (4) See Safe Operating Area curves or consult the factory for the appropriate derating.

PT5061 +/- 12VDC (See Note A)

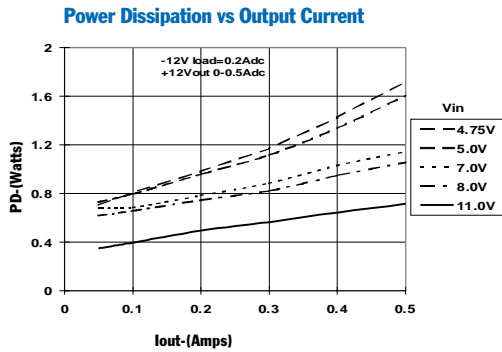
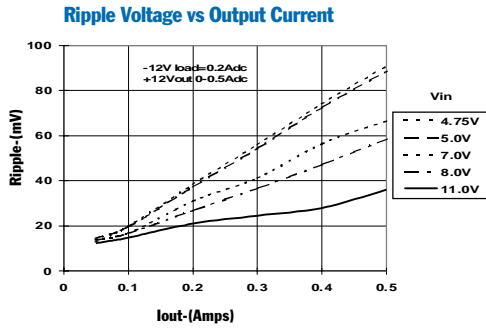
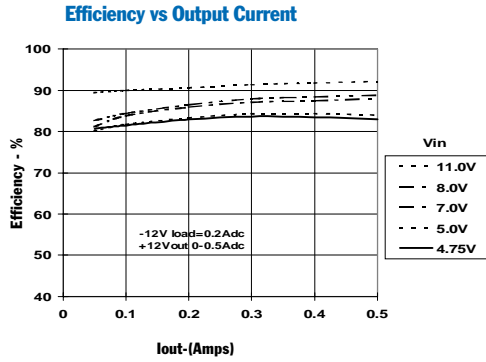

Safe Operating Area, $V_{in} = 5.0V$; $I_{o2} = 0.25A$ (See Note B)

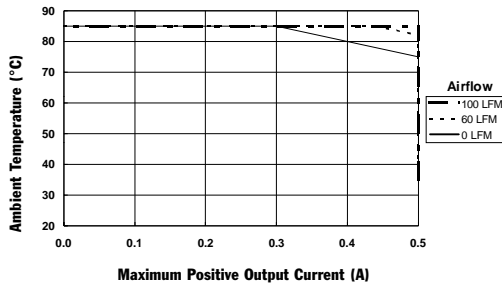

PT5062 +/- 15V (See Note A)

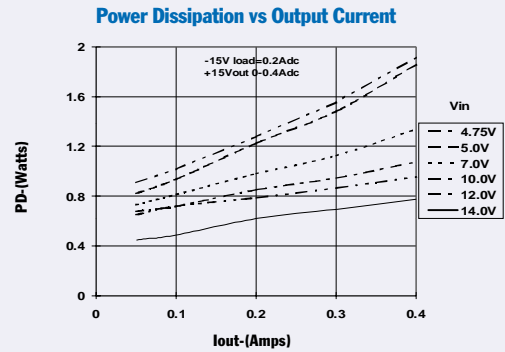
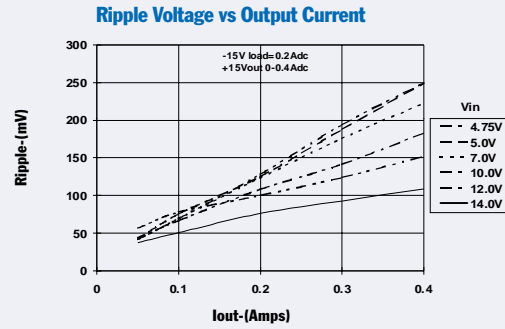
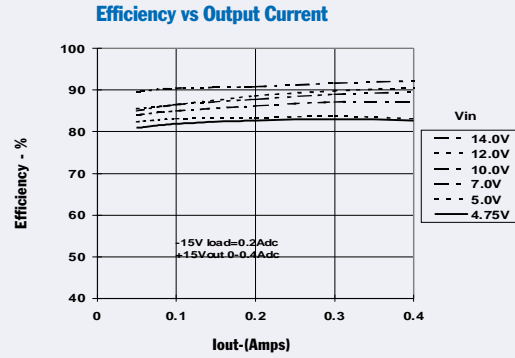

Safe Operating Area $V_{in} = 5.0V$, $I_{o2} = 0.2A$ (See Note B)

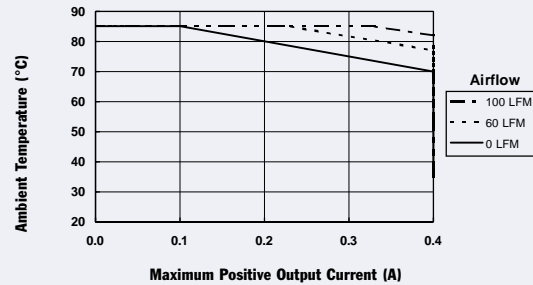

Note A: Characteristic data has been developed from actual products tested at 25°C. This data is considered typical data for the Converter.
Note B: Thermal derating graphs are developed in free-air convection cooling, which corresponds to approximately 40-60 LFM of airflow.

Adjusting the Output Voltage of the PT5060 Dual-Output Boost Converter Series

The dual output voltage of the PT5060 series modules can be adjusted higher or lower than the factory pre-set voltage with the addition of a single external resistor. Table 1 gives the applicable adjustment range for each model in the series as V_a (min) and V_a (max).

Adjust Up: An increase in the output voltage is obtained by adding a resistor R_2 , between pin 11 (V_o adj) and pins 2, 6, or 7 (GND).

Adjust Down: Add a resistor (R_1), between pin 11 (V_o adj) and pins 8, 9 or 10 (V_{o1}).

Refer to Figure 1 and Table 2 for both the placement and value of the required resistor, either (R_1) or R_2 as appropriate.

Notes:

- Both the positive and negative voltage outputs from the ISR are adjusted simultaneously.
- Use only a single 1% resistor in either the (R_1) or R_2 location. Place the resistor as close to the ISR as possible.
- Never connect capacitors from V_o adj to either GND or V_{o1} . Any capacitance added to the V_o adjust pin will affect the stability of the ISR.
- An increase in the output voltage must be accompanied by a corresponding reduction in the specified maximum current at each output. For V_{o1} and $-V_{o2}$, the revised maximum output current must be reduced to the equivalent of 6 watts and 3 watts respectively. i.e.

$$I_{o1}(\text{max}) = \frac{6}{V_a} \text{ A dc}$$

and

$$I_{o2}(\text{max}) = \frac{3}{V_a} \text{ A dc,}$$

where V_a is the adjusted output voltage.

- Adjustments to the output voltage will also limit the maximum input voltage that can be applied to the ISR. The maximum input voltage that may be applied is limited to $(V_o - 1)\text{Vdc}$ or 14Vdc, whichever is less.

Figure 1

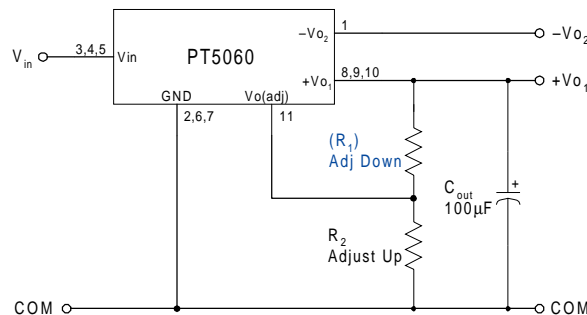

The values of (R_1) [adjust down], and R_2 [adjust up], can also be calculated using the following formulas.

$$(R_1) = \frac{3.65 (V_a - 2.5)}{(V_o - V_a)} - 0.1 \quad \text{k}\Omega$$

$$R_2 = \frac{9.125}{V_a - V_o} - 0.1 \quad \text{k}\Omega$$

Where: V_o = Original output voltage
 V_a = Adjusted output voltage

Table 1
PT5060 ADJUSTMENT AND FORMULA PARAMETERS

Series Pt #	PT5061	PT5062
V_o (nom)	±12.0V	±15.0V
V_a (min)	± 7.5V	± 7.5V
V_a (max)	±14.0V	±20.0V

Table 2
PT5060 ADJUSTMENT RESISTOR VALUES

Series Pt #	PT5061	PT5062
Current	0.5/0.25A dc	0.4/0.2A dc
V_o (nom)	±12.0Vdc	±15.0Vdc
V_a (req'd)		
7.0		
7.5	(4.0)kΩ	(2.3)kΩ
8.0	(4.9)kΩ	(2.8)kΩ
8.5	(6.2)kΩ	(3.3)kΩ
9.0	(7.8)kΩ	(3.9)kΩ
9.5	(10.1)kΩ	(4.6)kΩ
10.0	(13.6)kΩ	(5.4)kΩ
10.5	(19.4)kΩ	(6.4)kΩ
11.0	(30.9)kΩ	(7.7)kΩ
11.5	(65.6)kΩ	(9.3)kΩ
12.0		(11.5)kΩ
12.5	18.2kΩ	(14.5)kΩ
13.0	9.0kΩ	(19.1)kΩ
13.5	6.0kΩ	(26.7)kΩ
14.0	4.5kΩ	(41.9)kΩ
14.5		(87.5)kΩ
15.0		
15.5		18.2kΩ
16.0		9.0kΩ
16.5		6.0kΩ
17.0		4.5kΩ
17.5		3.6kΩ
18.0		2.9kΩ
18.5		2.5kΩ
19.0		2.2kΩ
19.5		1.9kΩ
20.0		1.7kΩ

R_1 = (Blue) R_2 = Black

PACKAGING INFORMATION

Orderable Device	Status (1)	Package Type	Package Drawing	Pins	Package Qty	Eco Plan (2)	Lead/Ball Finish	MSL Peak Temp (3)	Samples (Requires Login)
PT5061A	LIFEBUY	SIP MODULE	ECA	12	12	Pb-Free (RoHS)	Call TI	N / A for Pkg Type	
PT5061C	LIFEBUY	SIP MODULE	ECC	12	12	Pb-Free (RoHS)	Call TI	Level-1-215C-UNLIM	
PT5061N	LIFEBUY	SIP MODULE	ECD	12	12	Pb-Free (RoHS)	Call TI	N / A for Pkg Type	
PT5061R	LIFEBUY	SIP MODULE	ECE	12	12	Pb-Free (RoHS)	Call TI	N / A for Pkg Type	
PT5062A	LIFEBUY	SIP MODULE	ECA	12	12	Pb-Free (RoHS)	Call TI	N / A for Pkg Type	
PT5062C	LIFEBUY	SIP MODULE	ECC	12	12	Pb-Free (RoHS)	Call TI	Level-1-215C-UNLIM	
PT5062G	LIFEBUY	SIP MODULE	ECG	12	12	Pb-Free (RoHS)	Call TI	N / A for Pkg Type	
PT5062N	LIFEBUY	SIP MODULE	ECD	12	12	Pb-Free (RoHS)	Call TI	N / A for Pkg Type	

(1) The marketing status values are defined as follows:

ACTIVE: Product device recommended for new designs.

LIFEBUY: TI has announced that the device will be discontinued, and a lifetime-buy period is in effect.

NRND: Not recommended for new designs. Device is in production to support existing customers, but TI does not recommend using this part in a new design.

PREVIEW: Device has been announced but is not in production. Samples may or may not be available.

OBSELETE: TI has discontinued the production of the device.

(2) Eco Plan - The planned eco-friendly classification: Pb-Free (RoHS), Pb-Free (RoHS Exempt), or Green (RoHS & no Sb/Br) - please check <http://www.ti.com/productcontent> for the latest availability information and additional product content details.

TBD: The Pb-Free/Green conversion plan has not been defined.

Pb-Free (RoHS): TI's terms "Lead-Free" or "Pb-Free" mean semiconductor products that are compatible with the current RoHS requirements for all 6 substances, including the requirement that lead not exceed 0.1% by weight in homogeneous materials. Where designed to be soldered at high temperatures, TI Pb-Free products are suitable for use in specified lead-free processes.

Pb-Free (RoHS Exempt): This component has a RoHS exemption for either 1) lead-based flip-chip solder bumps used between the die and package, or 2) lead-based die adhesive used between the die and leadframe. The component is otherwise considered Pb-Free (RoHS compatible) as defined above.

Green (RoHS & no Sb/Br): TI defines "Green" to mean Pb-Free (RoHS compatible), and free of Bromine (Br) and Antimony (Sb) based flame retardants (Br or Sb do not exceed 0.1% by weight in homogeneous material)

(3) MSL, Peak Temp. -- The Moisture Sensitivity Level rating according to the JEDEC industry standard classifications, and peak solder temperature.

Important Information and Disclaimer: The information provided on this page represents TI's knowledge and belief as of the date that it is provided. TI bases its knowledge and belief on information provided by third parties, and makes no representation or warranty as to the accuracy of such information. Efforts are underway to better integrate information from third parties. TI has taken and continues to take reasonable steps to provide representative and accurate information but may not have conducted destructive testing or chemical analysis on incoming materials and chemicals. TI and TI suppliers consider certain information to be proprietary, and thus CAS numbers and other limited information may not be available for release.

In no event shall TI's liability arising out of such information exceed the total purchase price of the TI part(s) at issue in this document sold by TI to Customer on an annual basis.

IMPORTANT NOTICE

Texas Instruments Incorporated and its subsidiaries (TI) reserve the right to make corrections, enhancements, improvements and other changes to its semiconductor products and services per JESD46, latest issue, and to discontinue any product or service per JESD48, latest issue. Buyers should obtain the latest relevant information before placing orders and should verify that such information is current and complete. All semiconductor products (also referred to herein as "components") are sold subject to TI's terms and conditions of sale supplied at the time of order acknowledgment.

TI warrants performance of its components to the specifications applicable at the time of sale, in accordance with the warranty in TI's terms and conditions of sale of semiconductor products. Testing and other quality control techniques are used to the extent TI deems necessary to support this warranty. Except where mandated by applicable law, testing of all parameters of each component is not necessarily performed.

TI assumes no liability for applications assistance or the design of Buyers' products. Buyers are responsible for their products and applications using TI components. To minimize the risks associated with Buyers' products and applications, Buyers should provide adequate design and operating safeguards.

TI does not warrant or represent that any license, either express or implied, is granted under any patent right, copyright, mask work right, or other intellectual property right relating to any combination, machine, or process in which TI components or services are used. Information published by TI regarding third-party products or services does not constitute a license to use such products or services or a warranty or endorsement thereof. Use of such information may require a license from a third party under the patents or other intellectual property of the third party, or a license from TI under the patents or other intellectual property of TI.

Reproduction of significant portions of TI information in TI data books or data sheets is permissible only if reproduction is without alteration and is accompanied by all associated warranties, conditions, limitations, and notices. TI is not responsible or liable for such altered documentation. Information of third parties may be subject to additional restrictions.

Resale of TI components or services with statements different from or beyond the parameters stated by TI for that component or service voids all express and any implied warranties for the associated TI component or service and is an unfair and deceptive business practice. TI is not responsible or liable for any such statements.

Buyer acknowledges and agrees that it is solely responsible for compliance with all legal, regulatory and safety-related requirements concerning its products, and any use of TI components in its applications, notwithstanding any applications-related information or support that may be provided by TI. Buyer represents and agrees that it has all the necessary expertise to create and implement safeguards which anticipate dangerous consequences of failures, monitor failures and their consequences, lessen the likelihood of failures that might cause harm and take appropriate remedial actions. Buyer will fully indemnify TI and its representatives against any damages arising out of the use of any TI components in safety-critical applications.

In some cases, TI components may be promoted specifically to facilitate safety-related applications. With such components, TI's goal is to help enable customers to design and create their own end-product solutions that meet applicable functional safety standards and requirements. Nonetheless, such components are subject to these terms.

No TI components are authorized for use in FDA Class III (or similar life-critical medical equipment) unless authorized officers of the parties have executed a special agreement specifically governing such use.

Only those TI components which TI has specifically designated as military grade or "enhanced plastic" are designed and intended for use in military/aerospace applications or environments. Buyer acknowledges and agrees that any military or aerospace use of TI components which have **not** been so designated is solely at the Buyer's risk, and that Buyer is solely responsible for compliance with all legal and regulatory requirements in connection with such use.

TI has specifically designated certain components as meeting ISO/TS16949 requirements, mainly for automotive use. In any case of use of non-designated products, TI will not be responsible for any failure to meet ISO/TS16949.

Products

Audio	www.ti.com/audio
Amplifiers	amplifier.ti.com
Data Converters	dataconverter.ti.com
DLP® Products	www.dlp.com
DSP	dsp.ti.com
Clocks and Timers	www.ti.com/clocks
Interface	interface.ti.com
Logic	logic.ti.com
Power Mgmt	power.ti.com
Microcontrollers	microcontroller.ti.com
RFID	www.ti-rfid.com
OMAP Applications Processors	www.ti.com/omap
Wireless Connectivity	www.ti.com/wirelessconnectivity

Applications

Automotive and Transportation	www.ti.com/automotive
Communications and Telecom	www.ti.com/communications
Computers and Peripherals	www.ti.com/computers
Consumer Electronics	www.ti.com/consumer-apps
Energy and Lighting	www.ti.com/energy
Industrial	www.ti.com/industrial
Medical	www.ti.com/medical
Security	www.ti.com/security
Space, Avionics and Defense	www.ti.com/space-avionics-defense
Video and Imaging	www.ti.com/video

TI E2E Community

e2e.ti.com