

For Immediate Assistance, Contact Your Local Salesperson



OPT202



PHOTODIODE WITH ON-CHIP AMPLIFIER

FEATURES

- BANDWIDTH: 50kHz
- PHOTODIODE SIZE: 0.090 x 0.090 inch (2.29 x 2.29mm)
- 1MΩ FEEDBACK RESISTOR
- HIGH RESPONSIVITY: 0.45A/W (650nm)
- LOW DARK ERRORS: 2mV
- WIDE SUPPLY RANGE: ±2.25 to ±18V
- LOW QUIESCENT CURRENT: 400μA
- TRANSPARENT 8-PIN DIP AND 5-PIN SIP
- HERMETIC 8-PIN CERAMIC DIP

APPLICATIONS

- MEDICAL INSTRUMENTATION
- LABORATORY INSTRUMENTATION
- POSITION AND PROXIMITY SENSORS
- PHOTOGRAPHIC ANALYZERS
- SMOKE DETECTORS

DESCRIPTION

The OPT202 is an opto-electronic integrated circuit containing a photodiode and transimpedance amplifier on a single dielectrically isolated chip. The transimpedance amplifier consists of a precision FET-input op amp and an on-chip metal film resistor. The 0.09 x 0.09 inch photodiode is operated at zero bias for excellent linearity and low dark current.

The integrated combination of photodiode and transimpedance amplifier on a single chip eliminates the problems commonly encountered in discrete designs such as leakage current errors, noise pick-up and gain peaking due to stray capacitance.

The OPT202 operates over a wide supply range (±2.25 to ±18V) and supply current is only 400μA. It is packaged in a transparent plastic 8-pin DIP or 5-pin SIP, specified for the 0°C to +70°C temperature range as well as a hermetic ceramic 8-pin DIP with a glass window, specified for the -40°C to +85°C temperature range.

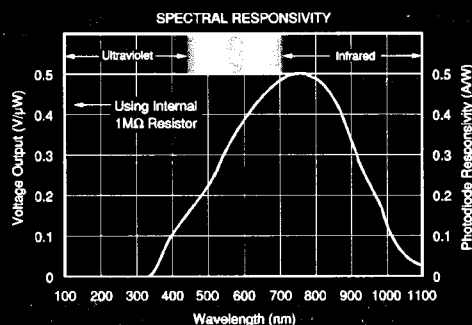
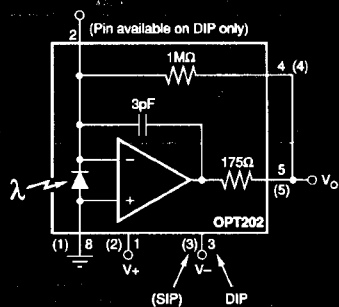

International Airport Industrial Park • Mailing Address: PO Box 11400 • Tucson, AZ 85734 • Street Address: 6730 S. Tucson Blvd. • Tucson, AZ 85706
Tel: (602) 746-1111 • Twx: 910-952-1111 • Cable: BBRCORP • Telex: 985-6481 • FAX: (602) 889-1510 • Immediate Product Info: (602) 548-6132



Or, Call Customer Service at 1-800-540-6132 (USA Only)

SPECIFICATIONS

ELECTRICAL

$T_s = +25^\circ\text{C}$, $V_s = \pm 15\text{V}$, $\lambda = 650\text{nm}$, internal $1\text{M}\Omega$ feedback resistor, unless otherwise noted.

PARAMETER	CONDITIONS	OPT202P, W, G			UNITS
		MIN	TYP	MAX	
RESPONSIVITY					
Photodiode Current	650nm		0.45		A/W
Voltage Output	650nm		0.45		V/ μW
vs Temperature			100		ppm/ $^\circ\text{C}$
Unit-to-Unit Variation	650nm		± 5		%
Nonlinearity ⁽¹⁾	FS Output = 10V (0.090 x 0.090in) (2.29 x 2.29mm)		0.01		% of FS
Photodiode Area			0.008		in ²
			5.2		mm ²
DARK ERRORS, RTO⁽²⁾					
Offset Voltage, Output: P, W Packages			± 0.5	± 2	mV
G Package			± 0.5	± 3	mV
vs Temperature			± 10		$\mu\text{V}/^\circ\text{C}$
vs Power Supply	$V_s = \pm 2.25\text{V}$ to $\pm 18\text{V}$		10	100	$\mu\text{V}/\text{V}$
Voltage Noise	Measured BW = 0.1Hz to 100kHz		1		mVrms
RESISTOR—1MΩ Internal					
Resistance			1		M Ω
Tolerance: P, G Packages			± 0.5	± 2	%
W Package			± 0.5		%
vs Temperature			50		ppm/ $^\circ\text{C}$
FREQUENCY RESPONSE					
Bandwidth, Large or Small-Signal, -3dB			50		kHz
Rise Time, 10% to 90%			10		μs
Settling Time, 1%	FS to Dark		10		μs
0.1%	FS to Dark		20		μs
0.01%	FS to Dark		40		μs
Overload Recovery Time (to 1%)	100% Overdrive, $V_s = \pm 15\text{V}$		44		μs
	100% Overdrive, $V_s = \pm 5\text{V}$		100		μs
	100% Overdrive, $V_s = \pm 2.25\text{V}$		240		μs
OUTPUT					
Voltage Output	$R_L = 10\text{k}\Omega$	$(V_s) - 1.25$	$(V_s) - 1$		V
Capacitive Load; Stable Operation	$R_L = 5\text{k}\Omega$	$(V_s) - 2$	$(V_s) - 1.5$		V
Short-Circuit Current			10		nF
			± 18		mA
POWER SUPPLY					
Specified Operating Voltage			± 15		V
Operating Voltage Range		± 2.25		± 18	V
Quiescent Current	$V_o = 0$		± 400	± 500	μA
TEMPERATURE RANGE					
Specification: P, W Packages			-	+70	$^\circ\text{C}$
G Package			-40	+85	$^\circ\text{C}$
Operating: P, W Packages			0	+70	$^\circ\text{C}$
G Package			-55	+125	$^\circ\text{C}$
Storage: P, W Packages			-25	+85	$^\circ\text{C}$
G Package			-55	+125	$^\circ\text{C}$
Thermal Resistance, θ_{JA}			100		$^\circ\text{C}/\text{W}$

NOTES: (1) Deviation in percent of full scale from best-fit straight line. (2) Referred to Output. Includes all error sources.

OPT202

G

OPTICAL SENSORS



For Immediate Assistance, Contact Your Local Salesperson

SPECIFICATIONS (CONT)

ELECTRICAL

Op Amp Section of OPT202⁽¹⁾

$T_A = +25^\circ\text{C}$, $V_S = \pm 15\text{V}$, unless otherwise noted.

PARAMETER	CONDITIONS	OPT202 Op Amp			UNITS
		MIN	TYP	MAX	
INPUT Offset Voltage vs Temperature vs Power Supply Input Bias Current vs Temperature	$V_S = \pm 2.25\text{V to } \pm 18\text{V}$		± 0.5 ± 5 10 1 doubles every 10°C		mV $\mu\text{V}/^\circ\text{C}$ $\mu\text{V/V}$ μA
NOISE Input Voltage Noise Voltage Noise Density, $f = 10\text{Hz}$ $f = 100\text{Hz}$ $f = 1\text{kHz}$ Current Noise Density, $f = 1\text{kHz}$			30 25 15 0.8		$\text{nV}/\sqrt{\text{Hz}}$ $\text{nV}/\sqrt{\text{Hz}}$ $\text{nV}/\sqrt{\text{Hz}}$ $\text{fA}/\sqrt{\text{Hz}}$
INPUT VOLTAGE RANGE Common-mode Input Range Common-mode Rejection			± 14.4 106		V dB
INPUT IMPEDANCE Differential Common-mode			$10^9 3$ $10^9 3$		ΩpF ΩpF
OPEN-LOOP GAIN Open-loop Voltage Gain			120		dB
FREQUENCY RESPONSE Gain-Bandwidth Product Slew Rate Settling Time 0.1% 0.01%			16 6 4 5		MHz V/ μs μs μs
OUTPUT Voltage Output Short-Circuit Current	$R_L = 10\text{k}\Omega$ $R_L = 5\text{k}\Omega$	$(V_+) - 1.25$ $(V_+) - 2$	$(V_+) - 1$ $(V_+) - 1.5$ ± 18		V V mA
POWER SUPPLY Specified Operating Voltage Operating Voltage Range Quiescent Current	$I_O = 0$	± 2.25	± 15 ± 400	± 18 ± 500	V V μA

NOTE: (1) Op amp specifications provided for information and comparison only.

PHOTODIODE SPECIFICATIONS

$T_A = +25^\circ\text{C}$, unless otherwise noted.

PARAMETER	CONDITIONS	Photodiode of OPT202			UNITS
		MIN	TYP	MAX	
Photodiode Area	$(0.090 \times 0.090\text{in})$ $(2.29 \times 2.29\text{mm})$		0.008		in^2
Current Responsivity	650nm		5.2		mm^2
Dark Current vs Temperature	$V_O = 0\text{V}^{(1)}$		0.45 500 doubles every 10°C		A/W fA
Capacitance	$V_O = 0\text{V}^{(1)}$		600		pF

NOTE: (1) Voltage Across Photodiode.

The information provided herein is believed to be reliable; however, BURR-BROWN assumes no responsibility for inaccuracies or omissions. BURR-BROWN assumes no responsibility for the use of this information, and all use of such information shall be entirely at the user's own risk. Prices and specifications are subject to change without notice. No patent rights or licenses to any of the circuits described herein are implied or granted to any third party. BURR-BROWN does not authorize or warrant any BURR-BROWN product for use in life support devices and/or systems.

Or, Call Customer Service at 1-800-548-6132 (USA Only)

DICE INFORMATION

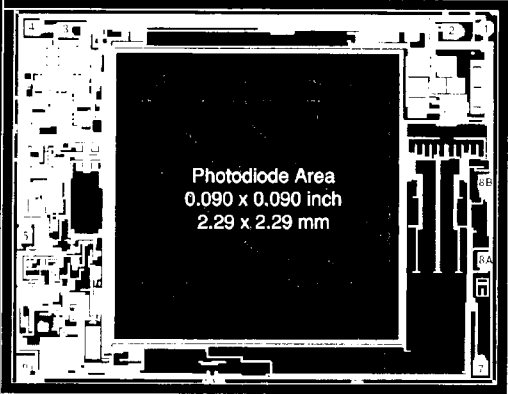

Photodiode Area
0.090 x 0.090 inch
2.29 x 2.29 mm

OPT202 DIE TOPOGRAPHY

PAD	FUNCTION
1	V ₊
2	-In
3	V ₋
4	1MΩ Feedback
5	Output
6	NC
7	NC
8A, 8B	Common

NC: No Connection. Pads 8A and 8B must both be connected to common. Substrate Bias: The substrate is electrically connected to internal circuitry. Do not make electrical connection to the substrate.

MECHANICAL INFORMATION

	MILS (0.001")	MILLIMETERS
Die Size	154 x 120 ±5	3.91 x 3.05 ±0.13
Die Thickness	20 ±3	0.51 ±0.08
Min. Pad Size	4 x 4	0.1 x 0.1
Backing		None

PIN CONFIGURATIONS

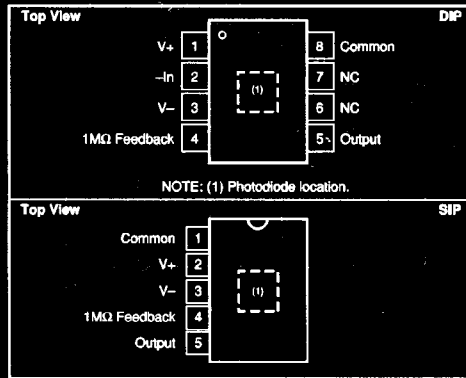

ABSOLUTE MAXIMUM RATINGS

Supply Voltage	±16V
Input Voltage Range (Common Pin)	±V _s
Output Short-Circuit (to ground)	Continuous
Operating Temperature: P, W	-25°C to +85°C
G	-55°C to +125°C
Storage Temperature: P, W	-25°C to +85°C
G	-55°C to +125°C
Junction Temperature: P, W	+85°C
G	+150°C
Lead Temperature (soldering, 10s)	+300°C
(Vapor-Phase Soldering Not Recommended on Plastic Packages)	

PACKAGE INFORMATION⁽¹⁾

MODEL	PACKAGE	PACKAGE DRAWING NUMBER
OPT202P	8-Pin Plastic DIP	006-1
OPT202W	5-Pin Plastic SIP	321
OPT202G	8-Pin Ceramic DIP	161-1

NOTE: (1) For detailed drawing and dimension table, please see end of data sheet, or Appendix D of Burr-Brown IC Data Book.



ELECTROSTATIC DISCHARGE SENSITIVITY

This integrated circuit can be damaged by ESD. Burr-Brown recommends that all integrated circuits be handled with appropriate precautions. Failure to observe proper handling and installation procedures can cause damage.

ESD damage can range from subtle performance degradation to complete device failure. Precision integrated circuits may be more susceptible to damage because very small parametric changes could cause the device not to meet its published specifications.



MOISTURE SENSITIVITY AND SOLDERING

Clear plastic does not contain the structural-enhancing fillers used in black plastic molding compound. As a result, clear plastic is more sensitive to environmental stress than black plastic. This can cause difficulties if devices have been stored in high humidity prior to soldering. The rapid heating during soldering can stress wire bonds and cause failures. Prior to soldering, it is recommended that plastic devices be baked-out at 85°C for 24 hours.

The fire-retardant fillers used in black plastic are not compatible with clear molding compound. The OPT202 plastic packages cannot meet flammability test, UL-94.

OPT202
6
OPTICAL SENSORS



For Immediate Assistance, Contact Your Local Salesperson

TYPICAL PERFORMANCE CURVES

At $T_a = +25^\circ\text{C}$, $V_s = \pm 15\text{V}$, $\lambda = 650\text{nm}$, unless otherwise noted.

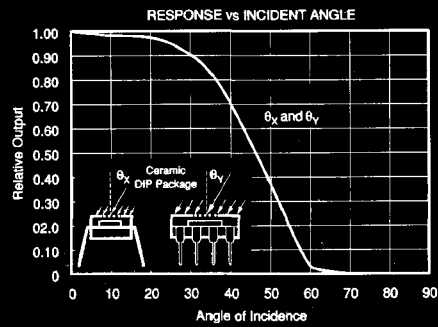
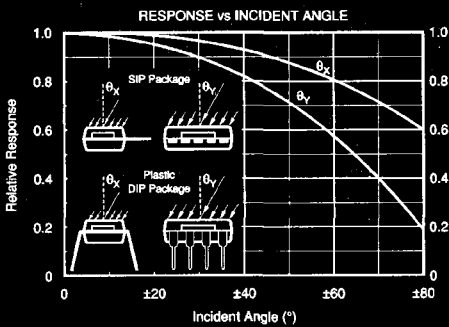
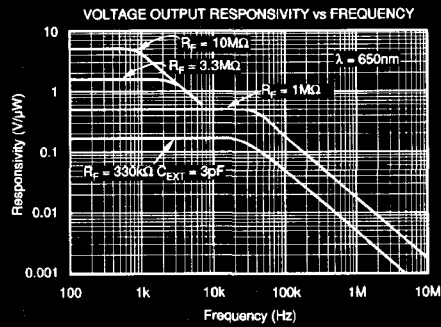
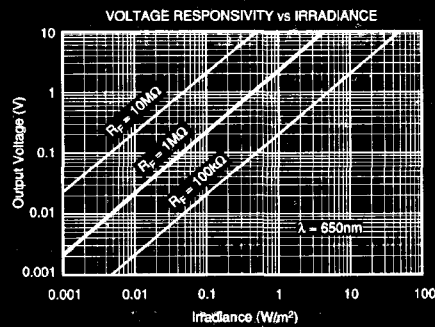
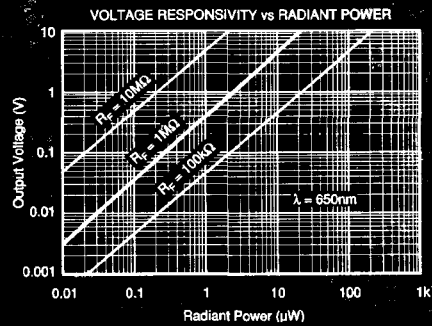
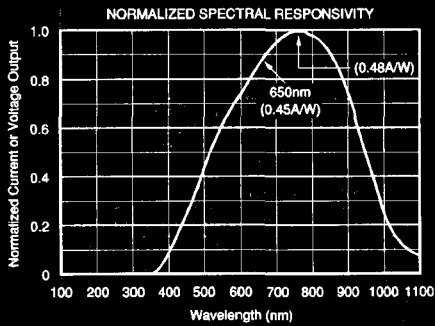

Or, Call Customer Service at 1-800-548-6132 (USA Only)

TYPICAL PERFORMANCE CURVES

At $T_a = +25^\circ\text{C}$, $V_s = \pm 15\text{V}$, $\lambda = 650\text{nm}$, unless otherwise noted.

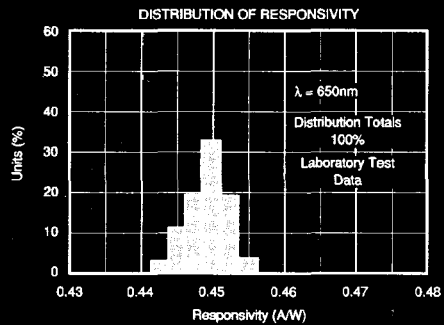
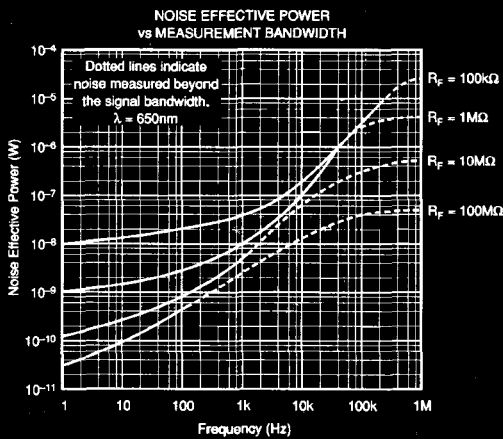
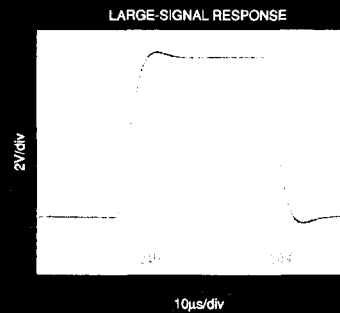
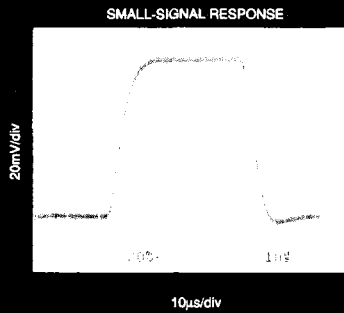
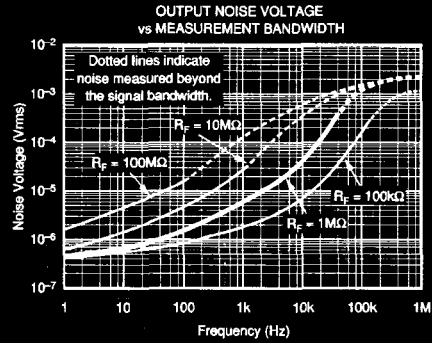
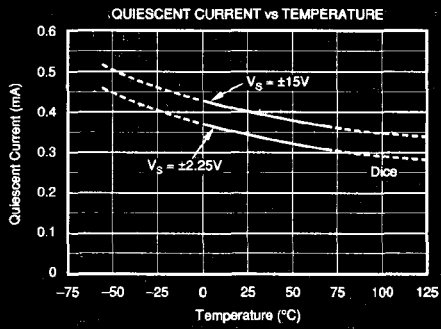

For Immediate Assistance, Contact Your Local Salesperson

APPLICATIONS INFORMATION

Figure 1 shows the basic connections required to operate the OPT202. Applications with high-impedance power supplies may require decoupling capacitors located close to the device pins as shown. Output is zero volts with no light and increases with increasing illumination.

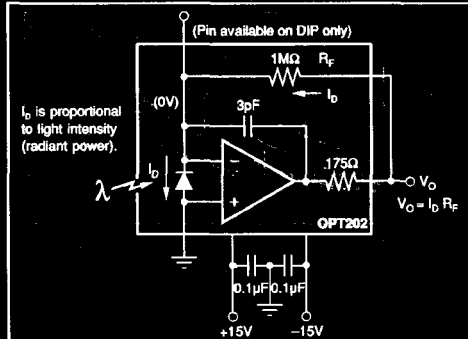

FIGURE 1. Basic Circuit Connections.

Photodiode current, I_b , is proportional to the radiant power or flux (in watts) falling on the photodiode. At a wavelength of 650nm (visible red) the photodiode Responsivity, R_p , is approximately 0.45A/W. Responsivity at other wavelengths is shown in the typical performance curve "Responsivity vs Wavelength."

The typical performance curve "Output Voltage vs Radiant Power" shows the response throughout a wide range of radiant power. The response curve "Output Voltage vs Irradiance" is based on the photodiode area of $5.23 \times 10^{-4} \text{m}^2$.

The OPT202's voltage output is the product of the photodiode current times the feedback resistor, ($I_b R_F$). The internal feedback resistor is laser trimmed to $1\text{M}\Omega \pm 2\%$. Using this resistor, the output voltage responsivity, R_v , is approximately $0.45\text{V}/\mu\text{W}$ at 650nm wavelength.

An external resistor can be connected to set a different voltage responsivity. Best dynamic performance is achieved by connecting R_{EXT} in series (for $R_F > 1\text{M}\Omega$), or in parallel (for $R_F < 1\text{M}\Omega$), with the internal resistor as shown in Figure 2. Placing the external resistor in parallel with the internal resistor requires the DIP package. These connections take advantage of on-chip capacitive guarding of the internal resistor, which improves dynamic performance. For values of R_F less than $1\text{M}\Omega$, an external capacitor, C_{EXT} , should be connected in parallel with R_F (see Figure 2). This capacitor eliminates gain peaking and prevents instability. The value of C_{EXT} can be read from the table in Figure 2.

LIGHT SOURCE POSITIONING

The OPT202 is 100% tested with a light source that uniformly illuminates the full area of the integrated circuit, including the op amp. Although all IC amplifiers are light-sensitive to some degree, the OPT202 op amp circuitry is designed to

minimize this effect. Sensitive junctions are shielded with metal, and differential stages are cross-coupled. Furthermore, the photodiode area is very large relative to the op amp input circuitry making these effects negligible.

If your light source is focused to a small area, be sure that it is properly aimed to fall on the photodiode. If a narrowly focused light source were to miss the photodiode area and fall only on the op amp circuitry, the OPT202 would not perform properly. The large (0.090×0.090 inch) photodiode area allows easy positioning of narrowly focused light sources. The photodiode area is easily visible—it appears very dark compared to the surrounding active circuitry.

The incident angle of the light source also affects the apparent sensitivity in uniform irradiance. For small incident angles, the loss in sensitivity is simply due to the smaller effective light gathering area of the photodiode (proportional to the cosine of the angle). At a greater incident angle, light is diffused by the side of the package. These effects are shown in the typical performance curve "Response vs Incident Angle."

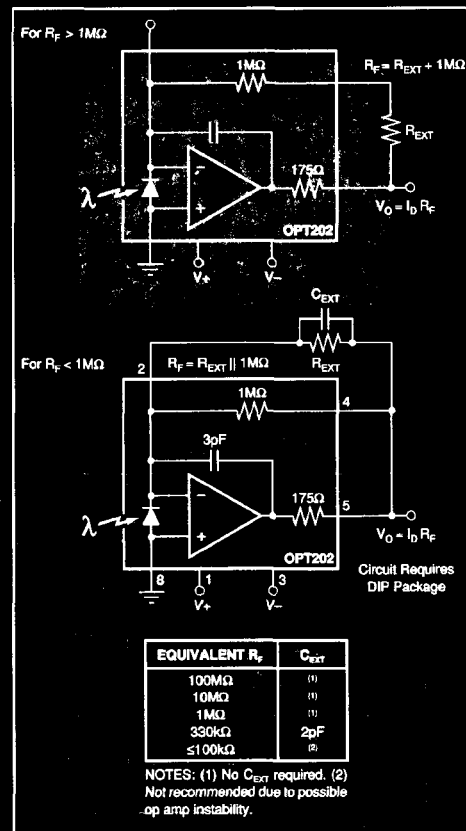

FIGURE 2. Using External Feedback Resistor.

Or, Call Customer Service at 1-800-548-6132 (USA Only)

DARK ERRORS

The dark errors in the specification table include all sources. The dominant error source is the input offset voltage of the op amp. Photodiode dark current and input bias current of the op amp are in the 2pA range and contribute virtually no offset error at room temperature. Dark current and input bias current double for each 10°C above 25°C. At 70°C, the error current can be approximately 100pA. This would produce a 1mV offset with $R_F = 10M\Omega$. The OPT202 is useful with feedback resistors of 100MΩ or greater at room temperature. The dark output voltage can be trimmed to zero with the optional circuit shown in Figure 3.

When used with very large feedback resistors, tiny leakage currents on the circuit board can degrade the performance of the OPT202. Careful circuit board design and clean assembly procedures will help achieve best performance. A "guard ring" on the circuit board can help minimize leakage to the critical non-inverting input (pin 2). This guard ring should encircle pin 2 and connect to Common, pin 8.

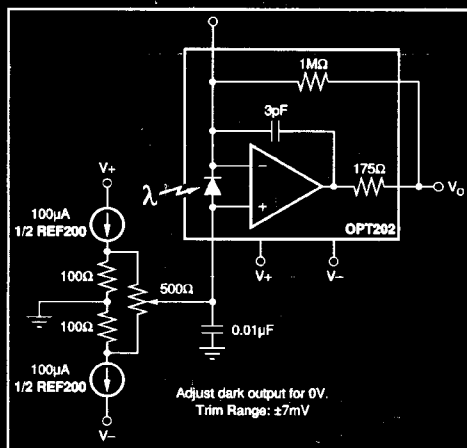

FIGURE 3. Dark Error (Offset) Adjustment Circuit.

LINEARITY PERFORMANCE

Current output of the photodiode is very linear with radiant power throughout a wide range. Nonlinearity remains below approximately 0.01% up to 100μA photodiode current. The photodiode can produce output currents of 10mA or greater with high radiant power, but nonlinearity increases to several percent in this region.

This very linear performance at high radiant power assumes that the full photodiode area is uniformly illuminated. If the light source is focused to a small area of the photodiode, nonlinearity will occur at lower radiant power.

DYNAMIC RESPONSE

Using the internal 1MΩ resistor, the dynamic response of the photodiode/op amp combination can be modeled as a

simple R/C circuit with a -3dB cutoff frequency of 50kHz. This yields a rise time of approximately 10μs (10% to 90%). Dynamic response is not limited by op amp slew rate. This is demonstrated by the dynamic response oscilloscope photographs showing virtually identical large-signal and small-signal response.

Dynamic response will vary with feedback resistor value as shown in the typical performance curve "Voltage Output Responsivity vs Frequency." Rise time (10% to 90%) will vary according to the -3dB bandwidth produced by a given feedback resistor value—

$$t_R \approx \frac{0.35}{f_c} \quad (1)$$

where:

t_R is the rise time (10% to 90%)

f_c is the -3dB bandwidth

NOISE PERFORMANCE

Noise performance of the OPT202 is determined by the op amp characteristics in conjunction with the feedback components and photodiode capacitance. The typical performance curve "Output Noise Voltage vs Measurement Bandwidth" shows how the noise varies with R_F and measured bandwidth (1Hz to the indicated frequency). The signal bandwidth of the OPT202 is indicated on the curves. Noise can be reduced by filtering the output with a cutoff frequency equal to the signal bandwidth.

Output noise increases in proportion to the square-root of the feedback resistance, while responsivity increases linearly with feedback resistance. So best signal-to-noise ratio is achieved with large feedback resistance. This comes with the trade-off of decreased bandwidth.

The noise performance of a photodetector is sometimes characterized by Noise Effective Power (NEP). This is the radiant power which would produce an output signal equal to the noise level. NEP has the units of radiant power (watts). The typical performance curve "Noise Effective Power vs Measurement Bandwidth" shows how NEP varies with R_F and measurement bandwidth.

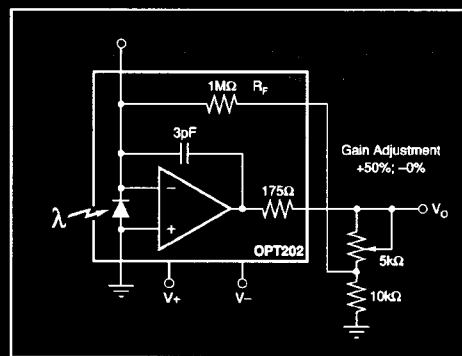

FIGURE 4. Responsivity (Gain) Adjustment Circuit.



For Immediate Assistance, Contact Your Local Salesperson

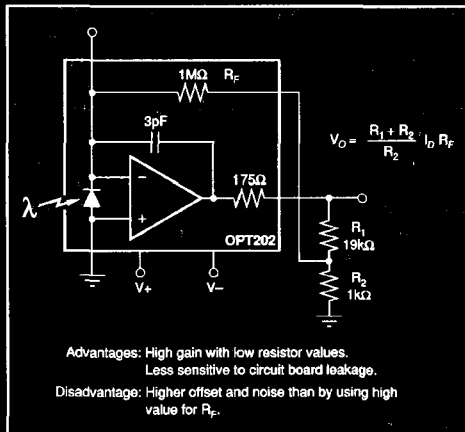

FIGURE 5. "T" Feedback Network.

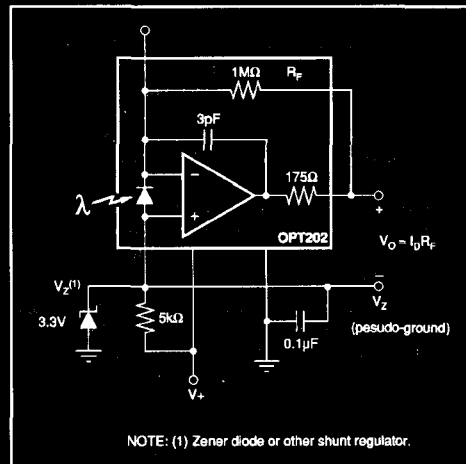

FIGURE 7. Single Power Supply Operation.

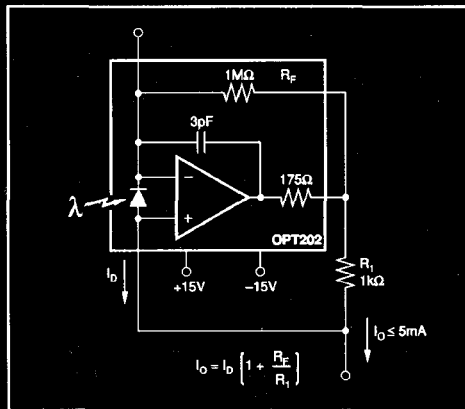

FIGURE 6. Current Output Circuit.

Other application circuits can be seen in the OPT209 data sheet.

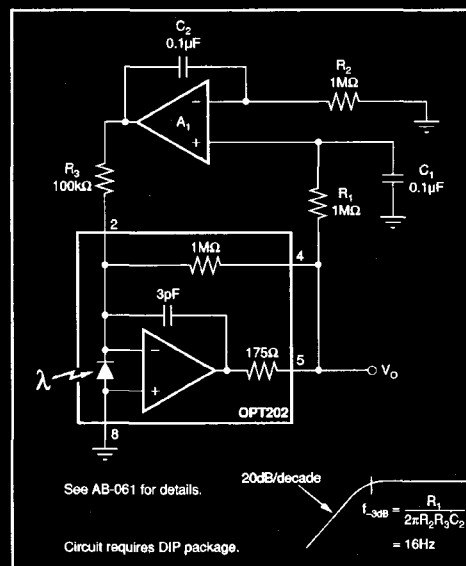

FIGURE 8. DC Restoration Rejects Unwanted Steady-State Background Light.