

# OPA688M UNITY-GAIN-STABLE WIDEBAND VOLTAGE LIMITING AMPLIFIER

SGLS144B – APRIL 2003 – DECEMBER 2006

## features

- High Linearity Near Limiting
- Fast Recovery from Overdrive: 2.4 ns
- Limiting Voltage Accuracy:  $\pm 15$  mV
- $-3$ dB Bandwidth ( $G = +1$ ): 450 MHz
- Slew Rate: 1000 V/ $\mu$ s
- $\pm 5$ -V and 5-V Supply Operation
- Unity Gain Version of the OPA689

- IF Limiting Amplifiers
- AM Signal Generation
- Non-Linear Analog Signal Processing
- High Speed Comparators

## applications

- Fast Limiting ADC Input Buffers
- CCD Pixel Clock Stripping
- Video Sync Stripping
- HF Mixers

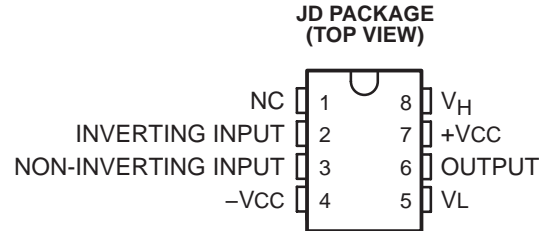

NC - No internal connection

## description

The OPA688 is a wideband, unity gain stable voltage-feedback op amp that offers bipolar output voltage limiting. Two buffered limiting voltages take control of the output when it attempts to drive beyond these limits. This new output limiting architecture holds the limiter offset error to  $\pm 15$  mV. The op amp operates linearly to within 30 mV of the output limit voltages.

The combination of narrow nonlinear range and low limiting offset allows the limiting voltages to be set within 100 mV of the desired linear output range. A fast 2.4-ns recovery from limiting ensures that overdrive signals will be transparent to the signal channel. Implementing the limiting function at the output, as opposed to the input, gives the specified limiting accuracy for any gain, and allows the OPA688 to be used in all standard op amp applications.

Non-linear analog signal processing will benefit from the OPA688's sharp transition from linear operation to output limiting. The quick recovery time supports high-speed applications.

The OPA688M is available in an industry standard pinout CDIP-8 package. For higher gain, or transimpedance applications requiring output limiting with fast recovery, consider the OPA689M.

## ORDERING INFORMATION†

T <sub>A</sub>	PACKAGE	ORDERABLE PART NUMBER	TOP-SIDE MARKING
-55°C to 125°C	CDIP - JD    Tube	OPA688MJD	OPA688MJD

† Package drawings, standard packing quantities, thermal data, symbolization, and PCB design guidelines are available at [www.ti.com/sc/package](http://www.ti.com/sc/package).



Please be aware that an important notice concerning availability, standard warranty, and use in critical applications of Texas Instruments semiconductor products and disclaimers thereto appears at the end of this data sheet.

PRODUCTION DATA information is current as of publication date. Products conform to specifications per the terms of Texas Instruments standard warranty. Production processing does not necessarily include testing of all parameters.



POST OFFICE BOX 655303 • DALLAS, TEXAS 75265

Copyright © 2006, Texas Instruments Incorporated

# OPA688M UNITY-GAIN-STABLE WIDEBAND VOLTAGE LIMITING AMPLIFIER

SGLS144B – APRIL 2003 – DECEMBER 2006

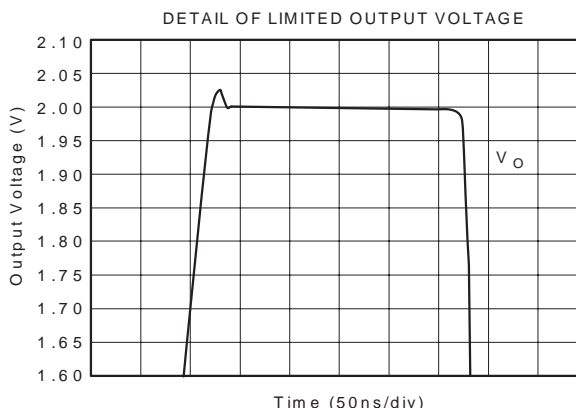
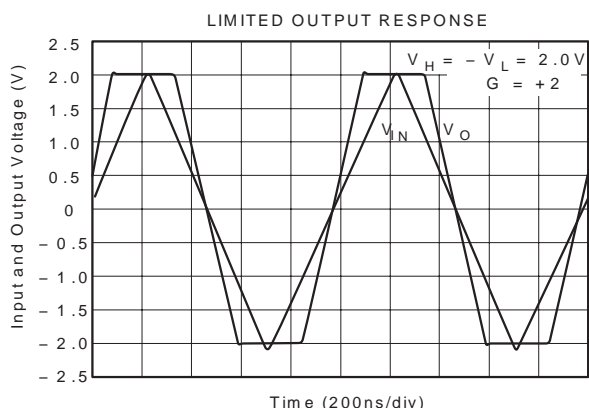

## absolute maximum ratings over operating free-air temperature (unless otherwise noted)†

Power supply	±6.5 V
Common-mode input voltage, $V_{ID}$	± $V_{CC}$
Differential input voltage, $V_{ID}$	± $V_{CC}$
Limiter voltage range	±( $V_S - 0.7$ V)
Operating free-air temperature range, $T_A$	-55°C to 125°C
Storage temperature range, $T_{stg}$	-65°C to 150°C
Lead temperature 1,6 mm (1/16 inch) from case for 10 seconds	300°C
Junction temperature, $T_J$	150°C

† Stresses beyond those listed under “absolute maximum ratings” may cause permanent damage to the device. These are stress ratings only, and functional operation of the device at these or any other conditions beyond those indicated under “recommended operating conditions” is not implied. Exposure to absolute-maximum-rated conditions for extended periods may affect device reliability.

## recommended operating conditions

		MIN	NOM	MAX	UNIT
Operating voltage	Split-Rail Operation		±5	±6	V
	Single-Supply Operation		5	12	
Operating free-air temperature		-55		125	°C

**OPA688M**  
**UNITY-GAIN-STABLE WIDEBAND**  
**VOLTAGE LIMITING AMPLIFIER**

SGLS144B – APRIL 2003 – DECEMBER 2006

electrical characteristics,  $V_{CC} = \pm 5\text{ V}$ ,  $V_{ICM} = 0\text{ V}$ ,  $R_L = 500\ \Omega$ , limiter pins open (unless otherwise noted) (see Note 1)

PARAMETER	TEST CONDITIONS	MIN	TYP	MAX	UNIT	
<b>AC Performance (see Figure 1)</b>						
Small signal bandwidth	$V_O < 0.2\text{ Vp-p}$ , $G = +1$ , $R_F = 25\ \Omega$		450		MHz	
	$V_O < 0.2\text{ Vp-p}$ , $G = +2$		215			
	$V_O < 0.2\text{ Vp-p}$ , $G = -1$		215			
Gain-bandwidth product ( $G \geq 5$ )	$V_O < 0.2\text{ Vp-p}$		250		MHz	
Bandwidth for 0.1 dB gain flatness	$V_O = 0.2\text{ V}$		30		MHz	
Gain peaking	$G = +1$ , $V_O < 0.2\text{ Vp-p}$ , $R_F = 25\ \Omega$		11		dB	
Large signal bandwidth	$V_O = 4\text{ Vp-p}$ , $V_H = -V_L = 2.5\text{ V}$		145		MHz	
Slew rate	4 V step, $V_H = -V_L = 2.5\text{ V}$		1000		V/ $\mu\text{s}$	
Rise and fall time	0.2 V step		1.9		ns	
Settling time to 0.05%	2 V step		8		ns	
Spurious free dynamic range	$V_O = 2\text{ Vp-p}$ , $f = 5\text{ MHz}$		66		dB	
Differential gain	$R_L = 500\ \Omega$ , NTSC, PAL		0.02		%	
Differential phase	$R_L = 500\ \Omega$ , NTSC, PAL		0.01		$^\circ$	
Input noise, voltage noise density	$f \geq 1\text{ MHz}$		6.3		nV/ $\sqrt{\text{Hz}}$	
Input noise, current noise density	$f \geq 1\text{ MHz}$		2		pA/ $\sqrt{\text{Hz}}$	
<b>DC Performance</b>						
Open-loop voltage gain (AVOL)	$V_O = \pm 0.5\text{ V}$	$T_A = 25^\circ\text{C}$	46	52	dB	
		$T_A = \text{Full range}$	43			
Input offset voltage ( $V_{IO}$ )		$T_A = 25^\circ\text{C}$		$\pm 2$	$\pm 8$	mV
		$T_A = \text{Full range}$			$\pm 11$	
Input bias current ( $I_{IB}$ ) (See Note 2)		$T_A = 25^\circ\text{C}$		$\pm 6$	$\pm 12$	$\mu\text{A}$
		$T_A = \text{Full range}$			$\pm 20$	
Input offset current ( $I_{IO}$ )		$T_A = 25^\circ\text{C}$		$\pm 0.3$	$\pm 2$	$\mu\text{A}$
		$T_A = \text{Full range}$			$\pm 4$	
<b>Input</b>						
Common-mode rejection ratio (CMRR)	$V_{ICM} = \pm 0.5\text{ V}$ , Input referred	$T_A = 25^\circ\text{C}$	50	57	dB	
		$T_A = \text{Full range}$	47			
Common-mode input voltage range ( $V_{ICR}$ ) (See Note 3)		$T_A = 25^\circ\text{C}$	$\pm 3.2$	$\pm 3.3$	V	
		$T_A = \text{Full range}$	$\pm 3.1$			
Input impedance, differential mode			0.4 1		M $\Omega$ pF	
Input impedance, common mode			1 1		M $\Omega$ pF	

# OPA688M

## UNITY-GAIN-STABLE WIDEBAND VOLTAGE LIMITING AMPLIFIER

SGLS144B – APRIL 2003 – DECEMBER 2006

electrical characteristics,  $V_{CC} = \pm 5\text{ V}$ ,  $V_{ICM} = 0\text{ V}$ ,  $R_L = 500\ \Omega$ , limiter pins open (unless otherwise noted) (see Note 1) (continued)

PARAMETER	TEST CONDITIONS	MIN	TYP	MAX	UNIT	
<b>Output</b>						
Output voltage range ( $V_{OH}$ , $V_{OL}$ )	$V_H = 4.3\text{ V}$ , $V_L = -4.3\text{ V}$ , $R_L \geq 500\ \Omega$	$T_A = 25^\circ\text{C}$	$\pm 3.9$	$\pm 4.1$	V	
		$T_A = \text{Full range}$	$\pm 3.7$			
Current output, sourcing ( $I_{OH}$ )	$V_H = 4.3\text{ V}$ , $V_L = -4.3\text{ V}$ , $R_L = 20\ \Omega$	$T_A = 25^\circ\text{C}$	90	105	mA	
		$T_A = \text{Full range}$	80			
Current output, sinking ( $I_{OL}$ )	$V_H = 4.3\text{ V}$ , $V_L = -4.3\text{ V}$ , $R_L = 20\ \Omega$	$T_A = 25^\circ\text{C}$	-70	-85	mA	
		$T_A = \text{Full range}$	-60			
Closed-loop output impedance	$G = +1$ , $R_F = 25\ \Omega$ , $f < 100\text{ kHz}$		0.2		$\Omega$	
<b>Power Supply</b>						
Operating voltage ( $V_{CC}$ )			$\pm 5$	$\pm 6$	V	
Quiescent current ( $I_{CC}$ )		$T_A = 25^\circ\text{C}$	14	15.8	17	mA
		$T_A = \text{Full range}$	11		20	
Power supply rejection ratio (PSRR)	Input referred, $V_S = \pm 4.5\text{ V to } \pm 5.5\text{ V}$	$T_A = 25^\circ\text{C}$	58	70		dB
		$T_A = \text{Full range}$	55			dB
<b>Output Voltage Limiters (pins 5 and 8)</b>						
Default output limited voltage	Limiter pins open	$T_A = 25^\circ\text{C}$	$\pm 3$	$\pm 3.3$	V	
		$T_A = \text{Full range}$	$\pm 2.8$			
Limiter output offset voltage	$(V_O - V_H)$ or $(V_O - V_L)$	$T_A = \text{Full range}$		$\pm 15$	$\pm 50$	mV
Limiter input bias current magnitude (See Note 4)	$V_O = 0\text{ V}$	$T_A = 25^\circ\text{C}$	35	54	65	$\mu\text{A}$
		$T_A = \text{Full range}$	31		70	
Limiter input impedance			2 1		$\text{M}\Omega$ $\text{pF}$	
Limiter feedthrough (See Note 5)	$f = 5\text{ MHz}$		-60		dB	
Maximum limiter voltage				$\pm 4.3$	V	
Minimum limiter voltage separation		400			mV	
Op amp bias current shift (See Note 2)			3		$\mu\text{A}$	
Limiter small signal bandwidth	$V_I = \pm 2\text{ V}$ , $V_O < 0.02\text{ Vp-p}$		450		MHz	
Limiter slew rate (See Note 6)			100		$\text{V}/\mu\text{s}$	
Limiter step response, overshoot	$V_I = \pm 2\text{ V}$		250		mV	
Limiter step response, recovery time	$V_I = \pm 2\text{ V}$		2.4		ns	
Linearity guardband (See Note 7)	$V_O = 2\text{ Vp-p}$ , $f = 5\text{ MHz}$		30		mV	

- NOTES: 1. All typical limits are at  $T_A = 25^\circ\text{C}$  unless otherwise specified.  
 2. Current is considered positive out of node.  
 3. CMIR tested as  $< 3\text{ dB}$  degradation from minimum CMRR at specified limits.  
 4.  $I_{VH}$  ( $V_H$  bias current) is positive, and  $I_{VL}$  ( $V_L$  bias current) is negative, under these conditions. See Note 3, Figure 30 and Figure 37.  
 5. Limiter feedthrough is the ratio of the output magnitude to the sinewave added to  $V_H$  (or  $V_L$ ) when  $V_{IN} = 0$ .  
 6.  $V_H$  slew rate conditions are:  $V_{IN} = +2\text{ V}$ ,  $G = +2$ ,  $V_L = -2\text{ V}$ ,  $V_H = \text{step between } 2\text{ V and } 0\text{ V}$ .  $V_L$  slew rate conditions are similar.  
 7. Linearity Guardband is defined for an output sinusoid ( $f = 5\text{ MHz}$ ,  $V_O = 0\text{ VDC } \pm 1\text{ VP-P}$ ) centered between the limiter levels ( $V_H$  and  $V_L$ ). It is the difference between the limiter level and the peak output voltage where SFDR decreases by 3dB (see Figure 38).



# OPA688M

## UNITY-GAIN-STABLE WIDEBAND VOLTAGE LIMITING AMPLIFIER

SGLS144B – APRIL 2003 – DECEMBER 2006

electrical characteristics,  $V_{CC} = 5\text{ V}$ ,  $V_{ICM} = 2.5\text{ V}$ ,  $R_L = 500\ \Omega$ , limiter pins open (unless otherwise noted) (see Note 1)

PARAMETER	TEST CONDITIONS	MIN	TYP	MAX	UNIT	
<b>AC Performance (see Figure 2)</b>						
Small signal bandwidth	$V_O < 0.2\text{ V}_{p-p}$ , $G = +1$ , $R_F = 25\ \Omega$		375		MHz	
	$V_O < 0.2\text{ V}_{p-p}$ , $G = +2$		200			
	$V_O < 0.2\text{ V}_{p-p}$ , $G = -1$		190			
Gain bandwidth product ( $G \geq +5$ )	$V_O < 0.2\text{ V}_{p-p}$		230		MHz	
Gain peaking	$V_O < 0.2\text{ V}_{p-p}$ , $G = +1$ , $R_F = 25\ \Omega$		10		dB	
Bandwidth for 0.1 dB gain flatness	$V_O < 0.2\text{ V}_{p-p}$		30		MHz	
Large signal bandwidth	$V_O < 2\text{ V}_{p-p}$		200		MHz	
Slew rate	2 V step		820		V/ $\mu$ s	
Rise and fall time	0.2 V step		2.3		ns	
Settling time to 0.05%	1 V step		12		ns	
Spurious free dynamic range	$V_O = 2\text{ V}_{p-p}$ , $f = 5\text{ MHz}$		64		dB	
Input noise, voltage noise density	$f > 1\text{ MHz}$		6.3		nV/ $\sqrt{\text{Hz}}$	
Input noise, current noise density	$f > 1\text{ MHz}$		2		pA/ $\sqrt{\text{Hz}}$	
<b>DC Performance</b>						
Open-loop voltage gain (AVOL)	$V_O = \pm 0.4\text{ V}$	$T_A = 25^\circ\text{C}$	46	52	dB	
		$T_A = \text{Full range}$	43			
Input offset voltage ( $V_{IO}$ )		$T_A = 25^\circ\text{C}$		$\pm 2$	$\pm 8$	mV
		$T_A = \text{Full range}$			$\pm 11$	
Input bias current ( $I_{IB}$ )		$T_A = 25^\circ\text{C}$		$\pm 6$	$\pm 12$	$\mu$ A
		$T_A = \text{Full range}$			$\pm 20$	
Input offset current ( $I_{IO}$ )		$T_A = 25^\circ\text{C}$		$\pm 0.3$	$\pm 2$	$\mu$ A
		$T_A = \text{Full range}$			$\pm 4$	
<b>Input</b>						
Common-mode rejection ratio (CMRR)	$V_{ICM} = \pm 0.5\text{ V}$ , Input referred	$T_A = 25^\circ\text{C}$	48	55	dB	
		$T_A = \text{Full range}$	45			
Common-mode input voltage range ( $V_{ICR}$ ) (See Note 3)		$T_A = 25^\circ\text{C}$	$V_{ICM} \pm 0.7\text{ V}$	$V_{ICM} \pm 0.8\text{ V}$	V	
		$T_A = \text{Full range}$	$V_{ICM} \pm 0.6\text{ V}$			
Input impedance, differential mode			0.4 1		M $\Omega$ pF	
Input impedance, common mode			1 1		M $\Omega$ pF	
<b>Output</b>						
Output voltage range ( $V_{OH}$ , $V_{OL}$ )	$V_H = V_{ICM} + 1.8\text{ V}$ , $V_L = V_{ICM} - 1.8\text{ V}$ , $R_L \geq 500\ \Omega$	$T_A = 25^\circ\text{C}$	$V_{ICM} \pm 1.4\text{ V}$	$V_{ICM} \pm 1.6\text{ V}$	V	
		$T_A = \text{Full range}$	$V_{ICM} \pm 1.3\text{ V}$			
Current output, sourcing ( $I_{OH}$ )	$V_{CC} = \pm 2.5\text{ V}$ , $R_L = 20\ \Omega$	$T_A = 25^\circ\text{C}$	60	70	mA	
		$T_A = \text{Full range}$	50			
Current output, sinking ( $I_{OL}$ )	$V_{CC} = \pm 2.5\text{ V}$ , $R_L = 20\ \Omega$	$T_A = 25^\circ\text{C}$	-50	-60	mA	
		$T_A = \text{Full range}$	-40			
Closed-loop output impedance	$G = +1$ , $R_F = 25\ \Omega$ , $f < 100\text{ kHz}$		0.2		$\Omega$	

# OPA688M

## UNITY-GAIN-STABLE WIDEBAND VOLTAGE LIMITING AMPLIFIER

SGLS144B – APRIL 2003 – DECEMBER 2006

electrical characteristics,  $V_{CC} = 5\text{ V}$ ,  $V_{ICM} = 2.5\text{ V}$ ,  $R_L = 500\ \Omega$ , limiter pins open (unless otherwise noted) (see Note 1) (continued)

PARAMETER	TEST CONDITIONS	MIN	TYP	MAX	UNIT	
<b>Power Supply</b>						
Operating voltage ( $V_{CC}$ )			5	12	V	
Quiescent current ( $I_{CC}$ )		$T_A = 25^\circ\text{C}$	11	13	15	mA
		$T_A = \text{Full range}$	9		16.5	
Power supply rejection ratio (PSRR)	Input referred, $V_{CC} = \pm 2\text{ V to } \pm 3\text{ V}$	$T_A = \text{Full range}$	55	70		dB
<b>Output Voltage Limiters (pins 5 and 8)</b>						
Default output limited voltage	Limiter pins open	$T_A = 25^\circ\text{C}$	$V_{ICM} \pm 0.6\text{ V}$	$V_{ICM} \pm 0.9\text{ V}$		V
		$T_A = \text{Full range}$	$V_{ICM} \pm 0.4\text{ V}$			V
Limiter output offset voltage	$(V_O - V_H)$ or $(V_O - V_L)$	$T_A = \text{Full range}$		$\pm 15$	$\pm 50$	mV
Limiter input bias current magnitude (See Note 4)	$V_O = 2.5\text{ V}$	$T_A = 25^\circ\text{C}$	0	35	65	$\mu\text{A}$
		$T_A = \text{Full range}$	0		85	
Limiter input bias current drift			30			nA/ $^\circ\text{C}$
Limiter input impedance			2 1			M $\Omega$ pF
Limiter feedthrough (See Note 5)	$f = 5\text{ MHz}$		-60			dB
Maximum limiter voltage					$V_{ICM} \pm 1.8$	V
Minimum limiter voltage separation		400				mV
Output bias current shift (See Note 2)			5			$\mu\text{A}$
Limiter small signal bandwidth	$V_I = V_{ICM} \pm 1.2\text{ V}$ , $V_O < 0.02\text{ Vp-p}$		300			MHz
Limiter slew rate (See Note 6)			20			V/ $\mu\text{s}$
Limiter step response, overshoot	$V_I = V_{ICM} \pm 1.2\text{ V}$		55			mV
Limiter step response, recovery time	$V_I = V_{ICM} \pm 1.2\text{ V}$		15			ns
Linearity guardband (See Note 7)	$V_O = 2\text{ Vp-p}$ , $f = 5\text{ MHz}$	30				mV

- NOTES: 1. All typical limits are at  $T_A = 25^\circ\text{C}$  unless otherwise specified.  
 2. Current is considered positive out of node.  
 3. CMIR tested as  $< 3\text{ dB}$  degradation from minimum CMRR at specified limits.  
 4.  $I_{VH}$  ( $V_H$  bias current) is positive, and  $I_{VL}$  ( $V_L$  bias current) is negative, under these conditions. See Note 3, Figure 31 and Figure 37.  
 5. Limiter feedthrough is the ratio of the output magnitude to the sinewave added to  $V_H$  (or  $V_L$ ) when  $V_{IN} = 0$ .  
 6.  $V_H$  slew rate conditions are:  $V_{IN} = V_{ICM} + 0.4\text{ V}$ ,  $G = +2$ ,  $V_L = V_{ICM} - 1.2\text{ V}$ ,  $V_H = \text{stepped between } V_{ICM} + 1.2\text{ V and } V_{ICM}$ .  $V_L$  slew rate conditions are similar.  
 7. Linearity Guardband is defined for an output sinusoid ( $f = 5\text{ MHz}$ ,  $V_O = 0\text{ VDC} \pm 1\text{ VP-P}$ ) centered between the limiter levels ( $V_H$  and  $V_L$ ). It is the difference between the limiter level and the peak output voltage where SFDR decreases by 3dB (see Figure 38).

**TYPICAL CHARACTERISTICS**

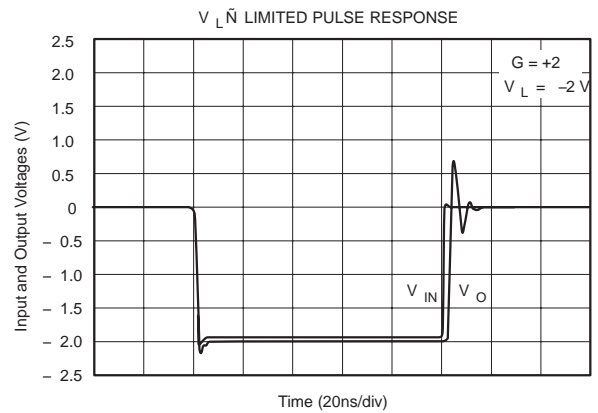
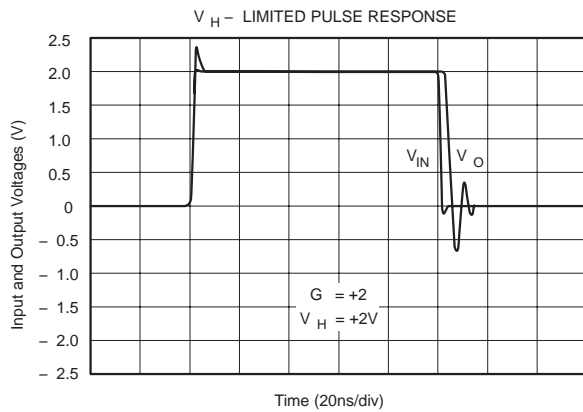
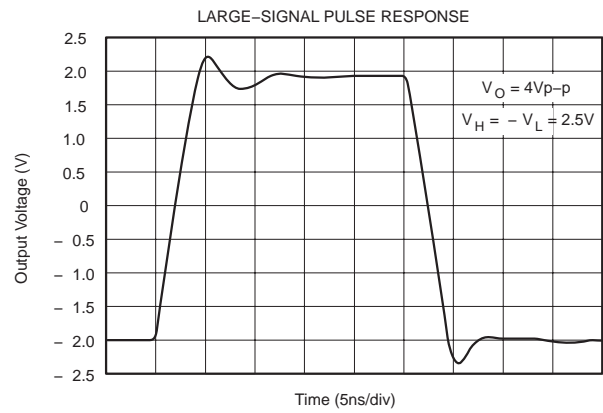
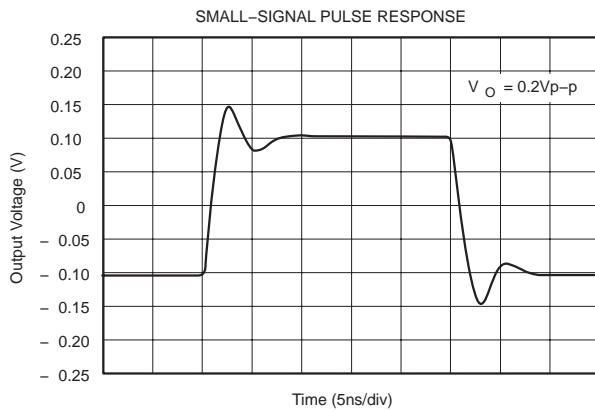
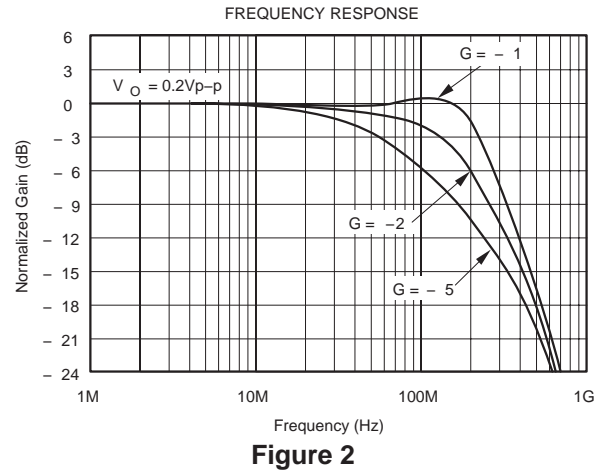
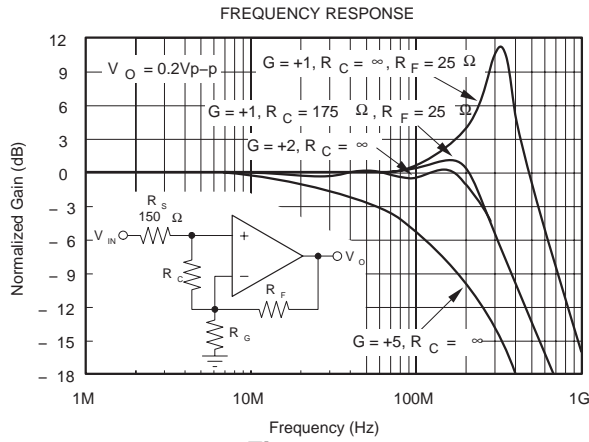

# OPA688M UNITY-GAIN-STABLE WIDEBAND VOLTAGE LIMITING AMPLIFIER

SGLS144B – APRIL 2003 – DECEMBER 2006

## TYPICAL CHARACTERISTICS

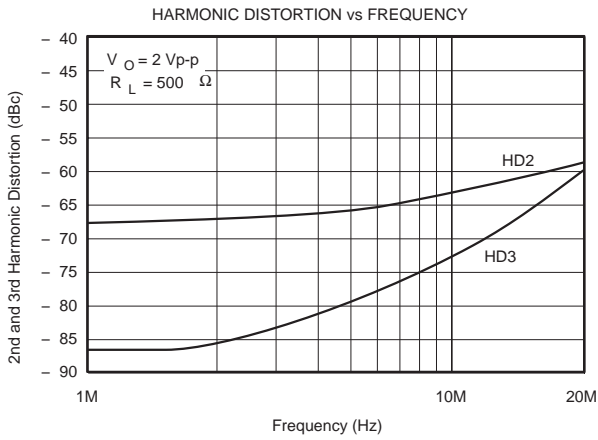

Figure 7

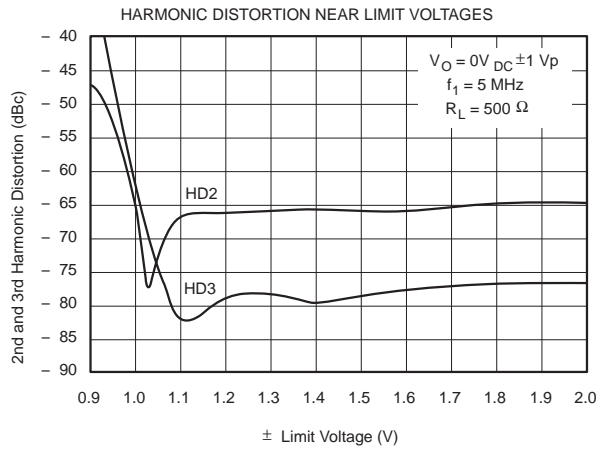

Figure 8

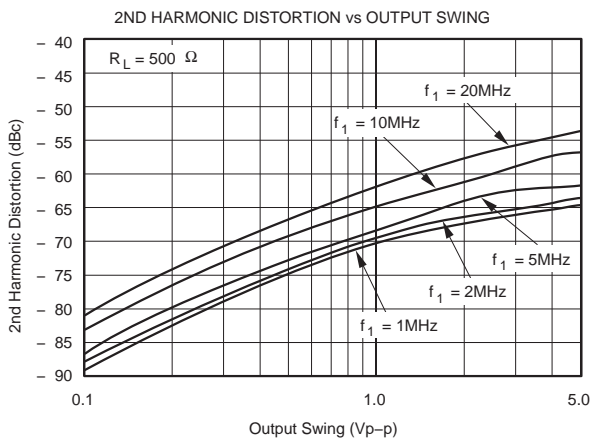

Figure 9

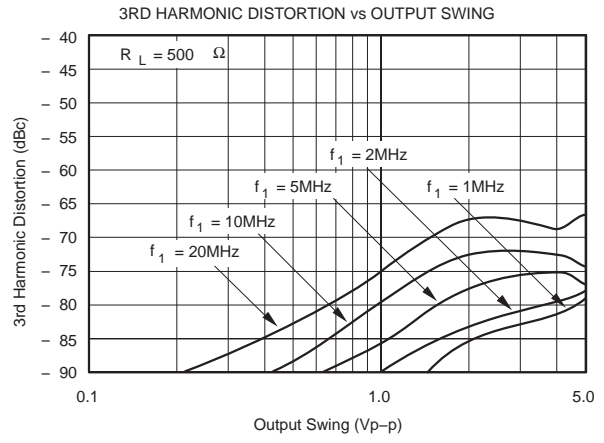

Figure 10

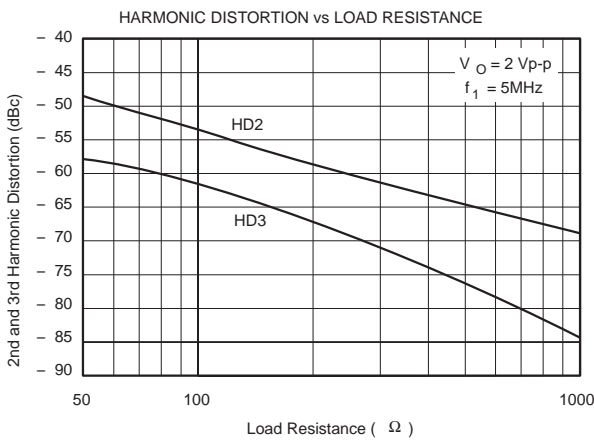

Figure 11

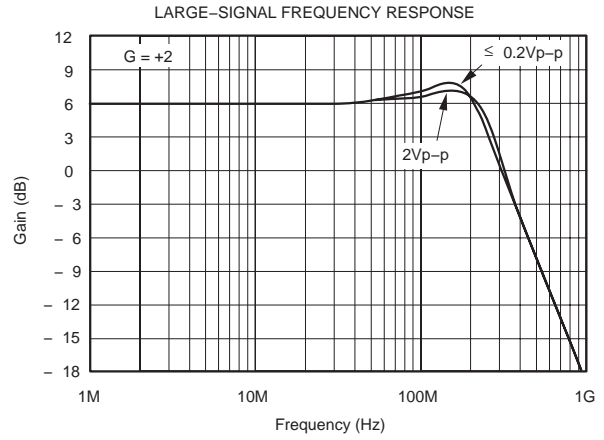
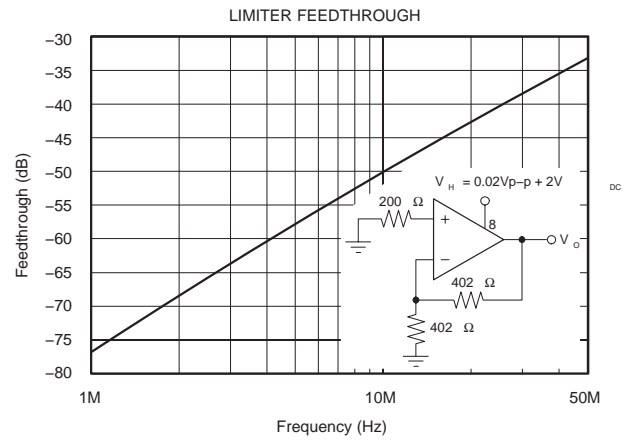
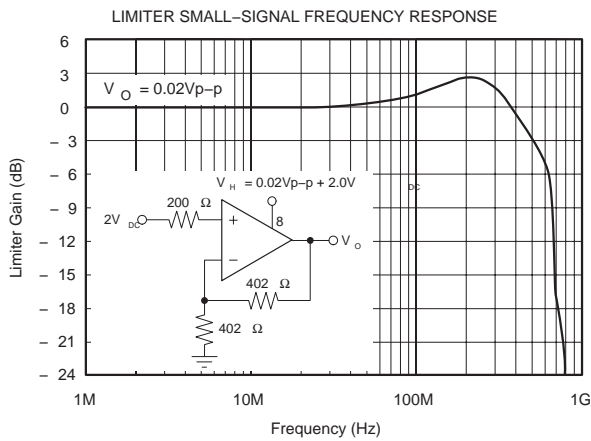
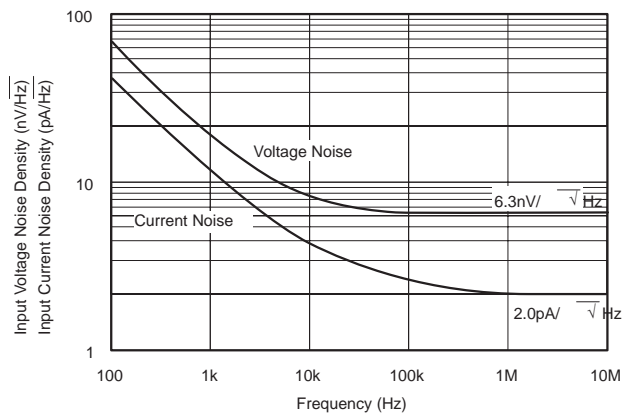
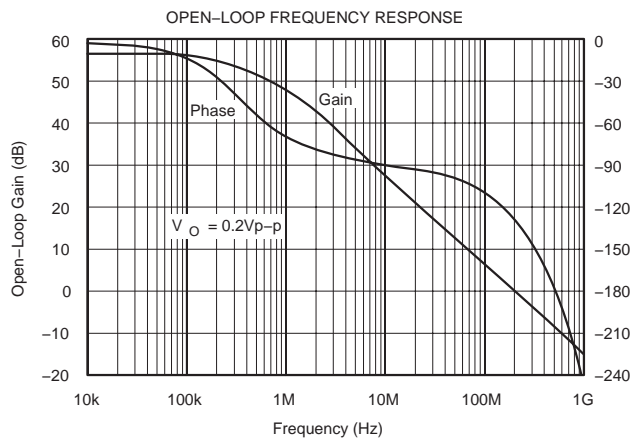
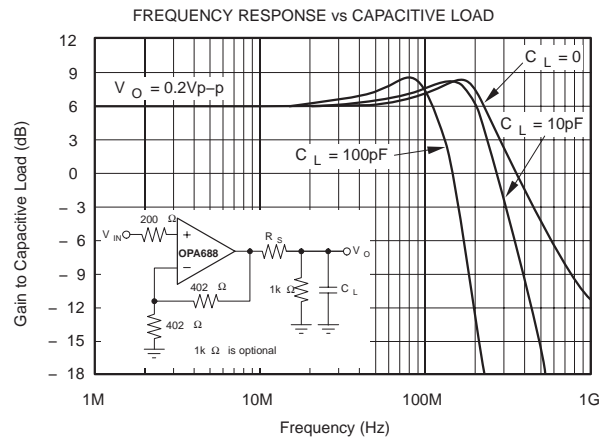
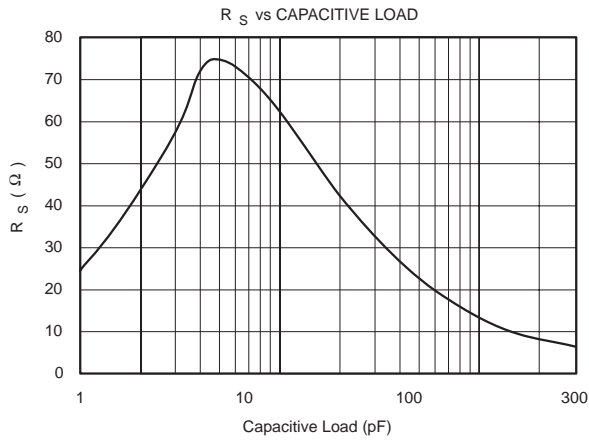

Figure 12



**TYPICAL CHARACTERISTICS**



**OPA688M**  
**UNITY-GAIN-STABLE WIDEBAND**  
**VOLTAGE LIMITING AMPLIFIER**

SGLS144B – APRIL 2003 – DECEMBER 2006

**TYPICAL CHARACTERISTICS**

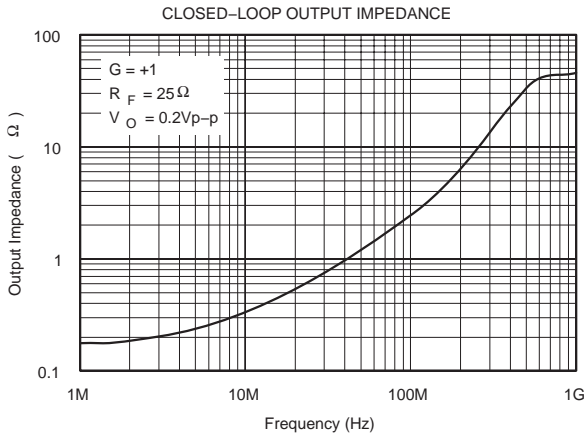

**Figure 19**

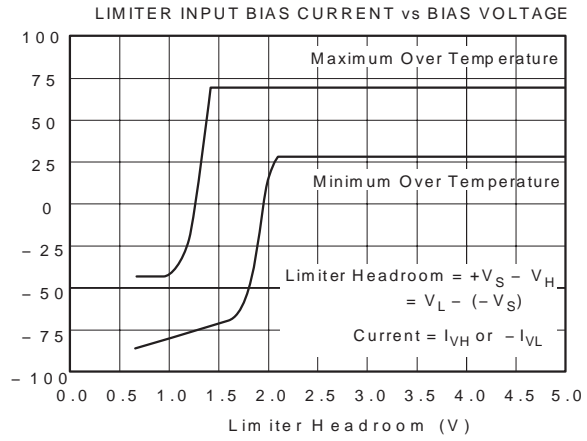

**Figure 20**

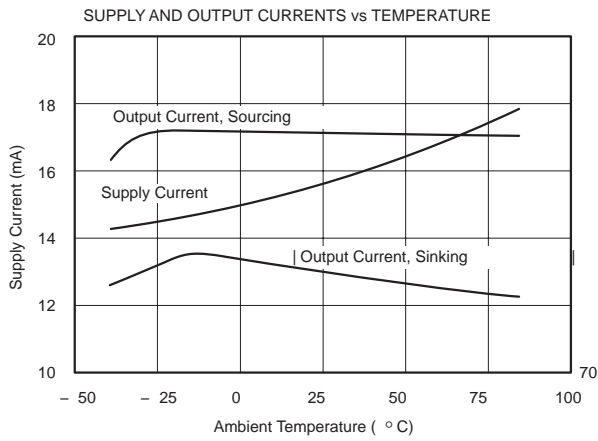

**Figure 21**

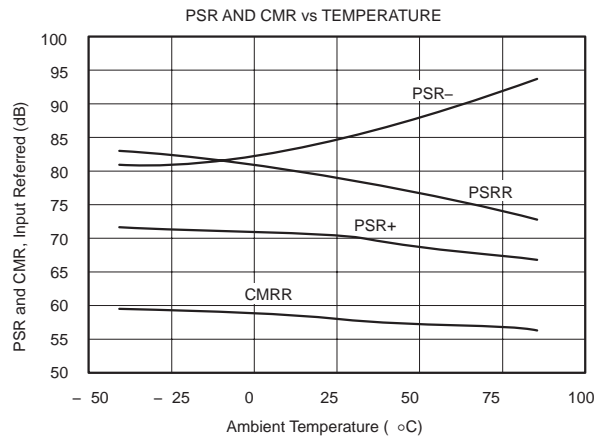

**Figure 22**

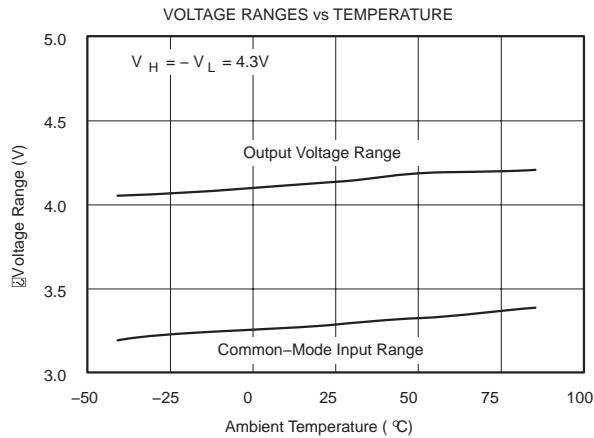

**Figure 23**



**TYPICAL CHARACTERISTICS**

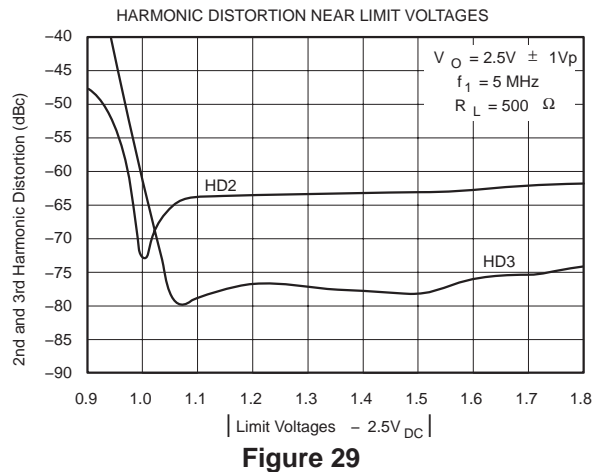
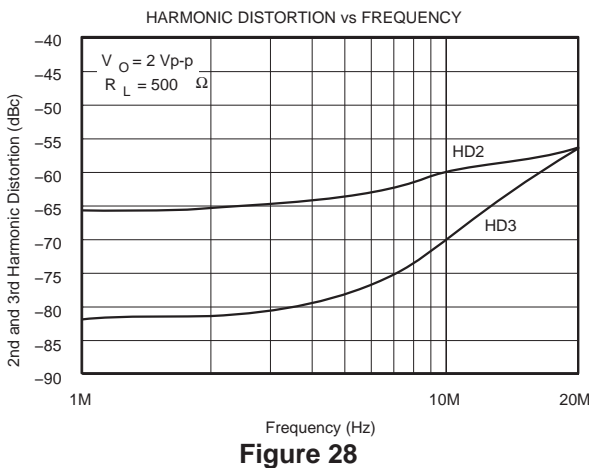
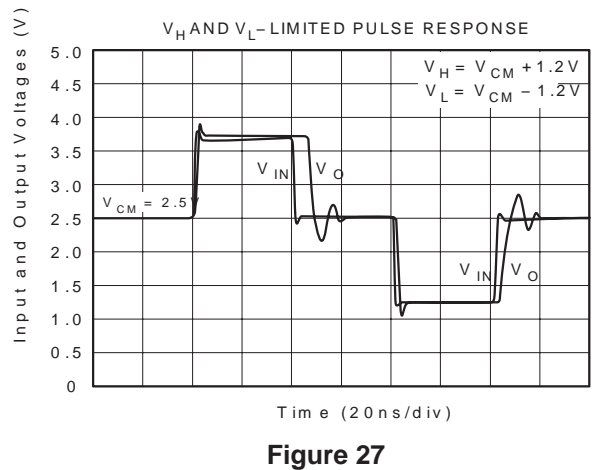
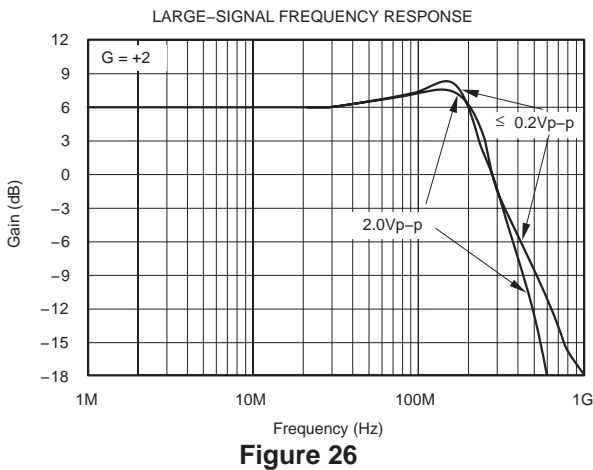
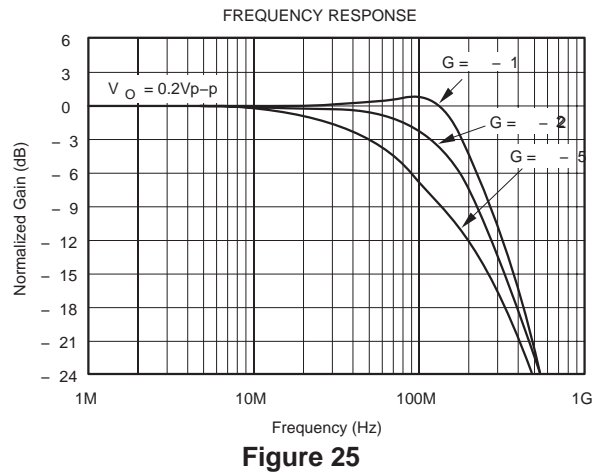
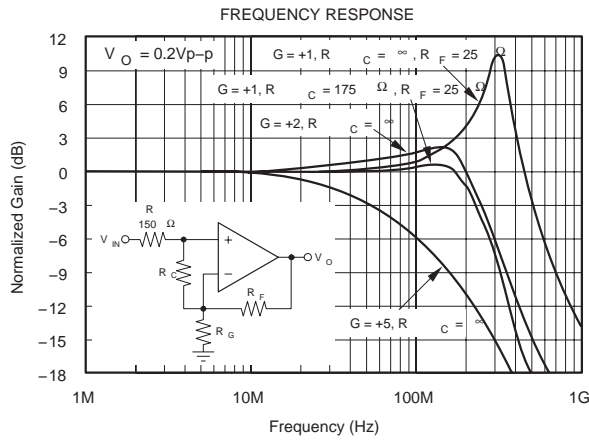

# OPA688M UNITY-GAIN-STABLE WIDEBAND VOLTAGE LIMITING AMPLIFIER

SGLS144B – APRIL 2003 – DECEMBER 2006

## APPLICATION INFORMATION

### dual-supply, non-inverting amplifier

Figure 30 shows a non-inverting gain amplifier for dual-supply operation. This circuit was used for AC characterization of the OPA688, with a 50-Ω source, which it matches, and a 500-Ω load. The power-supply bypass capacitors are shown explicitly in Figures 30 and 31, but will be assumed in the other figures. The limiter voltages ( $V_H$  and  $V_L$ ) and their bias currents ( $I_{VH}$  and  $I_{VL}$ ) have the polarities shown.

### single-supply, non-inverting amplifier

Figure 31 shows an AC-coupled, non-inverting gain amplifier for single +5V supply operation. This circuit was used for AC characterization of the OPA688, with a 50W source, which it matches, and a 500-Ω load. The power-supply bypass capacitors are shown explicitly in Figures 30 and 31, but will be assumed in the other figures. The limiter voltages ( $V_H$  and  $V_L$ ) and their bias currents ( $I_{VH}$  and  $I_{VL}$ ) have the polarities shown. Notice that the single-supply circuit can use three resistors to set  $V_H$  and  $V_L$ , where the dual-supply circuit usually uses four to reference the limit voltages to ground.

### limited output, ADC input driver

Figure 32 shows a simple ADC (Analog-to-Digital Converter) driver that operates on a single supply, and gives excellent distortion performance. The limit voltages track the input range of the converter, completely protecting against input overdrive.

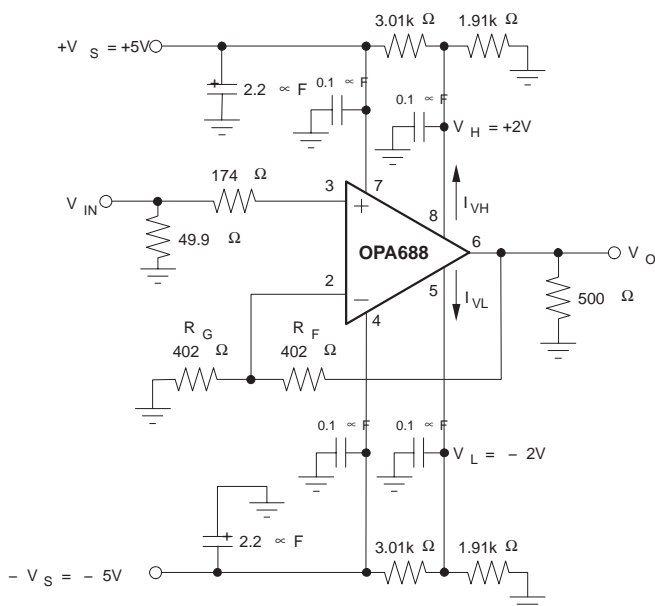
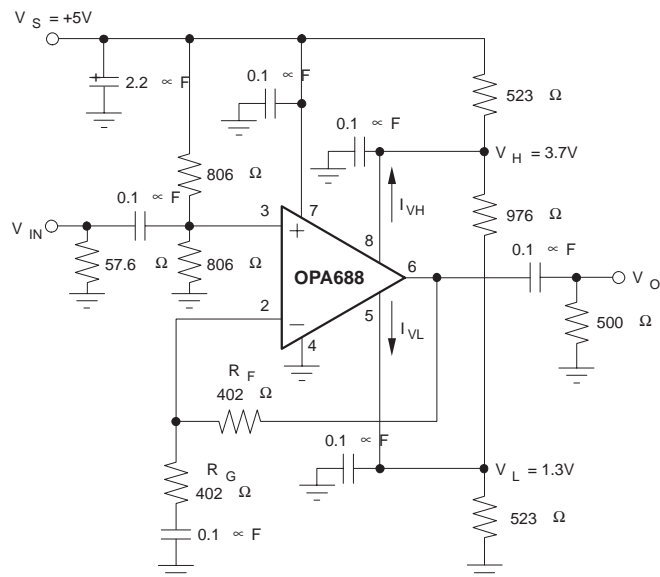
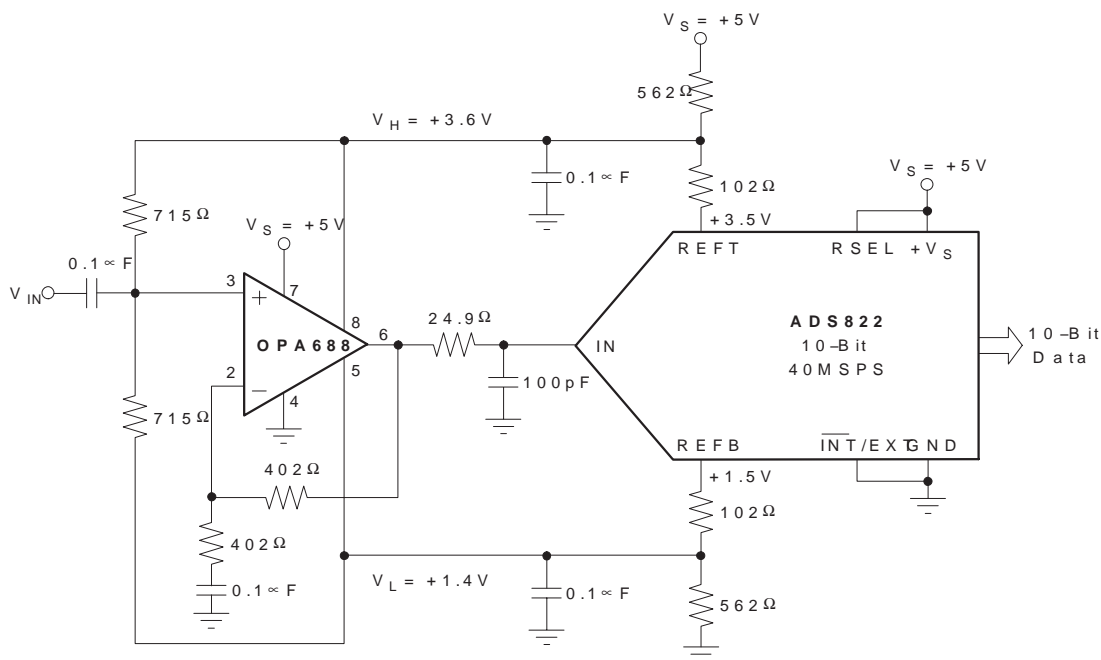

Figure 30. DC-Coupled, Dual Supply Amplifier



**Figure 31. AC-Coupled, Single Supply Amplifier**



**Figure 32. Single Supply, Limiting ADC Input Driver**

**precision half wave rectifier**

Figure 33 shows a half wave rectifier with outstanding precision and speed.  $V_H$  (pin 8) will default to a voltage between 3.1 and 3.8 V if left open, while the negative limit is set to ground.

# OPA688M

## UNITY-GAIN-STABLE WIDEBAND VOLTAGE LIMITING AMPLIFIER

SGLS144B – APRIL 2003 – DECEMBER 2006

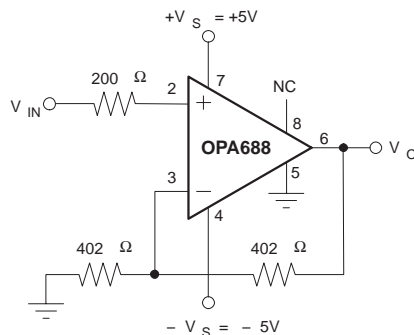

Figure 33. Precision Half Wave Rectifier

### very high speed Schmitt trigger

Figure 34 shows a very high-speed Schmitt trigger. The output levels are precisely defined, and the switching time is exceptional. The output voltage swings between  $\pm 2V$ .

### unity-gain buffer

Figure 35 shows a unity-gain voltage buffer using the OPA688. The feedback resistor ( $R_F$ ) isolates the output from any board inductance between pins 2 and 6. We recommend that

$R_F \times 24.9W$  for unity-gain buffer applications.  $R_C$  is an optional compensation resistor that reduces the peaking typically seen at  $G = +1$ . Choosing  $R_C = R_S + R_F$  gives a unity gain buffer with approximately the  $G = +2$  frequency response.

### DC restorer

Figure 36 shows a DC restorer using the OPA688 and OPA660. The OPA660's OTA amplifier is used as a Current Conveyor (CCII) in this circuit, with a current gain of 1.0.

When  $V_O$  tries to go below ground, CCII charges  $C_1$  through  $D_1$ , which restores the output back to ground.  $D_1$  adds a propagation delay to the restoration process, which then has an exponential decay with time constant  $R_1C_1/G$  ( $G = +2 =$  the OPA688 gain). When the signal is above ground, it decays to ground with a time constant of  $R_2C_1$ . The OPA688 output recovers very quickly from overdrive.

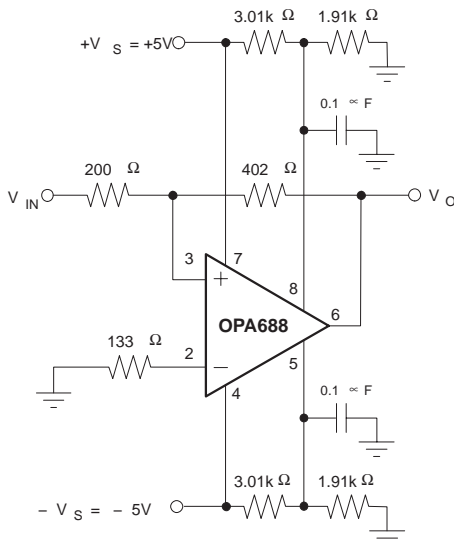

**Figure 34. Very High Speed Schmitt Trigger**

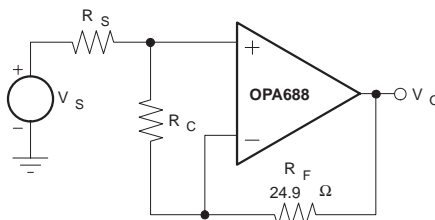

**Figure 35. Unity-Gain Buffer**

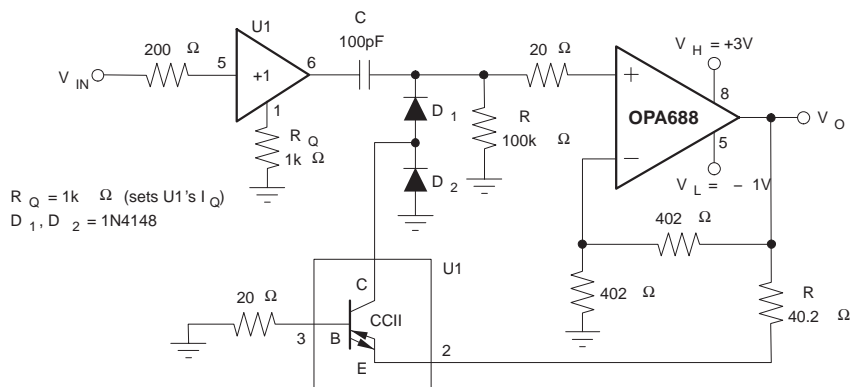

**Figure 36. DC Restorer**

# OPA688M

## UNITY-GAIN-STABLE WIDEBAND VOLTAGE LIMITING AMPLIFIER

SGLS144B – APRIL 2003 – DECEMBER 2006

---

### design-in tools

### applications support

The Texas Instruments web site (<http://www.ti.com>) has the latest data sheets and other design aids.

### theory of operation

The OPA688 is a voltage-feedback op amp that is unity-gain stable. The output voltage is limited to a range set by the voltage on the limiter pins (5 and 8). When the input tries to overdrive the output, the limiters take control of the output buffer. This avoids saturating any part of the signal path, giving quick overdrive recovery and excellent limiter accuracy at any signal gain.

The limiters have a very sharp transition from the linear region of operation to output limiting. This allows the limiter voltages to be set very near ( $< 100\text{mV}$ ) the desired signal range. The distortion performance is also very good near the limiter voltages.

### circuit layout

Achieving optimum performance with the high-frequency OPA688 requires careful attention to layout design and component selection. Recommended PCB layout techniques and component selection criteria are:

- a) **Minimize parasitic capacitance to any AC ground** for all of the signal I/O pins. Open a window in the ground and power planes around the signal I/O pins, and leave the ground and power planes unbroken elsewhere.
- b) **Provide a high quality power supply.** Use linear regulators, ground plane and power planes to provide power. Place high-frequency  $0.1\ \mu\text{F}$  decoupling capacitors  $< 0.2''$  away from each power-supply pin. Use wide, short traces to connect to these capacitors to the ground and power planes. Also use larger ( $2.2\ \mu\text{F}$  to  $6.8\ \mu\text{F}$ ) high-frequency decoupling capacitors to bypass lower frequencies. They may be somewhat further from the device, and be shared among several adjacent devices.
- c) **Place external components close** to the OPA688. This minimizes inductance, ground loops, transmission line effects and propagation delay problems. Be extra careful with the feedback ( $R_F$ ), input and output resistors.
- d) **Use high-frequency components** to minimize parasitic elements. Resistors should be a very low reactance type. Surface-mount resistors work best and allow a tighter layout. Metal film or carbon composition axially-leaded resistors can also provide good performance when their leads are as short as possible. Never use wirewound resistors for high-frequency applications. Remember that most potentiometers have large parasitic capacitances and inductances.

Multilayer ceramic chip capacitors work best and take up little space. Monolithic ceramic capacitors also work very well. Use RF type capacitors with low ESR and ESL. The large power pin bypass capacitors ( $2.2\ \mu\text{F}$  to  $6.8\ \mu\text{F}$ ) should be tantalum for better high-frequency and pulse performance.

- e) **Choose low resistor values** to minimize the time constant set by the resistor and its parasitic parallel capacitance. Good metal film or surface mount resistors have approximately  $0.2\ \text{pF}$  parasitic parallel capacitance. For resistors  $> 1.5\ \text{k}\Omega$ , this adds a pole and/or zero below  $500\ \text{MHz}$ .

Make sure that the output loading is not too heavy. The recommended  $402\text{-}\Omega$  feedback resistor is a good starting point in your design.

- f) **Use short direct traces to other wideband devices** on the board. Short traces act as a lumped capacitive load. Wide traces ( $50$  to  $100$  mils) should be used. Estimate the total capacitive load at the output, and use the series isolation resistor recommended in the typical performance curve " $R_S$  vs Capacitive Load". Parasitic loads  $< 2\ \text{pF}$  may not need the isolation resistor.



POST OFFICE BOX 655303 • DALLAS, TEXAS 75265



g) **When long traces are necessary**, use transmission line design techniques (consult an ECL design handbook for microstrip and stripline layout techniques). A 50- $\Omega$  transmission line is not required on board—a higher characteristic impedance will help reduce output loading. Use a matching series resistor at the output of the op amp to drive a transmission line, and a matched load resistor at the other end to make the line appear as a resistor. If the 6 dB of attenuation that the matched load produces is not acceptable, and the line is not too long, use the series resistor at the source only. This will isolate the source from the reactive load presented by the line, but the frequency response will be degraded.

Multiple destination devices are best handled as separate transmission lines, each with its own series source and shunt load terminations. Any parasitic impedances acting on the terminating resistors will alter the transmission line match, and can cause unwanted signal reflections and reactive loading.

h) **Do not use sockets** for high-speed parts like the OPA688. The additional lead length and pin-to-pin capacitance introduced by the socket creates an extremely troublesome parasitic network. Best results are obtained by soldering the part onto the board.

### power supplies

The OPA688 is nominally specified for operation using either  $\pm 5$ -V supplies or a single +5-V supply. The maximum specified total supply voltage of 12 V allows reasonable tolerances on the supplies. Higher supply voltages can break down internal junctions, possibly leading to catastrophic failure. Single-supply operation is possible as long as common mode voltage constraints are observed. The common mode input and output voltage specifications can be interpreted as a required headroom to the supply voltage. Observing this input and output headroom requirement will allow design of non-standard or single-supply operation circuits. Figure 31 shows one approach to single-supply operation.

### ESD protection

ESD damage has been known to damage MOSFET devices, but any semiconductor device is vulnerable to ESD damage. This is particularly true for very high-speed, fine geometry processes.

ESD damage can cause subtle changes in amplifier input characteristics without necessarily destroying the device. In precision operational amplifiers, this may cause a noticeable degradation of offset voltage and drift. Therefore, ESD handling precautions are required when handling the OPA688.

### output limiters

The output voltage is linearly dependent on the input(s) when it is between the limiter voltages  $V_H$  (pin 8) and  $V_L$  (pin 5). When the output tries to exceed  $V_H$  or  $V_L$ , the corresponding limiter buffer takes control of the output voltage and holds it at  $V_H$  or  $V_L$ .

Because the limiters act on the output, their accuracy does not change with gain. The transition from the linear region of operation to output limiting is very sharp—the desired output signal can safely come to within 30 mV of  $V_H$  or  $V_L$  with no onset of non-linearity.

The limiter voltages can be set to within 0.7 V of the supplies ( $V_L \geq -V_S + 0.7$  V,  $V_H \leq +V_S - 0.7$  V). They must also be at least 400 mV apart ( $V_H - V_L \geq 0.4$  V).

# OPA688M UNITY-GAIN-STABLE WIDEBAND VOLTAGE LIMITING AMPLIFIER

SGLS144B – APRIL 2003 – DECEMBER 2006

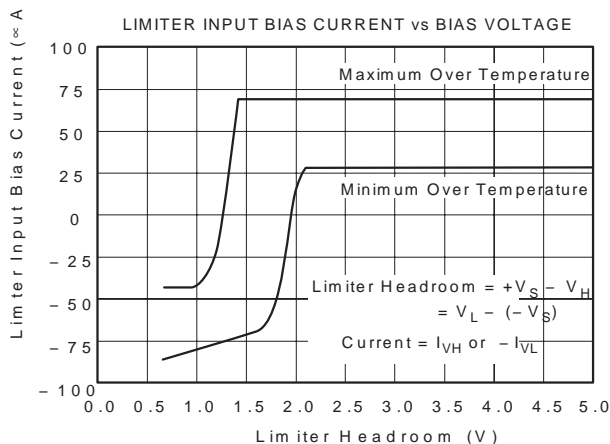

**Figure 37. Limiter Bias Current vs Bias Voltage**

When pins 5 and 8 are left open,  $V_H$  and  $V_L$  go to the Default Voltage Limit; the minimum values are in the Specifications. Looking at Figure 37 for the zero bias current case will show the expected range of  $(V_S - \text{default limit voltages}) = \text{headroom}$ .

When the limiter voltages are more than 2.1V from the supplies ( $V_L > -V_S + 2.1 \text{ V}$  or  $V_H < +V_S - 2.1 \text{ V}$ ), you can use simple resistor dividers to set  $V_H$  and  $V_L$  (see Figure 30). Make sure you include the Limiter Input Bias Currents (Figure 37) in the calculations (i.e.,  $I_{V_L} \geq -50 \mu\text{A}$  out of pin 5, and  $I_{V_H} \leq +50 \mu\text{A}$  out of pin 8). For good limiter voltage accuracy, run at least 1-mA quiescent bias current through these resistors.

When the limiter voltages need to be within 2.1V of the supplies ( $V_L \leq -V_S + 2.1 \text{ V}$  or  $V_H \geq +V_S - 2.1 \text{ V}$ ), consider using low impedance buffers to set  $V_H$  and  $V_L$  to minimize errors due to bias current uncertainty. This will typically be the case for single supply operation ( $V_S = +5\text{V}$ ). Figure 31 runs 2.5 mA through the resistive divider that sets  $V_H$  and  $V_L$ . This keeps errors due to  $I_{V_H}$  and  $I_{V_L} < \pm 1\%$  of the target limit voltages.

The limiters' DC accuracy depends on attention to detail. The two dominant error sources can be improved as follows:

- Power supplies, when used to drive resistive dividers that set  $V_H$  and  $V_L$ , can contribute large errors (e.g.,  $\pm 5\%$ ). Using a more accurate source, and bypassing pins 5 and 8 with good capacitors, will improve limiter PSRR.
- The resistor tolerances in the resistive divider can also dominate. Use 1% resistors.

Other error sources also contribute, but should have little impact on the limiters' DC accuracy:

- Reduce offsets caused by the Limiter Input Bias Currents. Select the resistors in the resistive divider(s) as described above.
- Consider the signal path DC errors as contributing to uncertainty in the useable output swing.
- The Limiter Offset Voltage only slightly degrades limiter accuracy.

Figure 38 shows how the limiters affect distortion performance. Virtually no degradation in linearity is observed for output voltage swinging right up to the limiter voltages.

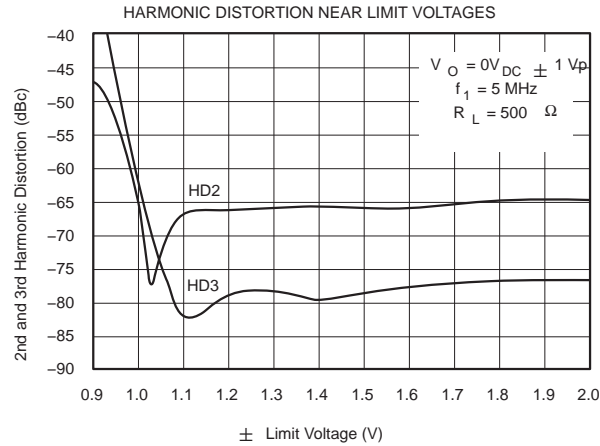

**Figure 38. Harmonic Distortion Near Limit Voltages**

### offset voltage adjustment

The circuit in Figure 39 allows offset adjustment without degrading offset drift with temperature. Use this circuit with caution since power supply noise can inadvertently couple into the op amp.

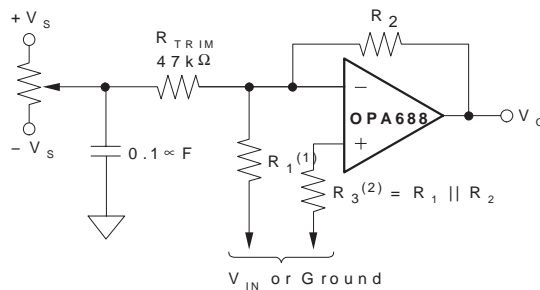

NOTES: (1) Set  $R_1 \ll R_{TRIM}$ . (2)  $R_3$  is optional and minimizes output offset due to input bias currents.

**Figure 39. Offset Voltage Trim**

Remember that additional offset errors can be created by the amplifier's input bias currents. Whenever possible, match the impedance seen by both DC input bias currents using  $R_3$ . This minimizes the output offset voltage caused by the input bias currents.

### output drive

The OPA688 has been optimized to drive 500-Ω loads, such as ADCs. It still performs very well driving 100-Ω loads; the specifications are shown for the 500-Ω load. This makes the OPA688 an ideal choice for a wide range of high-frequency applications.

Many high-speed applications, such as driving ADCs, require op amps with low output impedance. As shown in the typical performance curve "Output Impedance vs Frequency", the OPA688 maintains very low closed-loop output impedance over frequency. Closed-loop output impedance increases with frequency, since loop gain decreases with frequency.

# OPA688M UNITY-GAIN-STABLE WIDEBAND VOLTAGE LIMITING AMPLIFIER

SGLS144B – APRIL 2003 – DECEMBER 2006

## thermal considerations

The OPA688 will not require heat-sinking under most operating conditions. Maximum desired junction temperature will set a maximum allowed internal power dissipation as described below. In no case should the maximum junction temperature be allowed to exceed 150°C.

The total internal power dissipation ( $P_D$ ) is the sum of quiescent power ( $P_{DQ}$ ) and the additional power dissipated in the output stage ( $P_{DL}$ ) while delivering load power.  $P_{DQ}$  is simply the specified no-load supply current times the total supply voltage across the part.  $P_{DL}$  depends on the required output signals and loads. For a grounded resistive load, and equal bipolar supplies, it is at a maximum when the output is at 1/2 either supply voltage. In this condition,  $P_{DL} = V_S^2/(4R_L)$  where  $R_L$  includes the feedback network loading. Note that it is the power in the output stage, and not in the load, that comprises  $P_{DL}$ .

The operating junction temperature is:  $T_J = T_A + P_D \Theta_{JA}$ , where  $T_A$  is the ambient temperature.

For example, the maximum  $T_J$  for a OPA688M with  $G = +2$ ,  $R_{FB} = 402 \Omega$ ,  $R_L = 100 \Omega$ , and  $\pm V_S = \pm 5 \text{ V}$  at the maximum  $T_A = + 85^\circ\text{C}$  is calculated as:

$$P_{DQ} = (10 \text{ V} \times 20 \text{ mA}) = 200 \text{ mW}$$

$$P_{DL} = \frac{(5 \text{ V})^2}{4 \times (100 \Omega \parallel 804 \Omega)} = 70 \text{ mW}$$

$$P_D = 200 \text{ mW} + 70 \text{ mW} = 270 \text{ mW}$$

$$T_J = 85^\circ\text{C} + 270 \text{ mW} \times (119^\circ\text{C/W}) = 117^\circ\text{C}$$

## capacitive loads

Capacitive loads, such as the input to ADCs, will decrease the amplifier's phase margin, which may cause high-frequency peaking or oscillations. Capacitive loads  $\times 2 \text{ pF}$  should be isolated by connecting a small resistor in series with the output as shown in Figure 40. Increasing the gain from +2 will improve the capacitive drive capabilities due to increased phase margin.

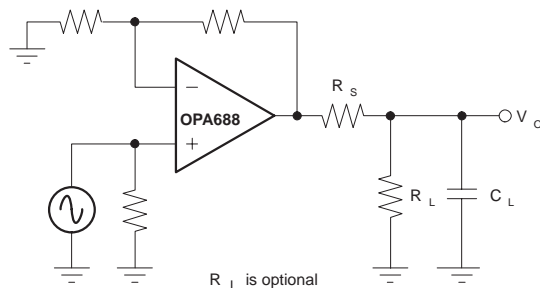

Figure 40. Driving Capacitive Loads

In general, capacitive loads should be minimized for optimum high-frequency performance. The capacitance of coax cable (29 pF/foot for RG-58) will not load the amplifier when the coaxial cable, or transmission line, is terminated in its characteristic impedance.

## frequency response compensation

The OPA688 is internally compensated to be unity-gain stable, and has a nominal phase margin of 60° at a gain of +2. Phase margin and peaking improve at higher gains. Recall that an inverting gain of -1 is equivalent to a gain of +2 for bandwidth purposes (i.e., noise gain = 2).

Standard external compensation techniques work with this device. For example, in the inverting configuration, the bandwidth may be limited without modifying the inverting gain by placing a series RC network to ground on the inverting node. This has the effect of increasing the noise gain at high frequencies, which limits the bandwidth.

To maintain a wide bandwidth at high gains, cascade several op amps, or use the high gain optimized OPA689.

In applications where a large feedback resistor is required, such as photodiode transimpedance amplifier, the parasitic capacitance from the inverting input to ground causes peaking or oscillations. To compensate for this effect, connect a small capacitor in parallel with the feedback resistor. The bandwidth will be limited by the pole that the feedback resistor and this capacitor create. In other high gain applications, use a three resistor "Tee" network to reduce the RC time constants set by the parasitic capacitances. Be careful to not increase the noise generated by this feedback network too much.

## pulse settling time

The OPA688 is capable of an extremely fast settling time in response to a pulse input. Frequency response flatness and phase linearity are needed to obtain the best settling times. For capacitive loads, such as an ADC, use the recommended  $R_S$  in the typical performance curve "R<sub>S</sub> vs Capacitive Load". Extremely fine-scale settling (0.01%) requires close attention to ground return current in the supply decoupling capacitors.

The pulse settling characteristics when recovering from overdrive are very good.

## distortion

The OPA688's distortion performance is specified for a 500-Ω load, such as an ADC. Driving loads with smaller resistance will increase the distortion as illustrated in Figure 41. Remember to include the feedback network in the load resistance calculations.

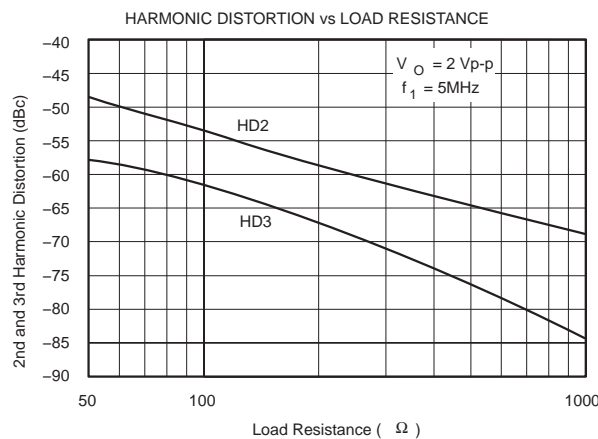

**Figure 41. 5 MHz Harmonic Distortion vs Load Resistance**

**PACKAGING INFORMATION**

Orderable Device	Status <sup>(1)</sup>	Package Type	Package Drawing	Pins	Package Qty	Eco Plan <sup>(2)</sup>	Lead/Ball Finish	MSL Peak Temp <sup>(3)</sup>
OPA688MJD	NRND	CDIP SB	JD	8	1	TBD	POST-PLATE	N / A for Pkg Type

<sup>(1)</sup> The marketing status values are defined as follows:

**ACTIVE:** Product device recommended for new designs.

**LIFEBUY:** TI has announced that the device will be discontinued, and a lifetime-buy period is in effect.

**NRND:** Not recommended for new designs. Device is in production to support existing customers, but TI does not recommend using this part in a new design.

**PREVIEW:** Device has been announced but is not in production. Samples may or may not be available.

**OBSOLETE:** TI has discontinued the production of the device.

<sup>(2)</sup> Eco Plan - The planned eco-friendly classification: Pb-Free (RoHS), Pb-Free (RoHS Exempt), or Green (RoHS & no Sb/Br) - please check <http://www.ti.com/productcontent> for the latest availability information and additional product content details.

**TBD:** The Pb-Free/Green conversion plan has not been defined.

**Pb-Free (RoHS):** TI's terms "Lead-Free" or "Pb-Free" mean semiconductor products that are compatible with the current RoHS requirements for all 6 substances, including the requirement that lead not exceed 0.1% by weight in homogeneous materials. Where designed to be soldered at high temperatures, TI Pb-Free products are suitable for use in specified lead-free processes.

**Pb-Free (RoHS Exempt):** This component has a RoHS exemption for either 1) lead-based flip-chip solder bumps used between the die and package, or 2) lead-based die adhesive used between the die and leadframe. The component is otherwise considered Pb-Free (RoHS compatible) as defined above.

**Green (RoHS & no Sb/Br):** TI defines "Green" to mean Pb-Free (RoHS compatible), and free of Bromine (Br) and Antimony (Sb) based flame retardants (Br or Sb do not exceed 0.1% by weight in homogeneous material)

<sup>(3)</sup> MSL, Peak Temp. -- The Moisture Sensitivity Level rating according to the JEDEC industry standard classifications, and peak solder temperature.

**Important Information and Disclaimer:** The information provided on this page represents TI's knowledge and belief as of the date that it is provided. TI bases its knowledge and belief on information provided by third parties, and makes no representation or warranty as to the accuracy of such information. Efforts are underway to better integrate information from third parties. TI has taken and continues to take reasonable steps to provide representative and accurate information but may not have conducted destructive testing or chemical analysis on incoming materials and chemicals. TI and TI suppliers consider certain information to be proprietary, and thus CAS numbers and other limited information may not be available for release.

In no event shall TI's liability arising out of such information exceed the total purchase price of the TI part(s) at issue in this document sold by TI to Customer on an annual basis.

**OTHER QUALIFIED VERSIONS OF OPA688M :**

- Catalog: [OPA688](#)

NOTE: Qualified Version Definitions:

- Catalog - TI's standard catalog product

## IMPORTANT NOTICE

Texas Instruments Incorporated and its subsidiaries (TI) reserve the right to make corrections, modifications, enhancements, improvements, and other changes to its products and services at any time and to discontinue any product or service without notice. Customers should obtain the latest relevant information before placing orders and should verify that such information is current and complete. All products are sold subject to TI's terms and conditions of sale supplied at the time of order acknowledgment.

TI warrants performance of its hardware products to the specifications applicable at the time of sale in accordance with TI's standard warranty. Testing and other quality control techniques are used to the extent TI deems necessary to support this warranty. Except where mandated by government requirements, testing of all parameters of each product is not necessarily performed.

TI assumes no liability for applications assistance or customer product design. Customers are responsible for their products and applications using TI components. To minimize the risks associated with customer products and applications, customers should provide adequate design and operating safeguards.

TI does not warrant or represent that any license, either express or implied, is granted under any TI patent right, copyright, mask work right, or other TI intellectual property right relating to any combination, machine, or process in which TI products or services are used. Information published by TI regarding third-party products or services does not constitute a license from TI to use such products or services or a warranty or endorsement thereof. Use of such information may require a license from a third party under the patents or other intellectual property of the third party, or a license from TI under the patents or other intellectual property of TI.

Reproduction of TI information in TI data books or data sheets is permissible only if reproduction is without alteration and is accompanied by all associated warranties, conditions, limitations, and notices. Reproduction of this information with alteration is an unfair and deceptive business practice. TI is not responsible or liable for such altered documentation. Information of third parties may be subject to additional restrictions.

Resale of TI products or services with statements different from or beyond the parameters stated by TI for that product or service voids all express and any implied warranties for the associated TI product or service and is an unfair and deceptive business practice. TI is not responsible or liable for any such statements.

TI products are not authorized for use in safety-critical applications (such as life support) where a failure of the TI product would reasonably be expected to cause severe personal injury or death, unless officers of the parties have executed an agreement specifically governing such use. Buyers represent that they have all necessary expertise in the safety and regulatory ramifications of their applications, and acknowledge and agree that they are solely responsible for all legal, regulatory and safety-related requirements concerning their products and any use of TI products in such safety-critical applications, notwithstanding any applications-related information or support that may be provided by TI. Further, Buyers must fully indemnify TI and its representatives against any damages arising out of the use of TI products in such safety-critical applications.

TI products are neither designed nor intended for use in military/aerospace applications or environments unless the TI products are specifically designated by TI as military-grade or "enhanced plastic." Only products designated by TI as military-grade meet military specifications. Buyers acknowledge and agree that any such use of TI products which TI has not designated as military-grade is solely at the Buyer's risk, and that they are solely responsible for compliance with all legal and regulatory requirements in connection with such use.

TI products are neither designed nor intended for use in automotive applications or environments unless the specific TI products are designated by TI as compliant with ISO/TS 16949 requirements. Buyers acknowledge and agree that, if they use any non-designated products in automotive applications, TI will not be responsible for any failure to meet such requirements.

Following are URLs where you can obtain information on other Texas Instruments products and application solutions:

### Products

Amplifiers	<a href="http://amplifier.ti.com">amplifier.ti.com</a>
Data Converters	<a href="http://dataconverter.ti.com">dataconverter.ti.com</a>
DLP® Products	<a href="http://www.dlp.com">www.dlp.com</a>
DSP	<a href="http://dsp.ti.com">dsp.ti.com</a>
Clocks and Timers	<a href="http://www.ti.com/clocks">www.ti.com/clocks</a>
Interface	<a href="http://interface.ti.com">interface.ti.com</a>
Logic	<a href="http://logic.ti.com">logic.ti.com</a>
Power Mgmt	<a href="http://power.ti.com">power.ti.com</a>
Microcontrollers	<a href="http://microcontroller.ti.com">microcontroller.ti.com</a>
RFID	<a href="http://www.ti-rfid.com">www.ti-rfid.com</a>
RF/IF and ZigBee® Solutions	<a href="http://www.ti.com/lprf">www.ti.com/lprf</a>

### Applications

Audio	<a href="http://www.ti.com/audio">www.ti.com/audio</a>
Automotive	<a href="http://www.ti.com/automotive">www.ti.com/automotive</a>
Broadband	<a href="http://www.ti.com/broadband">www.ti.com/broadband</a>
Digital Control	<a href="http://www.ti.com/digitalcontrol">www.ti.com/digitalcontrol</a>
Medical	<a href="http://www.ti.com/medical">www.ti.com/medical</a>
Military	<a href="http://www.ti.com/military">www.ti.com/military</a>
Optical Networking	<a href="http://www.ti.com/opticalnetwork">www.ti.com/opticalnetwork</a>
Security	<a href="http://www.ti.com/security">www.ti.com/security</a>
Telephony	<a href="http://www.ti.com/telephony">www.ti.com/telephony</a>
Video & Imaging	<a href="http://www.ti.com/video">www.ti.com/video</a>
Wireless	<a href="http://www.ti.com/wireless">www.ti.com/wireless</a>

Mailing Address: Texas Instruments, Post Office Box 655303, Dallas, Texas 75265  
Copyright © 2009, Texas Instruments Incorporated