

# 0.1- $\mu\text{V}/^\circ\text{C}$ Drift, Low-Noise, Rail-to-Rail Output, 36-V, Zero-Drift OPERATIONAL AMPLIFIERS

Check for Samples: [OPA2180](#), [OPA4180](#)

## FEATURES

- Low Offset Voltage: 75  $\mu\text{V}$  (max)
- Zero-Drift: 0.1  $\mu\text{V}/^\circ\text{C}$
- Low Noise: 10  $\text{nV}/\sqrt{\text{Hz}}$
- Very Low 1/f Noise
- Excellent DC Precision:
  - PSRR: 126 dB
  - CMRR: 114 dB
  - Open-Loop Gain ( $A_{OL}$ ): 120 dB
- Quiescent Current: 525  $\mu\text{A}$  (max)
- Wide Supply Range:  $\pm 2\text{ V}$  to  $\pm 18\text{ V}$
- Rail-to-Rail Output:  
Input Includes Negative Rail
- Low Bias Current: 250 pA (typ)
- RFI Filtered Inputs
- **MicroSIZE Packages**

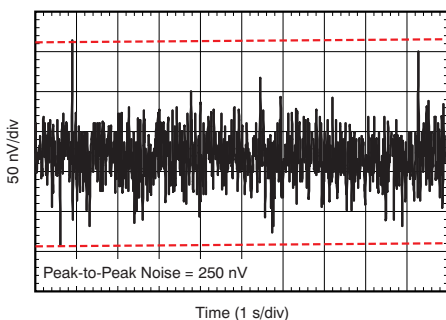

## APPLICATIONS

- Bridge Amplifiers
- Strain Gauges
- Test Equipment
- Transducer Applications
- Temperature Measurement
- Electronic Scales
- Medical Instrumentation
- Resister Thermal Detectors
- Precision Active Filters

## DESCRIPTION

The OPA2180 and OPA4180 operational amplifiers use zero-drift techniques to simultaneously provide low offset voltage (75  $\mu\text{V}$ ), and near zero-drift over time and temperature. These miniature, high-precision, low quiescent current amplifiers offer high input impedance and rail-to-rail output swing within 18 mV of the rails. The input common-mode range includes the negative rail. Either single or dual supplies can be used in the range of +4.0 V to +36 V ( $\pm 2\text{ V}$  to  $\pm 18\text{ V}$ ).

The dual version is offered in MSOP-8 and SO-8 packages. The quad is offered in SO-14 and TSSOP-14 packages. All versions are specified for operation from  $-40^\circ\text{C}$  to  $+105^\circ\text{C}$ .

## Zero-Drift Amplifier Portfolio

VERSION	PRODUCT	OFFSET VOLTAGE ( $\mu\text{V}$ )	OFFSET VOLTAGE DRIFT ( $\mu\text{V}/^\circ\text{C}$ )	BANDWIDTH (MHz)
Single	<a href="#">OPA188</a> (4 V to 36 V)	25	0.085	2
	<a href="#">OPA333</a> (5 V)	10	0.05	0.35
	<a href="#">OPA378</a> (5 V)	50	0.25	0.9
	<a href="#">OPA735</a> (12 V)	5	0.05	1.6
Dual	<a href="#">OPA2188</a> (4 V to 36 V)	25	0.085	2
	<a href="#">OPA2180</a> (4 V to 36 V)	75	0.35	2
	<a href="#">OPA2333</a> (5 V)	10	0.05	0.35
	<a href="#">OPA2378</a> (5 V)	50	0.25	0.9
	<a href="#">OPA2735</a> (12 V)	5	0.05	1.6
Quad	<a href="#">OPA4188</a> (4 V to 36 V)	25	0.085	2
	<a href="#">OPA4180</a> (4 V to 36 V)	75	0.35	2
	<a href="#">OPA4330</a> (5 V)	50	0.25	0.35



Please be aware that an important notice concerning availability, standard warranty, and use in critical applications of Texas Instruments semiconductor products and disclaimers thereto appears at the end of this data sheet.

All trademarks are the property of their respective owners.



This integrated circuit can be damaged by ESD. Texas Instruments recommends that all integrated circuits be handled with appropriate precautions. Failure to observe proper handling and installation procedures can cause damage.

ESD damage can range from subtle performance degradation to complete device failure. Precision integrated circuits may be more susceptible to damage because very small parametric changes could cause the device not to meet its published specifications.

**PACKAGE INFORMATION<sup>(1)</sup>**

	PACKAGE-LEAD	PACKAGE DESIGNATOR	SPECIFIED TEMPERATURE RANGE	PACKAGE MARKING
<b>DUAL</b>				
OPA2180	SO-8	D	–40°C to +105°C	2180
	MSOP-8	DGK	–40°C to +105°C	2180
<b>QUAD</b>				
OPA4180	SO-14	D	–40°C to +105°C	OPA4180
	TSSOP-14	PW	–40°C to +105°C	OPA4180

(1) For the most current package and ordering information, see the Package Option Addendum at the end of this document, or visit the device product folder at [www.ti.com](http://www.ti.com).

**ABSOLUTE MAXIMUM RATINGS<sup>(1)</sup>**

		OPA2180, OPA4180	UNIT
Supply voltage		±20, 40 (single supply)	V
Signal input terminals	Voltage	(V–) – 0.5 to (V+) + 0.5	V
	Current	±10	mA
Output short-circuit <sup>(2)</sup>		Continuous	
Operating temperature		–55 to +125	°C
Storage temperature		–65 to +150	°C
Junction temperature		+150	°C
ESD ratings	Human body model (HBM)	1.5	kV
	Charged device model (CDM)	1	kV

(1) Stresses above these ratings may cause permanent damage. Exposure to absolute maximum conditions for extended periods may degrade device reliability. These are stress ratings only and functional operation of the device at these or any other conditions beyond those specified is not implied.

(2) Short-circuit to ground, one amplifier per package.

**ELECTRICAL CHARACTERISTICS:  $V_S = \pm 2\text{ V to } \pm 18\text{ V}$  ( $V_S = +4\text{ V to } +36\text{ V}$ )**

 At  $T_A = +25^\circ\text{C}$ ,  $R_L = 10\text{ k}\Omega$  connected to  $V_S/2$ , and  $V_{\text{COM}} = V_{\text{OUT}} = V_S/2$ , unless otherwise noted.

PARAMETER		CONDITIONS	OPA2180, OPA4180			UNIT
			MIN	TYP	MAX	
<b>OFFSET VOLTAGE</b>						
$V_{\text{OS}}$	Input offset voltage			15	75	$\mu\text{V}$
$dV_{\text{OS}}/dT$	Input offset voltage drift	$T_A = -40^\circ\text{C to } +105^\circ\text{C}$		0.1	0.35	$\mu\text{V}/^\circ\text{C}$
PSRR	Power-supply rejection ratio	$V_S = 4\text{ V to } 36\text{ V}$ , $V_{\text{CM}} = V_S/2$		0.1	0.5	$\mu\text{V}/\text{V}$
		$T_A = -40^\circ\text{C to } +105^\circ\text{C}$ , $V_S = 4\text{ V to } 36\text{ V}$ , $V_{\text{CM}} = V_S/2$			0.5	$\mu\text{V}/\text{V}$
	Long-term stability			See note <sup>(1)</sup>		$\mu\text{V}$
	Channel separation, dc			1		$\mu\text{V}/\text{V}$
<b>INPUT BIAS CURRENT</b>						
$I_B$	Input bias current	OPA2180		$\pm 0.25$	$\pm 1$	nA
		OPA2180, $T_A = -40^\circ\text{C to } +105^\circ\text{C}$			$\pm 5$	nA
		OPA4180		$\pm 0.25$	$\pm 1.7$	nA
		OPA4180, $T_A = -40^\circ\text{C to } +105^\circ\text{C}$			$\pm 6$	nA
$I_{\text{OS}}$	Input offset current	OPA2180		$\pm 0.5$	$\pm 2$	nA
		OPA2180, $T_A = -40^\circ\text{C to } +105^\circ\text{C}$			$\pm 2.5$	nA
		OPA4180			$\pm 3.4$	nA
		OPA4180, $T_A = -40^\circ\text{C to } +105^\circ\text{C}$			$\pm 3$	nA
<b>NOISE</b>						
	Input voltage noise	$f = 0.1\text{ Hz to } 10\text{ Hz}$		0.25		$\mu\text{V}_{\text{PP}}$
$e_n$	Input voltage noise density	$f = 1\text{ kHz}$		10		$\text{nV}/\sqrt{\text{Hz}}$
$i_n$	Input current noise density	$f = 1\text{ kHz}$		10		$\text{fA}/\sqrt{\text{Hz}}$
<b>INPUT VOLTAGE RANGE</b>						
$V_{\text{CM}}$	Common-mode voltage range		$V^-$		$(V^+) - 1.5$	V
CMRR	Common-mode rejection ratio	$(V^-) < V_{\text{CM}} < (V^+) - 1.5\text{ V}$	104	114		dB
		$T_A = -40^\circ\text{C to } +105^\circ\text{C}$ , $(V^-) + 0.5\text{ V} < V_{\text{CM}} < (V^+) - 1.5\text{ V}$	100	104		dB
<b>INPUT IMPEDANCE</b>						
	Differential			100/6		$\text{M}\Omega/\text{pF}$
	Common-mode			6/9.5		$10^{12}\ \Omega/\text{pF}$
<b>OPEN-LOOP GAIN</b>						
$A_{\text{OL}}$	Open-loop voltage gain	$(V^-) + 500\text{ mV} < V_O < (V^+) - 500\text{ mV}$ , $R_L = 10\text{ k}\Omega$	110	120		dB
		$T_A = -40^\circ\text{C to } +105^\circ\text{C}$ , $(V^-) + 500\text{ mV} < V_O < (V^+) - 500\text{ mV}$ , $R_L = 10\text{ k}\Omega$	104	114		dB
<b>FREQUENCY RESPONSE</b>						
GBW	Gain-bandwidth product			2		MHz
SR	Slew rate	$G = +1$		0.8		$\text{V}/\mu\text{s}$
	Settling time	0.1%	$V_S = \pm 18\text{ V}$ , $G = 1$ , 10-V step	22		$\mu\text{s}$
		0.01%	$V_S = \pm 18\text{ V}$ , $G = 1$ , 10-V step	30		$\mu\text{s}$
	Overload recovery time	$V_{\text{IN}} \times G = V_S$		1		$\mu\text{s}$
THD+N	Total harmonic distortion + noise	$f = 1\text{ kHz}$ , $G = 1$ , $V_{\text{OUT}} = 1\text{ V}_{\text{RMS}}$		0.0001		%

 (1) 1000-hour life test at  $+125^\circ\text{C}$  demonstrated randomly distributed variation in the range of measurement limits, or approximately  $4\ \mu\text{V}$ .

**ELECTRICAL CHARACTERISTICS:  $V_S = \pm 2\text{ V}$  to  $\pm 18\text{ V}$  ( $V_S = +4\text{ V}$  to  $+36\text{ V}$ ) (continued)**

At  $T_A = +25^\circ\text{C}$ ,  $R_L = 10\text{ k}\Omega$  connected to  $V_S/2$ , and  $V_{COM} = V_{OUT} = V_S/2$ , unless otherwise noted.

PARAMETER	CONDITIONS	OPA2180, OPA4180			UNIT
		MIN	TYP	MAX	
<b>OUTPUT</b>					
Voltage output swing from rail	No load		8	18	mV
	$R_L = 10\text{ k}\Omega$		250	300	mV
	$T_A = -40^\circ\text{C}$ to $+105^\circ\text{C}$ , $R_L = 10\text{ k}\Omega$		325	360	mV
$I_{SC}$	Short-circuit current		$\pm 18$		mA
$R_O$	Open-loop output resistance	$f = 2\text{ MHz}$ , $I_O = 0\text{ mA}$	120		$\Omega$
$C_{LOAD}$	Capacitive load drive		1		nF
<b>POWER SUPPLY</b>					
$V_S$	Operating voltage range		$\pm 2$ (or 4)	$\pm 18$ (or 36)	V
$I_Q$	Quiescent current (per amplifier)		450	525	$\mu\text{A}$
		$T_A = -40^\circ\text{C}$ to $+105^\circ\text{C}$ , $I_O = 0\text{ mA}$		600	$\mu\text{A}$
<b>TEMPERATURE</b>					
	Specified range		-40	+105	$^\circ\text{C}$
	Operating range		-40	+125	$^\circ\text{C}$
	Storage range		-65	+150	$^\circ\text{C}$

**THERMAL INFORMATION: OPA2180**

THERMAL METRIC <sup>(1)</sup>		OPA2180		UNITS
		D (SO)	DGK (MSOP)	
		8 PINS	8 PINS	
$\theta_{JA}$	Junction-to-ambient thermal resistance	111.0	159.3	$^\circ\text{C/W}$
$\theta_{JCTop}$	Junction-to-case (top) thermal resistance	54.9	37.4	
$\theta_{JB}$	Junction-to-board thermal resistance	51.7	48.5	
$\Psi_{JT}$	Junction-to-top characterization parameter	9.3	1.2	
$\Psi_{JB}$	Junction-to-board characterization parameter	51.1	77.1	
$\theta_{JCbott}$	Junction-to-case (bottom) thermal resistance	n/a	n/a	

(1) For more information about traditional and new thermal metrics, see the *IC Package Thermal Metrics* application report, [SPRA953](#).

**THERMAL INFORMATION: OPA4180**

THERMAL METRIC <sup>(1)</sup>		OPA4180		UNITS
		D (SO)	PW (TSSOP)	
		14 PINS	14 PINS	
$\theta_{JA}$	Junction-to-ambient thermal resistance	93.2	106.9	$^\circ\text{C/W}$
$\theta_{JCTop}$	Junction-to-case (top) thermal resistance	51.8	24.4	
$\theta_{JB}$	Junction-to-board thermal resistance	49.4	59.3	
$\Psi_{JT}$	Junction-to-top characterization parameter	13.5	0.6	
$\Psi_{JB}$	Junction-to-board characterization parameter	42.2	54.3	
$\theta_{JCbott}$	Junction-to-case (bottom) thermal resistance	N/A	N/A	

(1) For more information about traditional and new thermal metrics, see the *IC Package Thermal Metrics* application report, [SPRA953](#).

**PIN CONFIGURATIONS**

**OPA2180  
D, DGK PACKAGES (SO-8, MSOP-8)  
(TOP VIEW)**

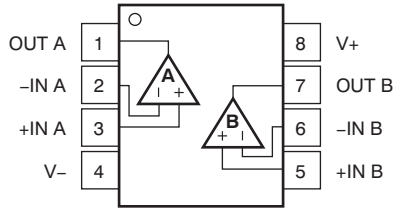

**OPA4180  
D, PW PACKAGES (SO-14, TSSOP-14)  
(TOP VIEW)**

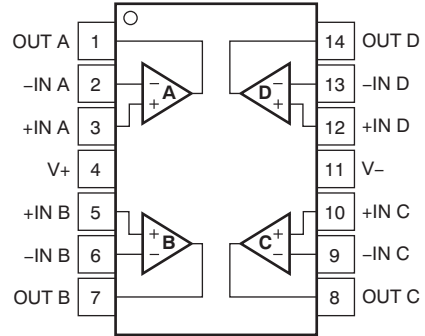

## TYPICAL CHARACTERISTICS

**Table 1. Characteristic Performance Measurements**

DESCRIPTION	FIGURE
$I_B$ and $I_{OS}$ vs Common-Mode Voltage	<a href="#">Figure 1</a>
Input Bias Current vs Temperature	<a href="#">Figure 2</a>
Output Voltage Swing vs Output Current (Maximum Supply)	<a href="#">Figure 3</a>
CMRR vs Temperature	<a href="#">Figure 4</a>
0.1-Hz to 10-Hz Noise	<a href="#">Figure 5</a>
Input Voltage Noise Spectral Density vs Frequency	<a href="#">Figure 6</a>
Open-Loop Gain and Phase vs Frequency	<a href="#">Figure 7</a>
Open-Loop Gain vs Temperature	<a href="#">Figure 8</a>
Open-Loop Output Impedance vs Frequency	<a href="#">Figure 9</a>
Small-Signal Overshoot vs Capacitive Load (100-mV Output Step)	<a href="#">Figure 10</a> , <a href="#">Figure 11</a>
No Phase Reversal	<a href="#">Figure 12</a>
Positive Overload Recovery	<a href="#">Figure 13</a>
Negative Overload Recovery	<a href="#">Figure 14</a>
Small-Signal Step Response (100 mV)	<a href="#">Figure 15</a> , <a href="#">Figure 16</a>
Large-Signal Step Response	<a href="#">Figure 17</a> , <a href="#">Figure 18</a>
Large-Signal Settling Time (10-V Positive Step)	<a href="#">Figure 19</a>
Large-Signal Settling Time (10-V Negative Step)	<a href="#">Figure 20</a>
Short-Circuit Current vs Temperature	<a href="#">Figure 21</a>
Maximum Output Voltage vs Frequency	<a href="#">Figure 22</a>
Channel Separation vs Frequency	<a href="#">Figure 23</a>
EMIRR IN+ vs Frequency	<a href="#">Figure 24</a>

### TYPICAL CHARACTERISTICS

$V_S = \pm 18\text{ V}$ ,  $V_{CM} = V_S/2$ ,  $R_{LOAD} = 10\text{ k}\Omega$  connected to  $V_S/2$ , and  $C_L = 100\text{ pF}$ , unless otherwise noted.

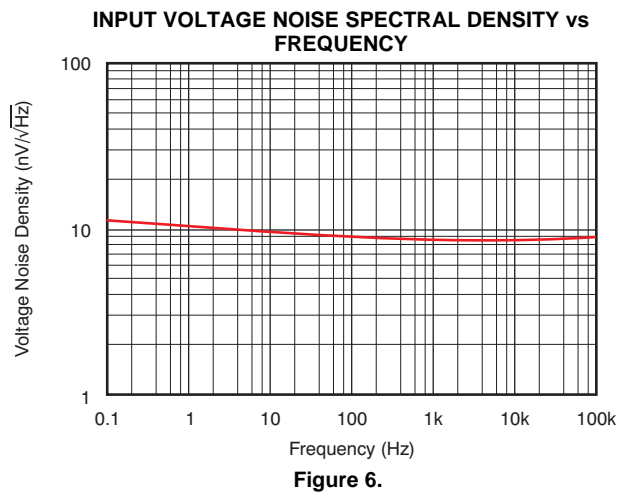
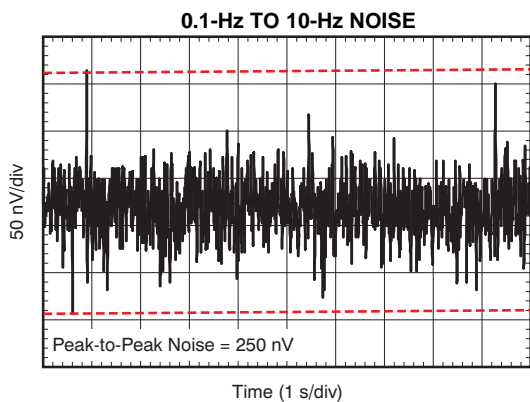
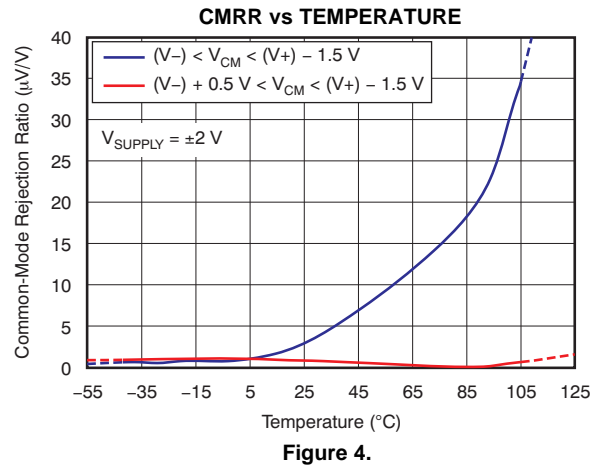
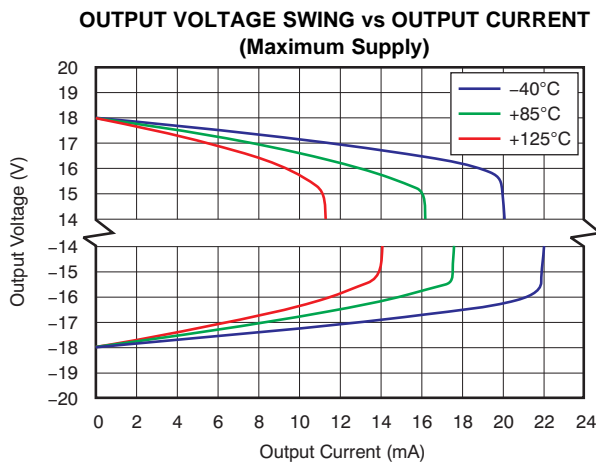
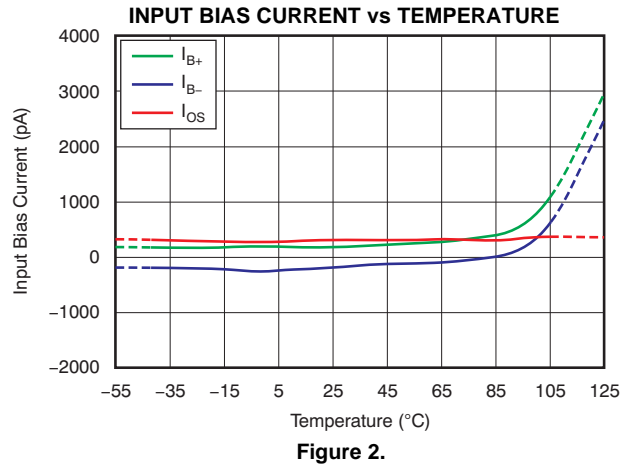
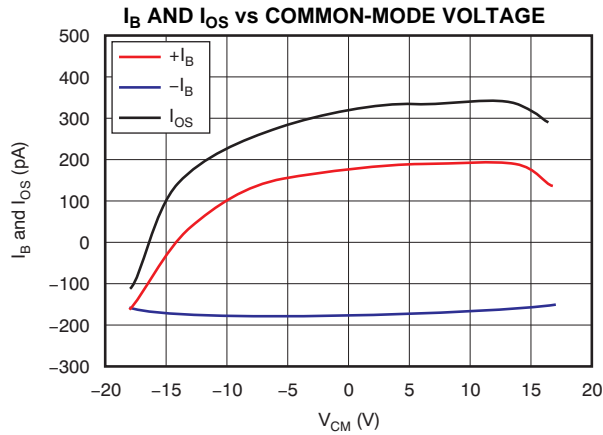

**TYPICAL CHARACTERISTICS (continued)**

$V_S = \pm 18\text{ V}$ ,  $V_{CM} = V_S/2$ ,  $R_{LOAD} = 10\text{ k}\Omega$  connected to  $V_S/2$ , and  $C_L = 100\text{ pF}$ , unless otherwise noted.

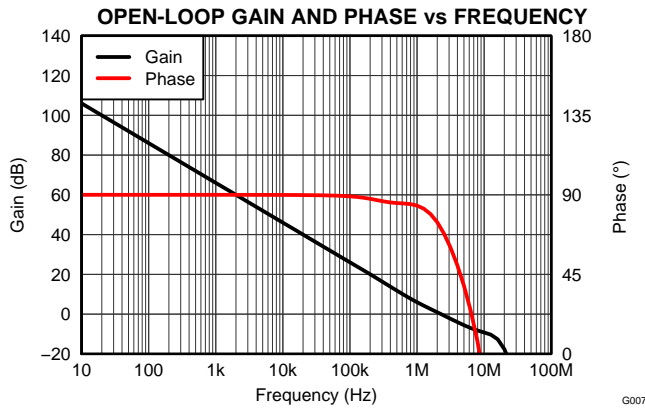

Figure 7.

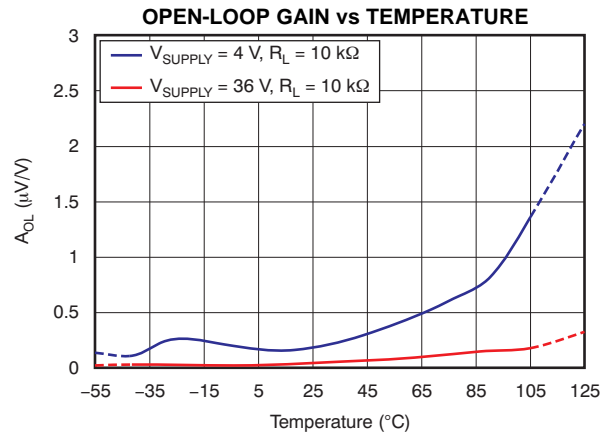

Figure 8.

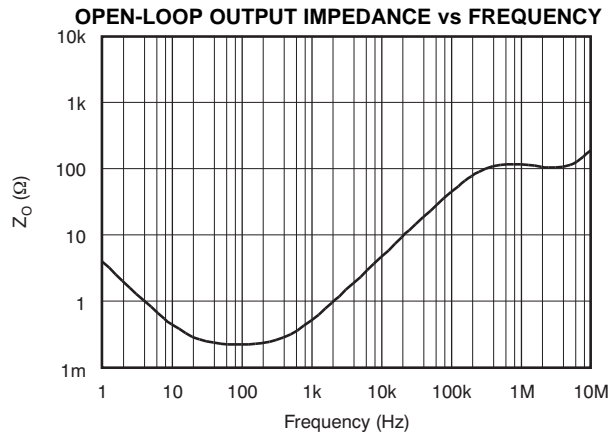

Figure 9.

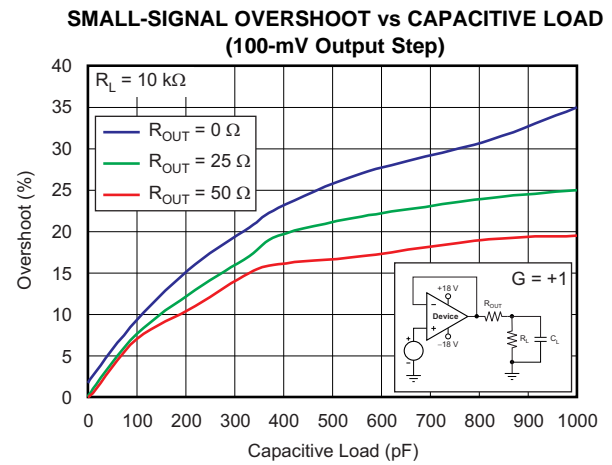

Figure 10.

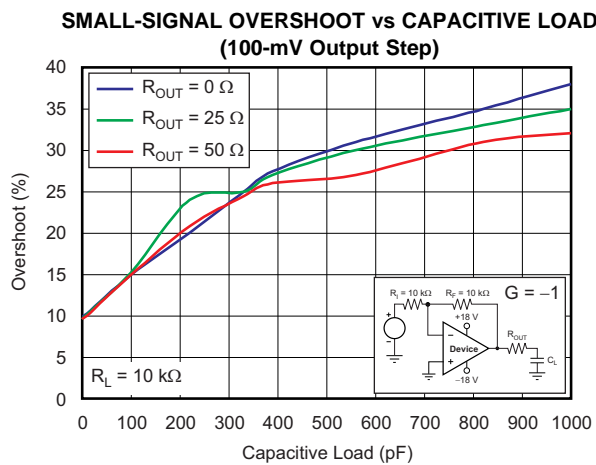

Figure 11.

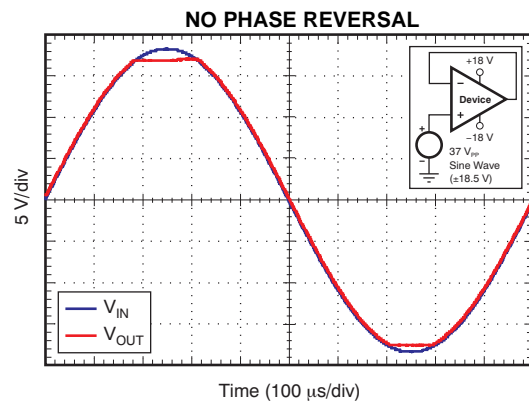

Figure 12.



**TYPICAL CHARACTERISTICS (continued)**

$V_S = \pm 18\text{ V}$ ,  $V_{CM} = V_S/2$ ,  $R_{LOAD} = 10\text{ k}\Omega$  connected to  $V_S/2$ , and  $C_L = 100\text{ pF}$ , unless otherwise noted.

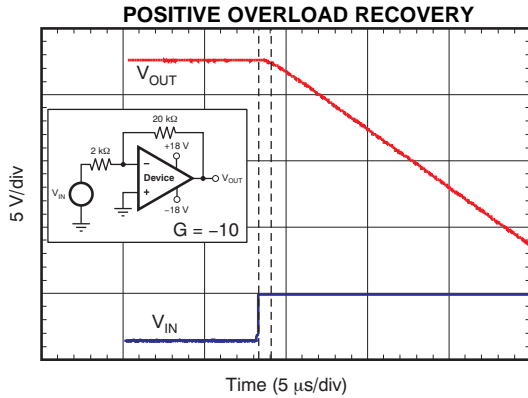

Figure 13.

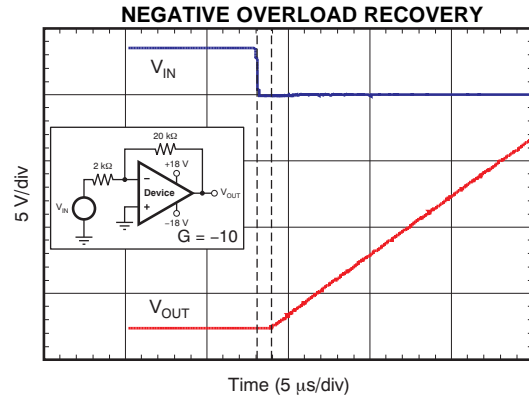

Figure 14.

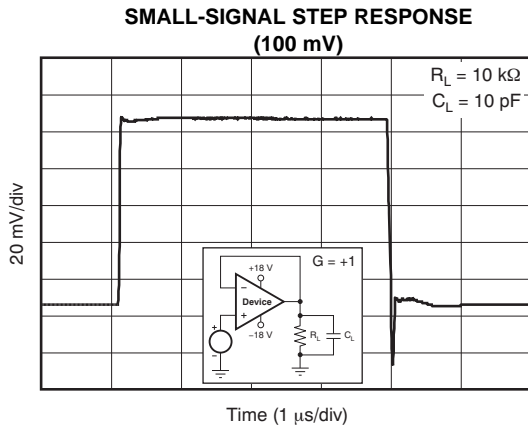

Figure 15.

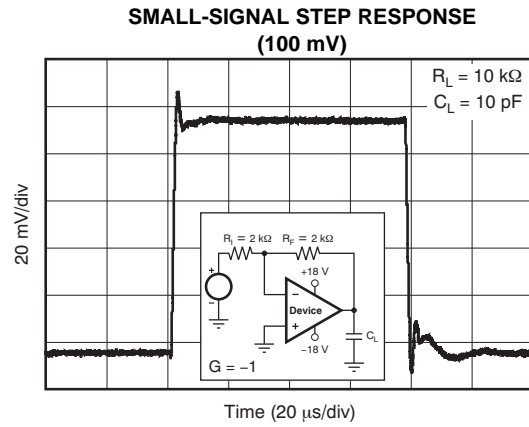

Figure 16.

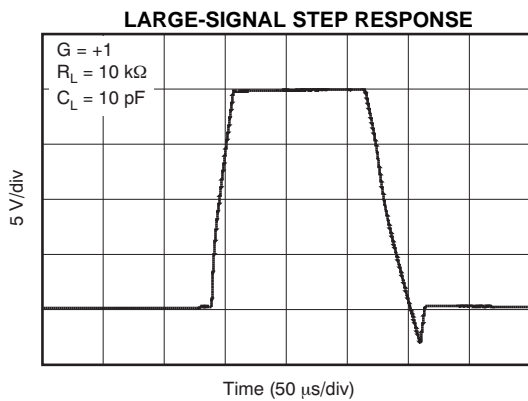

Figure 17.

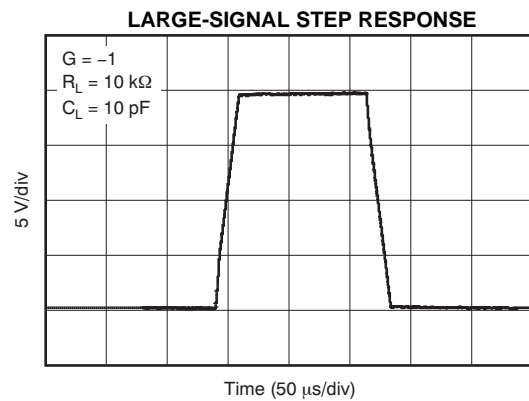
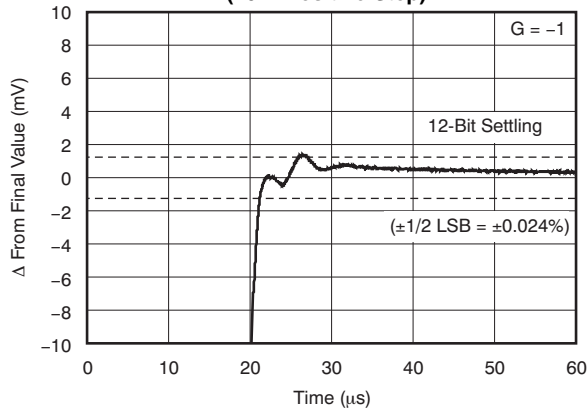

Figure 18.

**TYPICAL CHARACTERISTICS (continued)**

$V_S = \pm 18\text{ V}$ ,  $V_{CM} = V_S/2$ ,  $R_{LOAD} = 10\text{ k}\Omega$  connected to  $V_S/2$ , and  $C_L = 100\text{ pF}$ , unless otherwise noted.

**LARGE-SIGNAL SETTLING TIME  
(10-V Positive Step)**



**Figure 19.**

**LARGE-SIGNAL SETTLING TIME  
(10-V Negative Step)**

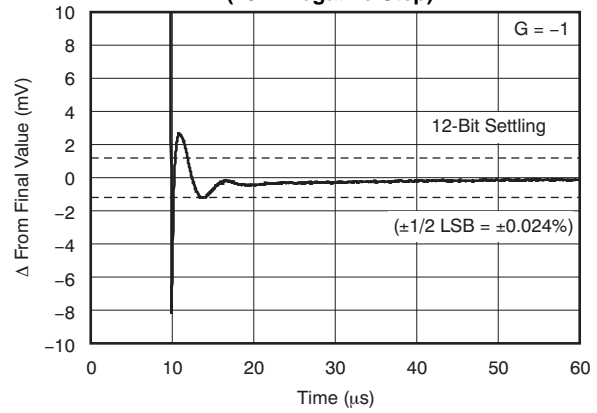

**Figure 20.**

**SHORT-CIRCUIT CURRENT vs TEMPERATURE**

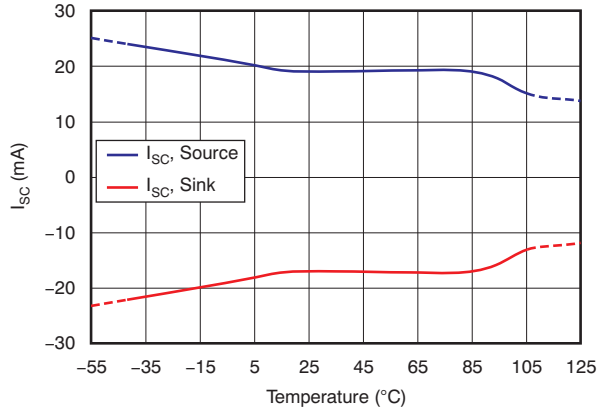

**Figure 21.**

**MAXIMUM OUTPUT VOLTAGE vs FREQUENCY**

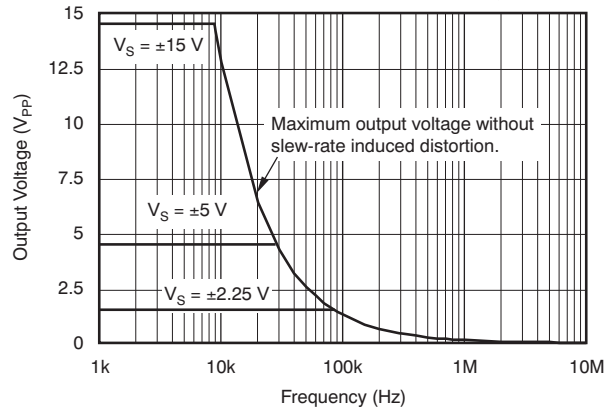

**Figure 22.**

**CHANNEL SEPARATION vs FREQUENCY**

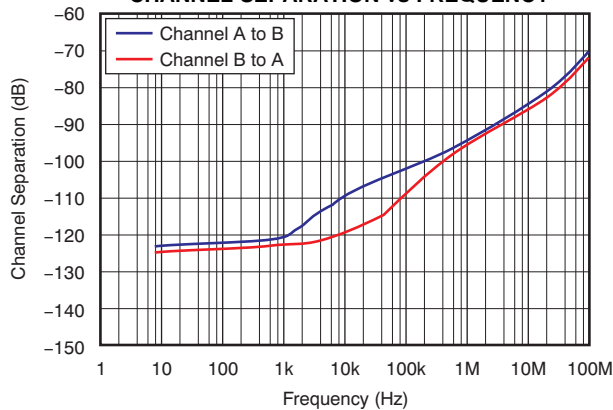

**Figure 23.**

**EMIRR IN+ vs FREQUENCY**

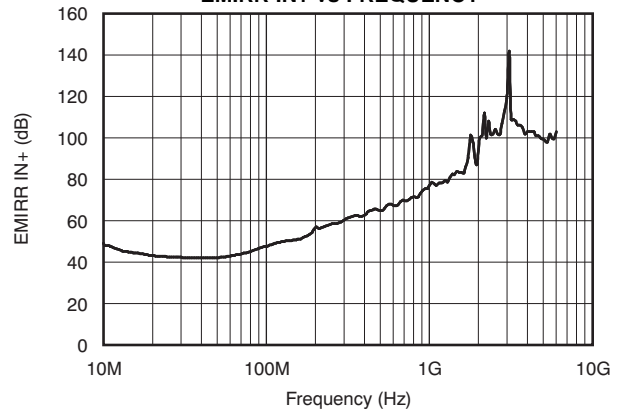

**Figure 24.**

## APPLICATION INFORMATION

The OPAx180 family of operational amplifiers combine precision offset and drift with excellent overall performance, making them ideal for many precision applications. The precision offset drift of only 0.085  $\mu\text{V}/^\circ\text{C}$  provides stability over the entire temperature range. In addition, the device offers excellent overall performance with high CMRR, PSRR, and  $A_{OL}$ . As with all amplifiers, applications with noisy or high-impedance power supplies require decoupling capacitors close to the device pins. In most cases, 0.1- $\mu\text{F}$  capacitors are adequate.

### OPERATING CHARACTERISTICS

The OPAx180 family of amplifiers is specified for operation from 4 V to 36 V ( $\pm 2$  V to  $\pm 18$  V). Many of the specifications apply from  $-40^\circ\text{C}$  to  $+105^\circ\text{C}$ . Parameters that can exhibit significant variance with regard to operating voltage or temperature are presented in the [Typical Characteristics](#).

### EMI REJECTION

The OPAx180 uses integrated electromagnetic interference (EMI) filtering to reduce the effects of EMI interference from sources such as wireless communications and densely populated boards with a mix of analog signal chain and digital components. EMI immunity can be improved with circuit design techniques; the OPAx180 benefits from these design improvements. Texas Instruments has developed the ability to accurately measure and quantify the immunity of an operational amplifier over a broad frequency spectrum extending from 10 MHz to 6 GHz. [Figure 25](#) shows the results of this testing on the OPAx180. Detailed information can also be found in the [Application Report EMI Rejection Ratio of Operational Amplifiers \(SBOA128\)](#), available for download from the TI website.

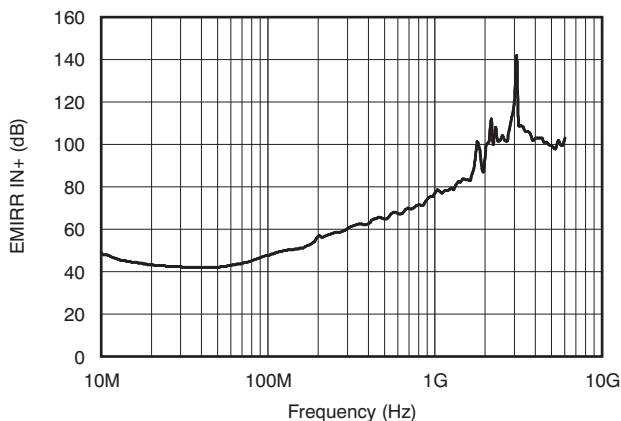

**Figure 25. OPAx180 EMIRR Testing**

## GENERAL LAYOUT GUIDELINES

For best operational performance of the device, good printed circuit board (PCB) layout practices are recommended. Low-loss, 0.1- $\mu\text{F}$  bypass capacitors should be connected between each supply pin and ground, placed as close to the device as possible. A single bypass capacitor from V+ to ground is applicable to single-supply applications.

## PHASE-REVERSAL PROTECTION

The OPAx180 family has an internal phase-reversal protection. Many op amps exhibit a phase reversal when the input is driven beyond its linear common-mode range. This condition is most often encountered in noninverting circuits when the input is driven beyond the specified common-mode voltage range, causing the output to reverse into the opposite rail. The input of the OPAx180 prevents phase reversal with excessive common-mode voltage. Instead, the output limits into the appropriate rail. This performance is shown in Figure 26.

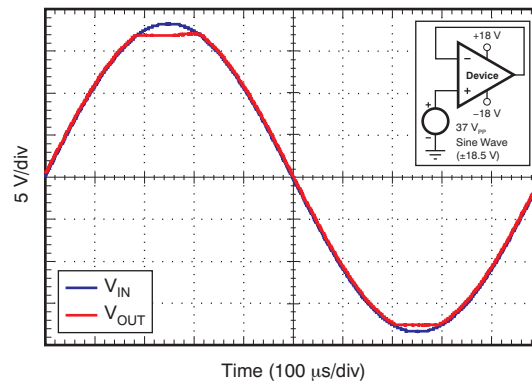

Figure 26. No Phase Reversal

## CAPACITIVE LOAD AND STABILITY

The dynamic characteristics of the OPAx180 have been optimized for a range of common operating conditions. The combination of low closed-loop gain and high capacitive loads decreases the phase margin of the amplifier and can lead to gain peaking or oscillations. As a result, heavier capacitive loads must be isolated from the output. The simplest way to achieve this isolation is to add a small resistor (for example,  $R_{OUT}$  equal to 50  $\Omega$ ) in series with the output. Figure 27 and Figure 28 illustrate graphs of small-signal overshoot versus capacitive load for several values of  $R_{OUT}$ . Also, refer to the [Applications Report, Feedback Plots Define Op Amp AC Performance \(SBOA015\)](#), available for download from the TI website, for details of analysis techniques and application circuits.

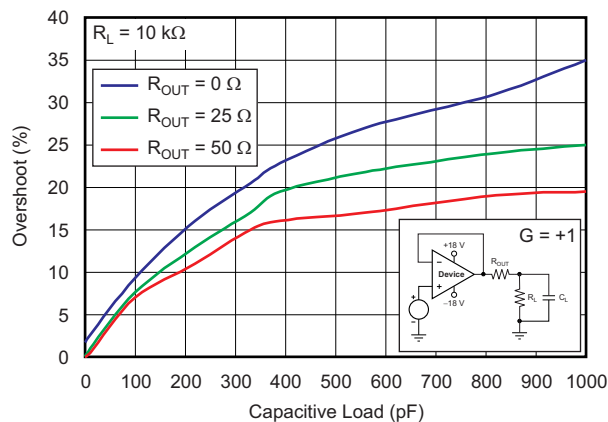

Figure 27. Small-Signal Overshoot versus Capacitive Load (100-mV Output Step)

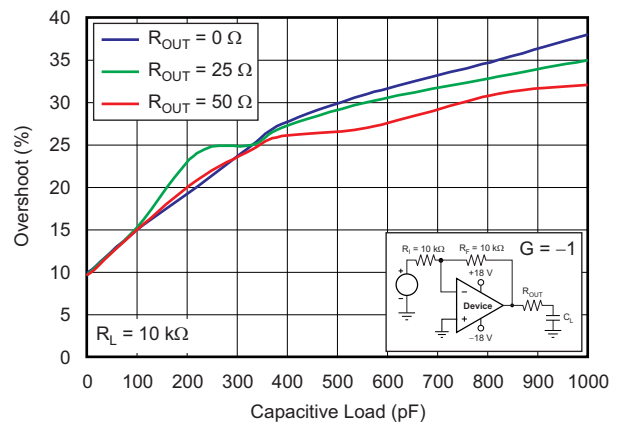
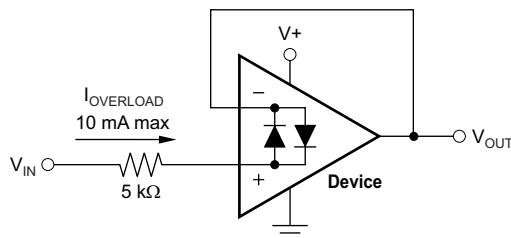

Figure 28. Small-Signal Overshoot versus Capacitive Load (100-mV Output Step)

## ELECTRICAL OVERSTRESS

Designers often ask questions about the capability of an operational amplifier to withstand electrical overstress. These questions tend to focus on the device inputs, but may involve the supply voltage pins or even the output pin. Each of these different pin functions have electrical stress limits determined by the voltage breakdown characteristics of the particular semiconductor fabrication process and specific circuits connected to the pin. Additionally, internal electrostatic discharge (ESD) protection is built into these circuits to protect them from accidental ESD events both before and during product assembly.

These ESD protection diodes also provide in-circuit, input overdrive protection, as long as the current is limited to 10 mA as stated in the [Absolute Maximum Ratings](#). [Figure 29](#) shows how a series input resistor may be added to the driven input to limit the input current. The added resistor contributes thermal noise at the amplifier input and its value should be kept to a minimum in noise-sensitive applications.



**Figure 29. Input Current Protection**

An ESD event produces a short duration, high-voltage pulse that is transformed into a short duration, high-current pulse as it discharges through a semiconductor device. The ESD protection circuits are designed to provide a current path around the operational amplifier core to prevent it from being damaged. The energy absorbed by the protection circuitry is then dissipated as heat.

When the operational amplifier connects into a circuit, the ESD protection components are intended to remain inactive and not become involved in the application circuit operation. However, circumstances may arise where an applied voltage exceeds the operating voltage range of a given pin. Should this condition occur, there is a risk that some of the internal ESD protection circuits may be biased on, and conduct current. Any such current flow occurs through ESD cells and rarely involves the absorption device.

If there is an uncertainty about the ability of the supply to absorb this current, external zener diodes may be added to the supply pins. The zener voltage must be selected such that the diode does not turn on during normal operation.

However, its zener voltage should be low enough so that the zener diode conducts if the supply pin begins to rise above the safe operating supply voltage level.

## APPLICATION EXAMPLES

The application examples of [Figure 30](#) and [Figure 31](#) highlight only a few of the circuits where the OPAx180 family of devices can be used.

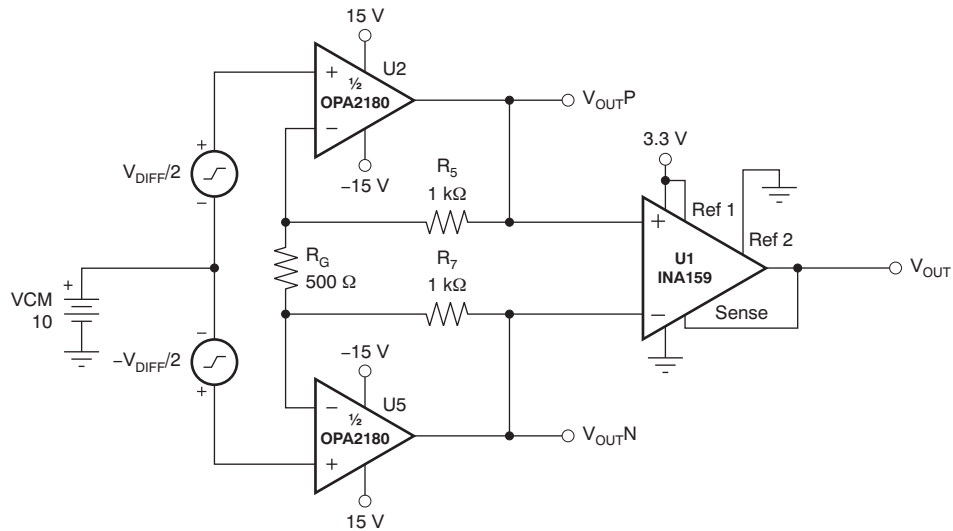

**Figure 30. Discrete INA + Attenuation for ADC with 3.3-V Supply**

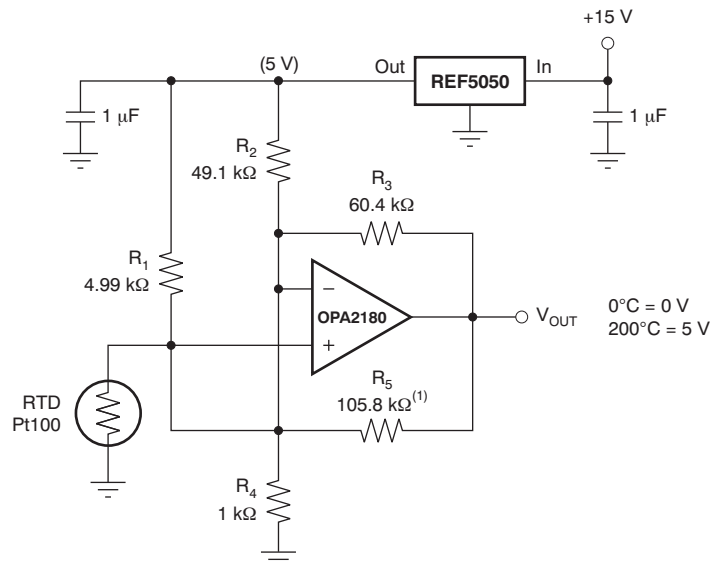

(1)  $R_5$  provides positive-varying excitation to linearize output.

**Figure 31. RTD Amplifier with Linearization**

## REVISION HISTORY

NOTE: Page numbers for previous revisions may differ from page numbers in the current version.

<b>Changes from Revision B (December 2011) to Revision C</b>	<b>Page</b>
• Changed product status from Mixed Status to Production Data .....	1
• Changed OPA4180 status to Production Data .....	1
• Added package marking to OPS2180 MSOP-8 row in Package Information table .....	2
• Deleted ordering number and transport media columns from Package Information table .....	2
• Changed Input Bias Current section in Electrical Characteristics ( $V_S = +4\text{ V}$ to $+36\text{ V}$ ) table .....	3

<b>Changes from Revision A (November 2011) to Revision B</b>	<b>Page</b>
• Changed footnote 1 of Electrical Characteristics table .....	3
• Updated <a href="#">Figure 7</a> .....	7

**PACKAGING INFORMATION**

Orderable Device	Status (1)	Package Type	Package Drawing	Pins	Package Qty	Eco Plan (2)	Lead/Ball Finish	MSL Peak Temp (3)	Samples (Requires Login)
OPA2180ID	ACTIVE	SOIC	D	8	75	Green (RoHS & no Sb/Br)	CU NIPDAU	Level-2-260C-1 YEAR	
OPA2180IDGK	ACTIVE	VSSOP	DGK	8	80	Green (RoHS & no Sb/Br)	CU NIPDAUAG	Level-2-260C-1 YEAR	
OPA2180IDGKR	ACTIVE	VSSOP	DGK	8	2500	Green (RoHS & no Sb/Br)	CU NIPDAUAG	Level-2-260C-1 YEAR	
OPA2180IDR	ACTIVE	SOIC	D	8	2500	Green (RoHS & no Sb/Br)	CU NIPDAU	Level-2-260C-1 YEAR	
OPA4180ID	PREVIEW	SOIC	D	14	50	Green (RoHS & no Sb/Br)	CU NIPDAU	Level-2-260C-1 YEAR	
OPA4180IDR	PREVIEW	SOIC	D	14	2500	Green (RoHS & no Sb/Br)	CU NIPDAU	Level-2-260C-1 YEAR	
OPA4180IPW	PREVIEW	TSSOP	PW	14	90	Green (RoHS & no Sb/Br)	Call TI	Level-2-260C-1 YEAR	
OPA4180IPWR	PREVIEW	TSSOP	PW	14	2000	Green (RoHS & no Sb/Br)	Call TI	Level-2-260C-1 YEAR	

(1) The marketing status values are defined as follows:

**ACTIVE:** Product device recommended for new designs.

**LIFEBUY:** TI has announced that the device will be discontinued, and a lifetime-buy period is in effect.

**NRND:** Not recommended for new designs. Device is in production to support existing customers, but TI does not recommend using this part in a new design.

**PREVIEW:** Device has been announced but is not in production. Samples may or may not be available.

**OBSELETE:** TI has discontinued the production of the device.

(2) Eco Plan - The planned eco-friendly classification: Pb-Free (RoHS), Pb-Free (RoHS Exempt), or Green (RoHS & no Sb/Br) - please check <http://www.ti.com/productcontent> for the latest availability information and additional product content details.

**TBD:** The Pb-Free/Green conversion plan has not been defined.

**Pb-Free (RoHS):** TI's terms "Lead-Free" or "Pb-Free" mean semiconductor products that are compatible with the current RoHS requirements for all 6 substances, including the requirement that lead not exceed 0.1% by weight in homogeneous materials. Where designed to be soldered at high temperatures, TI Pb-Free products are suitable for use in specified lead-free processes.

**Pb-Free (RoHS Exempt):** This component has a RoHS exemption for either 1) lead-based flip-chip solder bumps used between the die and package, or 2) lead-based die adhesive used between the die and leadframe. The component is otherwise considered Pb-Free (RoHS compatible) as defined above.

**Green (RoHS & no Sb/Br):** TI defines "Green" to mean Pb-Free (RoHS compatible), and free of Bromine (Br) and Antimony (Sb) based flame retardants (Br or Sb do not exceed 0.1% by weight in homogeneous material)

(3) MSL, Peak Temp. -- The Moisture Sensitivity Level rating according to the JEDEC industry standard classifications, and peak solder temperature.



**Important Information and Disclaimer:** The information provided on this page represents TI's knowledge and belief as of the date that it is provided. TI bases its knowledge and belief on information provided by third parties, and makes no representation or warranty as to the accuracy of such information. Efforts are underway to better integrate information from third parties. TI has taken and continues to take reasonable steps to provide representative and accurate information but may not have conducted destructive testing or chemical analysis on incoming materials and chemicals. TI and TI suppliers consider certain information to be proprietary, and thus CAS numbers and other limited information may not be available for release.

In no event shall TI's liability arising out of such information exceed the total purchase price of the TI part(s) at issue in this document sold by TI to Customer on an annual basis.

## TAPE AND REEL INFORMATION



### QUADRANT ASSIGNMENTS FOR PIN 1 ORIENTATION IN TAPE



\*All dimensions are nominal

Device	Package Type	Package Drawing	Pins	SPQ	Reel Diameter (mm)	Reel Width W1 (mm)	A0 (mm)	B0 (mm)	K0 (mm)	P1 (mm)	W (mm)	Pin1 Quadrant
OPA2180IDGKR	VSSOP	DGK	8	2500	330.0	12.4	5.3	3.4	1.4	8.0	12.0	Q1
OPA2180IDR	SOIC	D	8	2500	330.0	12.4	6.4	5.2	2.1	8.0	12.0	Q1

**TAPE AND REEL BOX DIMENSIONS**

\*All dimensions are nominal

Device	Package Type	Package Drawing	Pins	SPQ	Length (mm)	Width (mm)	Height (mm)
OPA2180IDGKR	VSSOP	DGK	8	2500	366.0	364.0	50.0
OPA2180IDR	SOIC	D	8	2500	367.0	367.0	35.0

DGK (S-PDSO-G8)

PLASTIC SMALL-OUTLINE PACKAGE



- NOTES:
- A. All linear dimensions are in millimeters.
  - B. This drawing is subject to change without notice.
  - C. Body length does not include mold flash, protrusions, or gate burrs. Mold flash, protrusions, or gate burrs shall not exceed 0.15 per end.
  - D. Body width does not include interlead flash. Interlead flash shall not exceed 0.50 per side.
  - E. Falls within JEDEC MO-187 variation AA, except interlead flash.

D (R-PDSO-G14)

PLASTIC SMALL OUTLINE



4040047-5/M 06/11

- NOTES:
- A. All linear dimensions are in inches (millimeters).
  - B. This drawing is subject to change without notice.
  -  Body length does not include mold flash, protrusions, or gate burrs. Mold flash, protrusions, or gate burrs shall not exceed 0.006 (0,15) each side.
  -  Body width does not include interlead flash. Interlead flash shall not exceed 0.017 (0,43) each side.
  - E. Reference JEDEC MS-012 variation AB.

PW (R-PDSO-G14)

PLASTIC SMALL OUTLINE



4040064-3/G 02/11

- NOTES:
- A. All linear dimensions are in millimeters. Dimensioning and tolerancing per ASME Y14.5M-1994.
  - B. This drawing is subject to change without notice.
  - C. Body length does not include mold flash, protrusions, or gate burrs. Mold flash, protrusions, or gate burrs shall not exceed 0,15 each side.
  - D. Body width does not include interlead flash. Interlead flash shall not exceed 0,25 each side.
  - E. Falls within JEDEC MO-153

D (R-PDSO-G8)

PLASTIC SMALL OUTLINE



- NOTES:
- A. All linear dimensions are in inches (millimeters).
  - B. This drawing is subject to change without notice.
  - Body length does not include mold flash, protrusions, or gate burrs. Mold flash, protrusions, or gate burrs shall not exceed 0.006 (0,15) each side.
  - Body width does not include interlead flash. Interlead flash shall not exceed 0.017 (0,43) each side.
  - E. Reference JEDEC MS-012 variation AA.

D (R-PDSO-G8)

PLASTIC SMALL OUTLINE



4211283-2/E 08/12

- NOTES:
- A. All linear dimensions are in millimeters.
  - B. This drawing is subject to change without notice.
  - C. Publication IPC-7351 is recommended for alternate designs.
  - D. Laser cutting apertures with trapezoidal walls and also rounding corners will offer better paste release. Customers should contact their board assembly site for stencil design recommendations. Refer to IPC-7525 for other stencil recommendations.
  - E. Customers should contact their board fabrication site for solder mask tolerances between and around signal pads.



## IMPORTANT NOTICE

Texas Instruments Incorporated and its subsidiaries (TI) reserve the right to make corrections, enhancements, improvements and other changes to its semiconductor products and services per JESD46, latest issue, and to discontinue any product or service per JESD48, latest issue. Buyers should obtain the latest relevant information before placing orders and should verify that such information is current and complete. All semiconductor products (also referred to herein as "components") are sold subject to TI's terms and conditions of sale supplied at the time of order acknowledgment.

TI warrants performance of its components to the specifications applicable at the time of sale, in accordance with the warranty in TI's terms and conditions of sale of semiconductor products. Testing and other quality control techniques are used to the extent TI deems necessary to support this warranty. Except where mandated by applicable law, testing of all parameters of each component is not necessarily performed.

TI assumes no liability for applications assistance or the design of Buyers' products. Buyers are responsible for their products and applications using TI components. To minimize the risks associated with Buyers' products and applications, Buyers should provide adequate design and operating safeguards.

TI does not warrant or represent that any license, either express or implied, is granted under any patent right, copyright, mask work right, or other intellectual property right relating to any combination, machine, or process in which TI components or services are used. Information published by TI regarding third-party products or services does not constitute a license to use such products or services or a warranty or endorsement thereof. Use of such information may require a license from a third party under the patents or other intellectual property of the third party, or a license from TI under the patents or other intellectual property of TI.

Reproduction of significant portions of TI information in TI data books or data sheets is permissible only if reproduction is without alteration and is accompanied by all associated warranties, conditions, limitations, and notices. TI is not responsible or liable for such altered documentation. Information of third parties may be subject to additional restrictions.

Resale of TI components or services with statements different from or beyond the parameters stated by TI for that component or service voids all express and any implied warranties for the associated TI component or service and is an unfair and deceptive business practice. TI is not responsible or liable for any such statements.

Buyer acknowledges and agrees that it is solely responsible for compliance with all legal, regulatory and safety-related requirements concerning its products, and any use of TI components in its applications, notwithstanding any applications-related information or support that may be provided by TI. Buyer represents and agrees that it has all the necessary expertise to create and implement safeguards which anticipate dangerous consequences of failures, monitor failures and their consequences, lessen the likelihood of failures that might cause harm and take appropriate remedial actions. Buyer will fully indemnify TI and its representatives against any damages arising out of the use of any TI components in safety-critical applications.

In some cases, TI components may be promoted specifically to facilitate safety-related applications. With such components, TI's goal is to help enable customers to design and create their own end-product solutions that meet applicable functional safety standards and requirements. Nonetheless, such components are subject to these terms.

No TI components are authorized for use in FDA Class III (or similar life-critical medical equipment) unless authorized officers of the parties have executed a special agreement specifically governing such use.

Only those TI components which TI has specifically designated as military grade or "enhanced plastic" are designed and intended for use in military/aerospace applications or environments. Buyer acknowledges and agrees that any military or aerospace use of TI components which have **not** been so designated is solely at the Buyer's risk, and that Buyer is solely responsible for compliance with all legal and regulatory requirements in connection with such use.

TI has specifically designated certain components as meeting ISO/TS16949 requirements, mainly for automotive use. In any case of use of non-designated products, TI will not be responsible for any failure to meet ISO/TS16949.

### Products

Audio	<a href="http://www.ti.com/audio">www.ti.com/audio</a>
Amplifiers	<a href="http://amplifier.ti.com">amplifier.ti.com</a>
Data Converters	<a href="http://dataconverter.ti.com">dataconverter.ti.com</a>
DLP® Products	<a href="http://www.dlp.com">www.dlp.com</a>
DSP	<a href="http://dsp.ti.com">dsp.ti.com</a>
Clocks and Timers	<a href="http://www.ti.com/clocks">www.ti.com/clocks</a>
Interface	<a href="http://interface.ti.com">interface.ti.com</a>
Logic	<a href="http://logic.ti.com">logic.ti.com</a>
Power Mgmt	<a href="http://power.ti.com">power.ti.com</a>
Microcontrollers	<a href="http://microcontroller.ti.com">microcontroller.ti.com</a>
RFID	<a href="http://www.ti-rfid.com">www.ti-rfid.com</a>
OMAP Applications Processors	<a href="http://www.ti.com/omap">www.ti.com/omap</a>
Wireless Connectivity	<a href="http://www.ti.com/wirelessconnectivity">www.ti.com/wirelessconnectivity</a>

### Applications

Automotive and Transportation	<a href="http://www.ti.com/automotive">www.ti.com/automotive</a>
Communications and Telecom	<a href="http://www.ti.com/communications">www.ti.com/communications</a>
Computers and Peripherals	<a href="http://www.ti.com/computers">www.ti.com/computers</a>
Consumer Electronics	<a href="http://www.ti.com/consumer-apps">www.ti.com/consumer-apps</a>
Energy and Lighting	<a href="http://www.ti.com/energy">www.ti.com/energy</a>
Industrial	<a href="http://www.ti.com/industrial">www.ti.com/industrial</a>
Medical	<a href="http://www.ti.com/medical">www.ti.com/medical</a>
Security	<a href="http://www.ti.com/security">www.ti.com/security</a>
Space, Avionics and Defense	<a href="http://www.ti.com/space-avionics-defense">www.ti.com/space-avionics-defense</a>
Video and Imaging	<a href="http://www.ti.com/video">www.ti.com/video</a>

### TI E2E Community

[e2e.ti.com](http://e2e.ti.com)