

1.1nV/ $\sqrt{\text{Hz}}$ Noise, Low Power, Precision Operational Amplifier in Small DFN-8 Package

FEATURES

- **LOW VOLTAGE NOISE:** 1.1nV/ $\sqrt{\text{Hz}}$ at 1kHz
- **INPUT VOLTAGE NOISE:** 80nV_{PP} (0.1Hz to 10Hz)
- **THD+N:** –136dB (G = 1, f = 1kHz)
- **OFFSET VOLTAGE:** 125 μV (max)
- **OFFSET VOLTAGE DRIFT:** 0.35 $\mu\text{V}/^\circ\text{C}$ (typ)
- **LOW SUPPLY CURRENT:** 3.6mA/Ch (typ)
- **UNITY-GAIN STABLE**
- **GAIN BANDWIDTH PRODUCT:** 80MHz (G = 100)
45MHz (G = 1)
- **SLEW RATE:** 27V/ μs
- **16-BIT SETTling:** 700ns
- **WIDE SUPPLY RANGE:** $\pm 2.25\text{V}$ to $\pm 18\text{V}$, +4.5V to +36V
- **RAIL-TO-RAIL OUTPUT**
- **OUTPUT CURRENT:** 30mA
- **DFN-8 (3mm x 3mm), MSOP-8, AND SO-8**

APPLICATIONS

- **PLL LOOP FILTER**
- **LOW-NOISE, LOW-POWER SIGNAL PROCESSING**
- **16-BIT ADC DRIVERS**
- **DAC OUTPUT AMPLIFIERS**
- **ACTIVE FILTERS**
- **LOW-NOISE INSTRUMENTATION AMPS**
- **ULTRASOUND AMPLIFIERS**
- **PROFESSIONAL AUDIO PREAMPLIFIERS**
- **LOW-NOISE FREQUENCY SYNTHESIZERS**
- **INFRARED DETECTOR AMPLIFIERS**
- **HYDROPHONE AMPLIFIERS**
- **GEOPHONE AMPLIFIERS**
- **MEDICAL**

DESCRIPTION

The OPA211 series of precision operational amplifiers achieves very low 1.1nV/ $\sqrt{\text{Hz}}$ noise density with a supply current of only 3.6mA. This series also offers rail-to-rail output swing, which maximizes dynamic range.

The extremely low voltage and low current noise, high speed, and wide output swing of the OPA211 series make these devices an excellent choice as a loop filter amplifier in PLL applications.

In precision data acquisition applications, the OPA211 series of op amps provides 700ns settling time to 16-bit accuracy throughout 10V output swings. This ac performance, combined with only 125 μV of offset and 0.35 $\mu\text{V}/^\circ\text{C}$ of drift over temperature, makes the OPA211 ideal for driving high-precision 16-bit analog-to-digital converters (ADCs) or buffering the output of high-resolution digital-to-analog converters (DACs).

The OPA211 series is specified over a wide dual-power supply range of $\pm 2.25\text{V}$ to $\pm 18\text{V}$, or for single-supply operation from +4.5V to +36V.

The OPA211 is available in the small DFN-8 (3mm x 3mm), MSOP-8, and SO-8 packages. A dual version, the OPA2211, is available in the DFN-8 (3mm x 3mm) or an SO-8 PowerPAD™ package. This series of op amps is specified from $T_A = -40^\circ\text{C}$ to $+125^\circ\text{C}$.

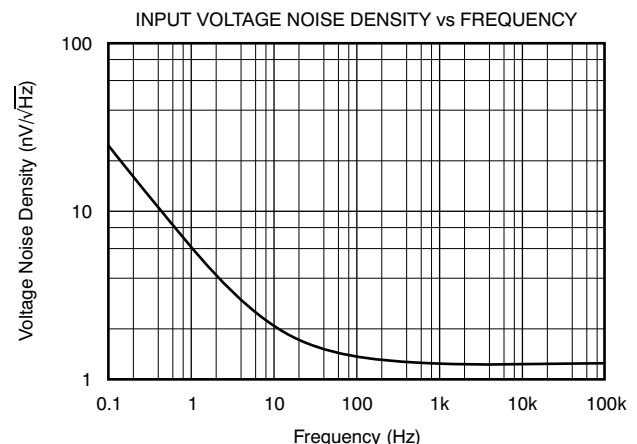

Please be aware that an important notice concerning availability, standard warranty, and use in critical applications of Texas Instruments semiconductor products and disclaimers thereto appears at the end of this data sheet.

PowerPAD is a trademark of Texas Instruments.

All other trademarks are the property of their respective owners.



This integrated circuit can be damaged by ESD. Texas Instruments recommends that all integrated circuits be handled with appropriate precautions. Failure to observe proper handling and installation procedures can cause damage.

ESD damage can range from subtle performance degradation to complete device failure. Precision integrated circuits may be more susceptible to damage because very small parametric changes could cause the device not to meet its published specifications.

ABSOLUTE MAXIMUM RATINGS⁽¹⁾

Over operating free-air temperature range (unless otherwise noted).

		VALUE	UNIT
Supply Voltage	$V_S = (V+) - (V-)$	40	V
Input Voltage		$(V-) - 0.5$ to $(V+) + 0.5$	V
Input Current (Any pin except power-supply pins)		±10	mA
Output Short-Circuit ⁽²⁾		Continuous	
Operating Temperature	(T_A)	–55 to +150	°C
Storage Temperature	(T_A)	–65 to +150	°C
Junction Temperature	(T_J)	200	°C
ESD Ratings	Human Body Model (HBM)	3000	V
	Charged Device Model (CDM)	1000	V

- (1) Stresses above these ratings may cause permanent damage. Exposure to absolute maximum conditions for extended periods may degrade device reliability. These are stress ratings only, and functional operation of the device at these or any other conditions beyond those specified is not supported.
- (2) Short-circuit to $V_S/2$ (ground in symmetrical dual supply setups), one amplifier per package.

PACKAGE/ORDERING INFORMATION⁽¹⁾

PRODUCT	PACKAGE-LEAD	SINGLE	SHUTDOWN	DUAL	PACKAGE DESIGNATOR	PACKAGE MARKING
Standard Grade						
OPA211AI	DFN-8 (3mm × 3mm)	✓	✓		DRG	OBDAQ
	MSOP-8	✓	✓		DGK	OBCAQ
	SO-8	✓			D	A TI OPA 211
OPA2211AI	DFN-8 (3mm × 3mm)			✓	DRG	OBHAQ
	SO-8 PowerPAD			✓	DDA	A TI OPA 2211
High Grade						
OPA211I	DFN-8 (3mm × 3mm)	✓	✓		DRG	OBDAQ
	MSOP-8	✓	✓		DGK	OBCAQ
	SO-8	✓			D	TI OPA 211

- (1) For the most current package and ordering information see the Package Option Addendum at the end of this document, or see the TI web site at www.ti.com.

PIN CONFIGURATIONS

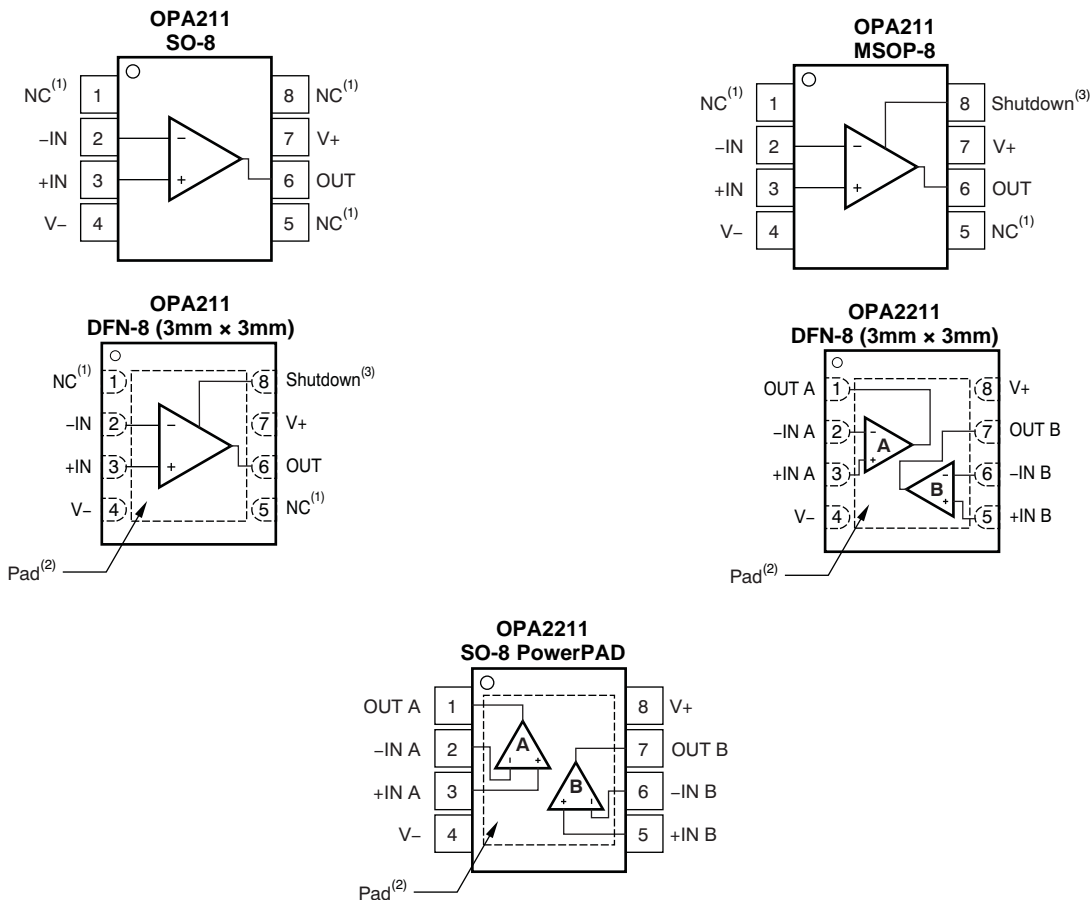

(1) NC denotes no internal connection.

(2) Exposed thermal die pad on underside; connect thermal die pad to V-. Soldering the thermal pad improves heat dissipation and provides specified performance.

(3) Shutdown function:

- Device enabled: $(V-) \leq V_{\text{SHUTDOWN}} \leq (V+) - 3V$
- Device disabled: $V_{\text{SHUTDOWN}} \geq (V+) - 0.35V$

ELECTRICAL CHARACTERISTICS: $V_S = \pm 2.25V$ to $\pm 18V$

BOLDFACE limits apply over the specified temperature range, $T_A = -40^\circ C$ to $+125^\circ C$.

At $T_A = +25^\circ C$, $R_L = 10k\Omega$ connected to midsupply, $V_{CM} = V_{OUT} =$ midsupply, unless otherwise noted.

PARAMETER	CONDITIONS	Standard Grade OPA211AI, OPA2211AI			High Grade OPA211 ⁽¹⁾			UNIT	
		MIN	TYP	MAX	MIN	TYP	MAX		
OFFSET VOLTAGE									
Input Offset Voltage	V_{OS}								
OPA211	$V_S = \pm 15V$		± 30	± 125		± 20	± 50	μV	
OPA2211	$V_S = \pm 15V$		± 50	± 150				μV	
Drift	dV_{OS}/dT		0.35	1.5		0.15	0.85	$\mu V/^\circ C$	
vs Power Supply	PSRR	$V_S = \pm 2.25V$ to $\pm 18V$	0.1	1		0.1	0.5	$\mu V/V$	
Over Temperature				3			3	$\mu V/V$	
INPUT BIAS CURRENT									
Input Bias Current	I_B	$V_{CM} = 0V$		± 60	± 175		± 50	± 125	nA
Over Temperature									
OPA211				± 200			± 200		nA
OPA2211				± 250					nA
Offset Current	I_{OS}	$V_{CM} = 0V$	± 25	± 100		± 20	± 75		nA
Over Temperature				± 150			± 150		nA
NOISE									
Input Voltage Noise	e_n	$f = 0.1Hz$ to $10Hz$		80		80			nV _{PP}
Input Voltage Noise Density		$f = 10Hz$		2		2			nV/ \sqrt{Hz}
		$f = 100Hz$		1.4		1.4			nV/ \sqrt{Hz}
		$f = 1kHz$		1.1		1.1			nV/ \sqrt{Hz}
Input Current Noise Density	i_n	$f = 10Hz$		3.2		3.2			pA/ \sqrt{Hz}
		$f = 1kHz$		1.7		1.7			pA/ \sqrt{Hz}
INPUT VOLTAGE RANGE									
Common-Mode Voltage Range	V_{CM}	$V_S \geq \pm 5V$	$(V-) + 1.8$		$(V+) - 1.4$	$(V-) + 1.8$		$(V+) - 1.4$	V
		$V_S < \pm 5V$	$(V-) + 2$		$(V+) - 1.4$	$(V-) + 2$		$(V+) - 1.4$	V
Common-Mode Rejection Ratio	CMRR	$V_S \geq \pm 5V, (V-) + 2V \leq V_{CM} \leq (V+) - 2V$	114	120		114	120		dB
		$V_S < \pm 5V, (V-) + 2V \leq V_{CM} \leq (V+) - 2V$	110	120		110	120		dB
INPUT IMPEDANCE									
Differential				$20k \parallel 8$		$20k \parallel 8$			$\Omega \parallel pF$
Common-Mode				$10^9 \parallel 2$		$10^9 \parallel 2$			$\Omega \parallel pF$
OPEN-LOOP GAIN									
Open-Loop Voltage Gain	A_{OL}	$(V-) + 0.2V \leq V_O \leq (V+) - 0.2V, R_L = 10k\Omega$	114	130		114	130		dB
	A_{OL}	$(V-) + 0.6V \leq V_O \leq (V+) - 0.6V, R_L = 600\Omega$	110	114		110	114		dB
Over Temperature									
OPA211	A_{OL}	$(V-) + 0.6V \leq V_O \leq (V+) - 0.6V, I_O \leq 15mA$	110			110			dB
OPA211	A_{OL}	$(V-) + 0.6V \leq V_O \leq (V+) - 0.6V, 15mA \leq I_O \leq 30mA$	103			103			dB
OPA2211 (per channel)	A_{OL}	$(V-) + 0.6V \leq V_O \leq (V+) - 0.6V, I_O \leq 15mA$	100						dB
FREQUENCY RESPONSE									
Gain-Bandwidth Product	GBW	$G = 100$		80		80			MHz
		$G = 1$		45		45			MHz
Slew Rate	SR			27		27			V/ μs
Settling Time, 0.01%	t_s	$V_S = \pm 15V, G = -1, 10V$ Step, $C_L = 100pF$		400		400			ns
0.0015% (16-bit)		$V_S = \pm 15V, G = -1, 10V$ Step, $C_L = 100pF$		700		700			ns
Overload Recovery Time		$G = -10$		500		500			ns
Total Harmonic Distortion + Noise	THD+N	$G = +1, f = 1kHz, V_O = 3V_{RMS}, R_L = 600\Omega$		0.000015		0.000015			%
				-136		-136			dB

(1) Shaded cells indicate different specifications from standard-grade version of device.

ELECTRICAL CHARACTERISTICS: $V_S = \pm 2.25V$ to $\pm 18V$ (continued)
BOLDFACE limits apply over the specified temperature range, $T_A = -40^\circ C$ to $+125^\circ C$.

 At $T_A = +25^\circ C$, $R_L = 10k\Omega$ connected to midsupply, $V_{CM} = V_{OUT} =$ midsupply, unless otherwise noted.

PARAMETER	CONDITIONS	Standard Grade OPA211AI, OPA2211AI			High Grade OPA211 ⁽¹⁾			UNIT
		MIN	TYP	MAX	MIN	TYP	MAX	
OUTPUT								
Voltage Output V_{OUT}	$R_L = 10k\Omega$, $A_{OL} \geq 114dB$ $R_L = 600\Omega$, $A_{OL} \geq 110dB$ $I_O < 15mA$, $A_{OL} \geq 110dB$	$(V-) + 0.2$		$(V+) - 0.2$	$(V-) + 0.2$		$(V+) - 0.2$	V
		$(V-) + 0.6$		$(V+) - 0.6$	$(V-) + 0.6$		$(V+) - 0.6$	V
		$(V-) + 0.6$		$(V+) - 0.6$	$(V-) + 0.6$		$(V+) - 0.6$	V
Short-Circuit Current I_{SC}			+30/-45			+30/-45		mA
Capacitive Load Drive C_{LOAD}		See Typical Characteristics			See Typical Characteristics			pF
Open-Loop Output Impedance Z_O	$f = 1MHz$		5			5		Ω
SHUTDOWN								
Shutdown Pin Input Voltage ⁽²⁾	Device disabled (shutdown)	$(V+) - 0.35$			$(V+) - 0.35$			V
	Device enabled			$(V+) - 3$			$(V+) - 3$	V
Shutdown Pin Leakage Current			1			1		μA
Turn-On Time ⁽³⁾			2			2		μs
Turn-Off Time ⁽³⁾			3			3		μs
Shutdown Current	Shutdown (disabled)		1	20		1	20	μA
POWER SUPPLY								
Specified Voltage V_S		± 2.25		± 18	± 2.25		± 18	V
Quiescent Current (per channel) I_Q	$I_{OUT} = 0A$		3.6	4.5		3.6	4.5	mA
		Over Temperature (per channel)			6			6
TEMPERATURE RANGE								
Specified Range T_A		-40		+125	-40		+125	$^\circ C$
Operating Range T_A		-55		+150	-55		+150	$^\circ C$
Thermal Resistance								
OPA211								
SO-8 θ_{JA}			150			150		$^\circ C/W$
MSOP-8 θ_{JA}			200			200		$^\circ C/W$
DFN-8 (3mm x 3mm) θ_{JA} ⁽⁴⁾			65			65		$^\circ C/W$
θ_{JP}			20			20		$^\circ C/W$
OPA2211								
SO-8 PowerPAD θ_{JA} ⁽⁴⁾			52			52		$^\circ C/W$
θ_{JP}			2			2		$^\circ C/W$
DFN-8 (3mm x 3mm) θ_{JA} ⁽⁴⁾			65			65		$^\circ C/W$
θ_{JP}			10			10		$^\circ C/W$

- (2) When disabled, the output assumes a high-impedance state.
 (3) See [Typical Characteristic](#) graphs, [Figure 41](#) through [Figure 43](#).
 (4) Typical θ_{JA} specification is based on the use of a high-k board.

TYPICAL CHARACTERISTICS

At $T_A = +25^\circ\text{C}$, $V_S = \pm 18\text{V}$, and $R_L = 10\text{k}\Omega$, unless otherwise noted.

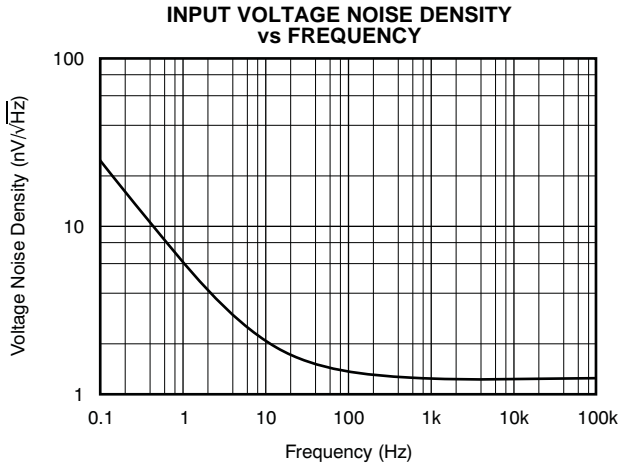

Figure 1.

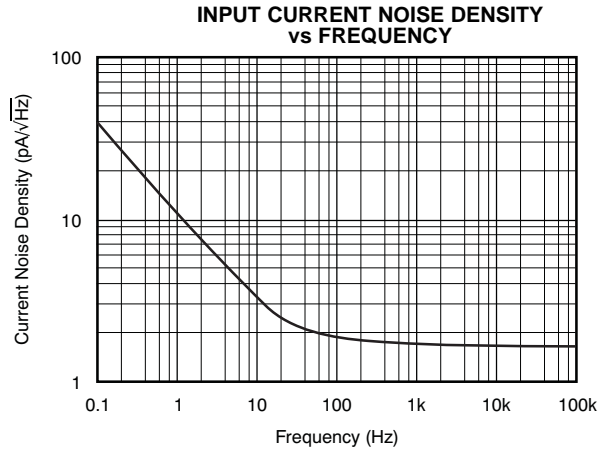

Figure 2.

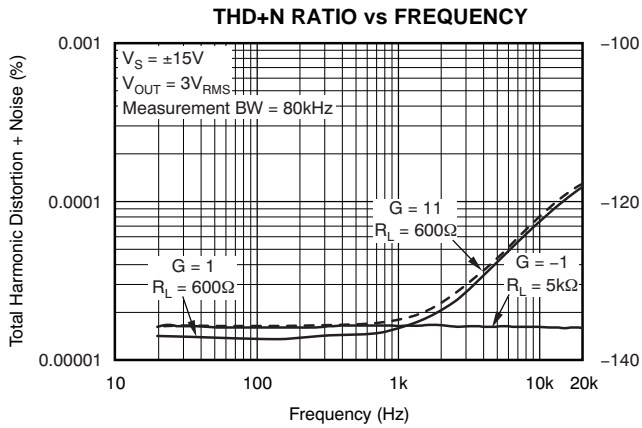

Figure 3.

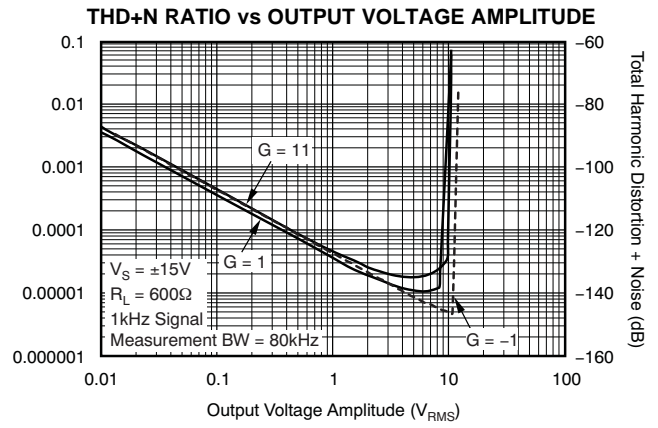

Figure 4.

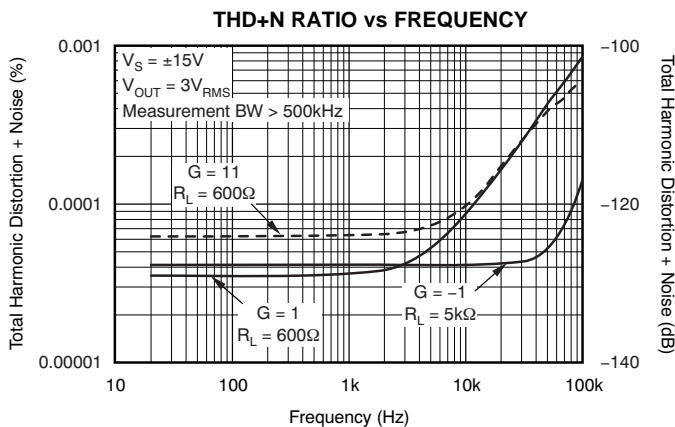

Figure 5.

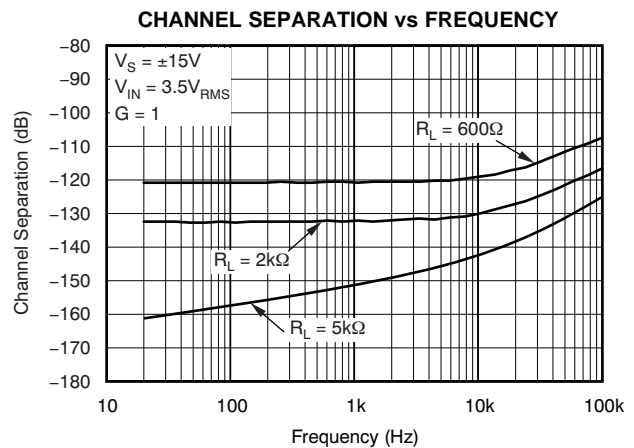

Figure 6.

TYPICAL CHARACTERISTICS (continued)

At $T_A = +25^\circ\text{C}$, $V_S = \pm 18\text{V}$, and $R_L = 10\text{k}\Omega$, unless otherwise noted.

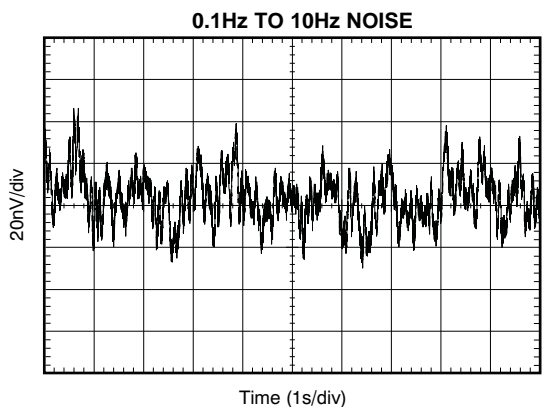

Figure 7.

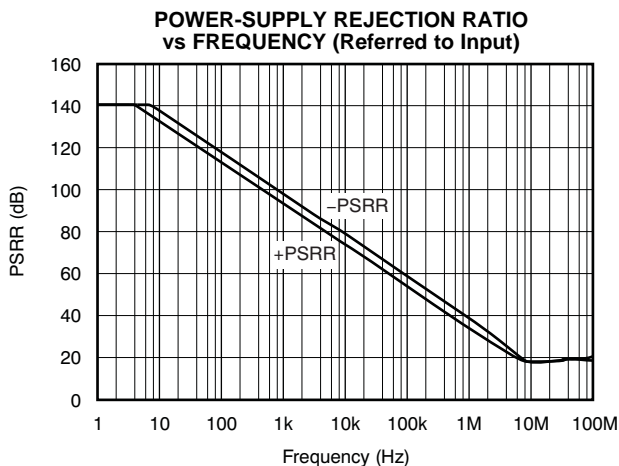

Figure 8.

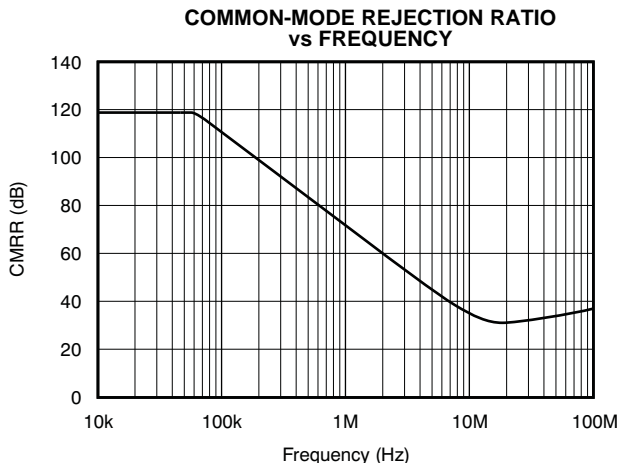

Figure 9.

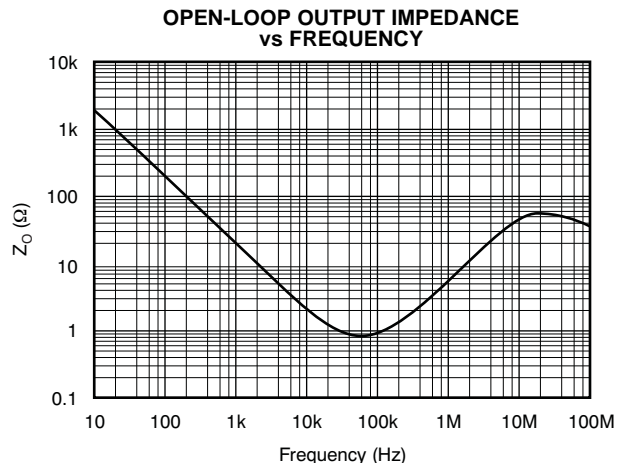

Figure 10.

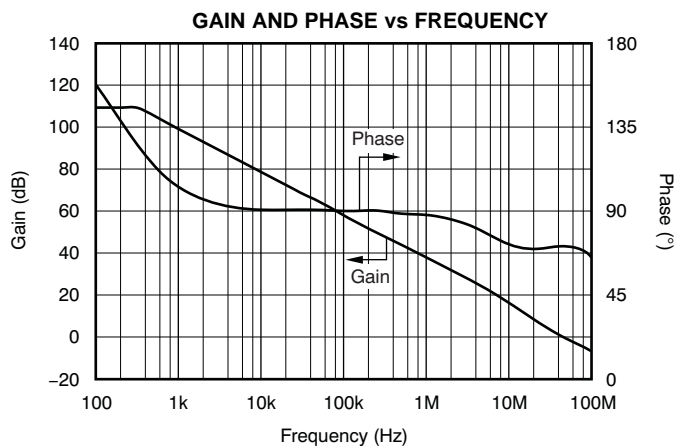

Figure 11.

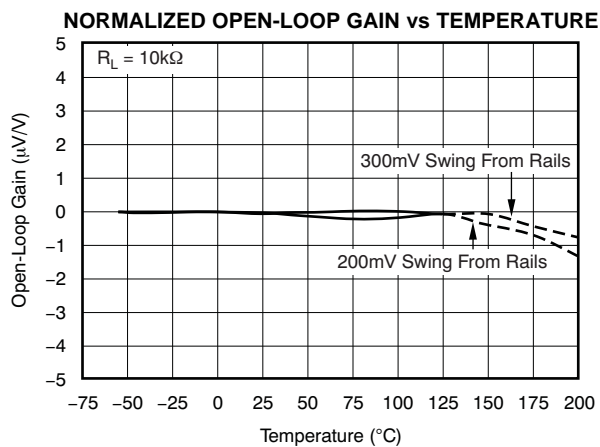

Figure 12.

TYPICAL CHARACTERISTICS (continued)

At $T_A = +25^\circ\text{C}$, $V_S = \pm 18\text{V}$, and $R_L = 10\text{k}\Omega$, unless otherwise noted.

OFFSET VOLTAGE PRODUCTION DISTRIBUTION

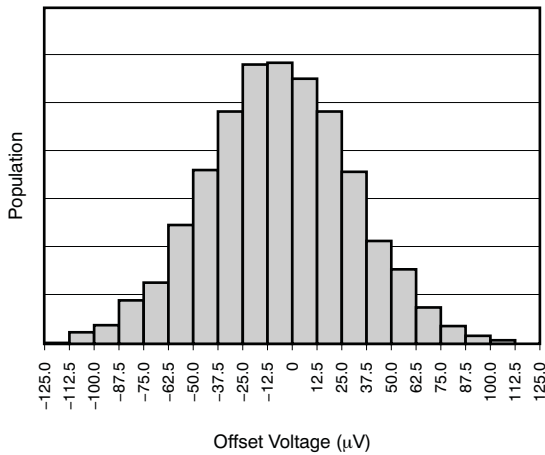

Figure 13.

OFFSET VOLTAGE DRIFT PRODUCTION DISTRIBUTION

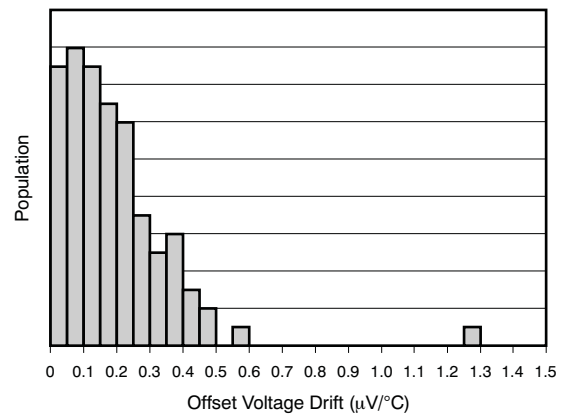

Figure 14.

I_B AND I_{OS} CURRENT vs TEMPERATURE

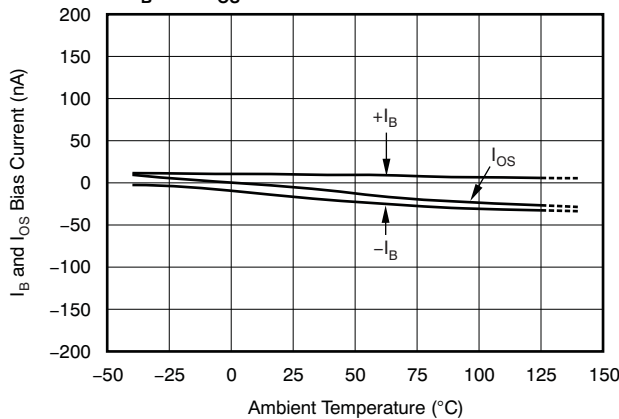

Figure 15.

OFFSET VOLTAGE vs COMMON-MODE VOLTAGE

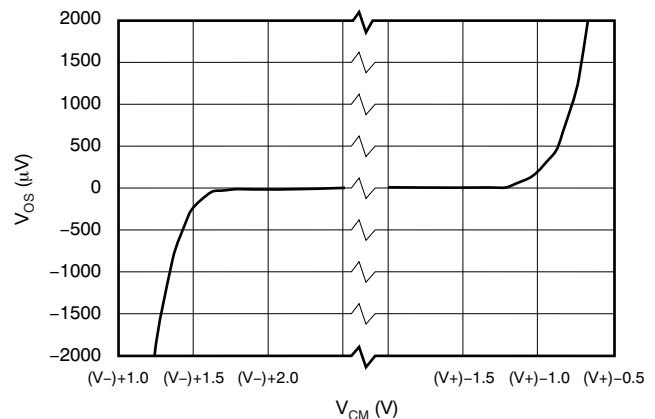

Figure 16.

V_{OS} WARMUP

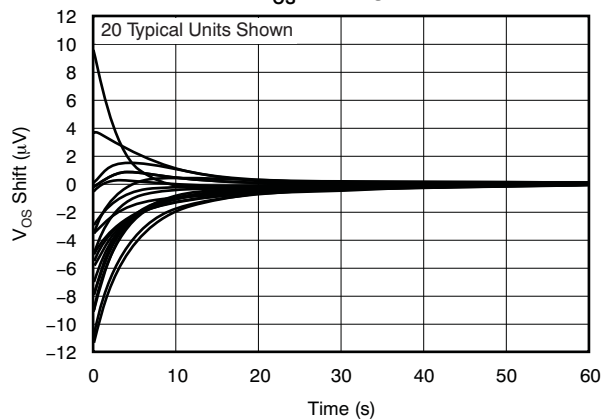

Figure 17.

INPUT OFFSET CURRENT vs SUPPLY VOLTAGE

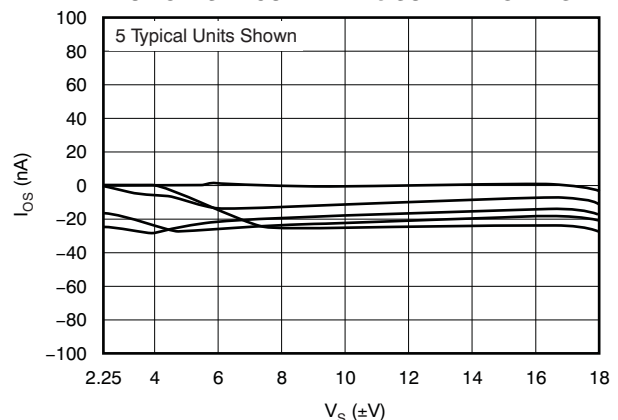

Figure 18.

TYPICAL CHARACTERISTICS (continued)

At $T_A = +25^\circ\text{C}$, $V_S = \pm 18\text{V}$, and $R_L = 10\text{k}\Omega$, unless otherwise noted.

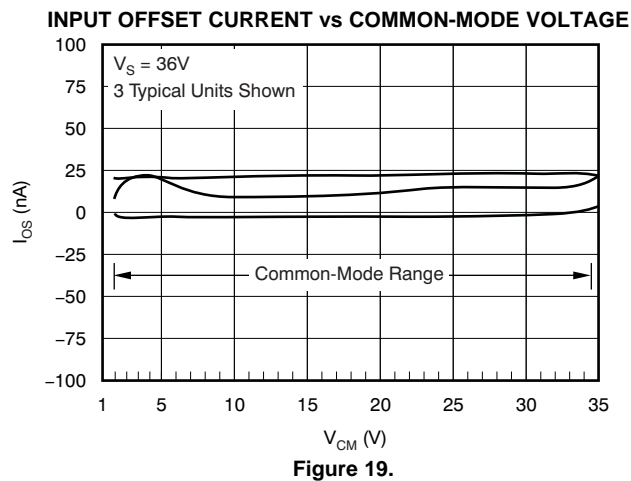

Figure 19.

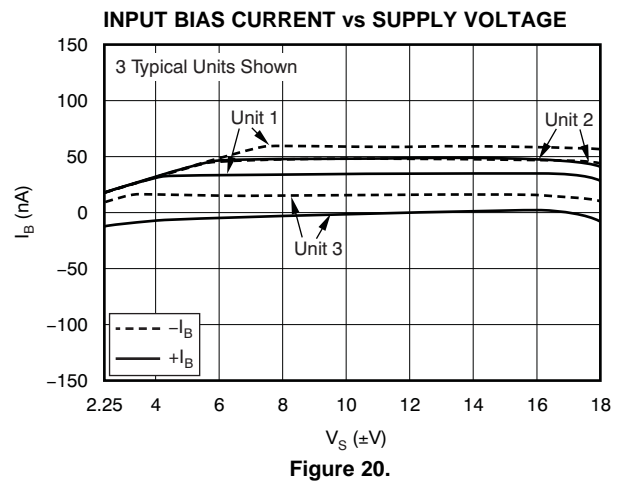

Figure 20.

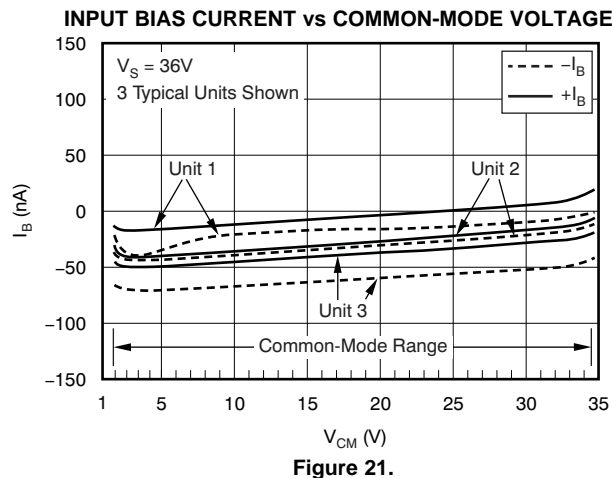

Figure 21.

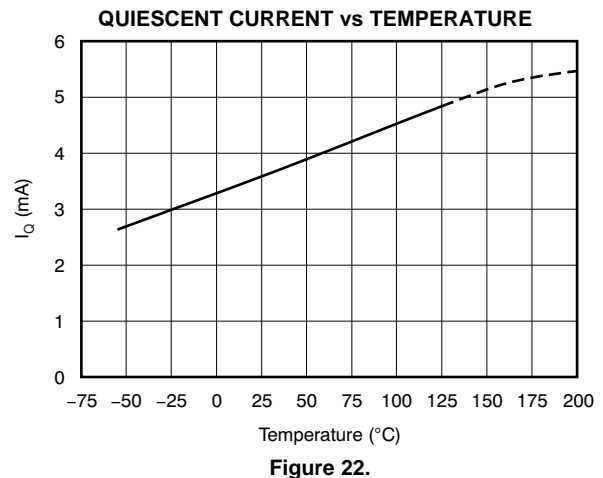

Figure 22.

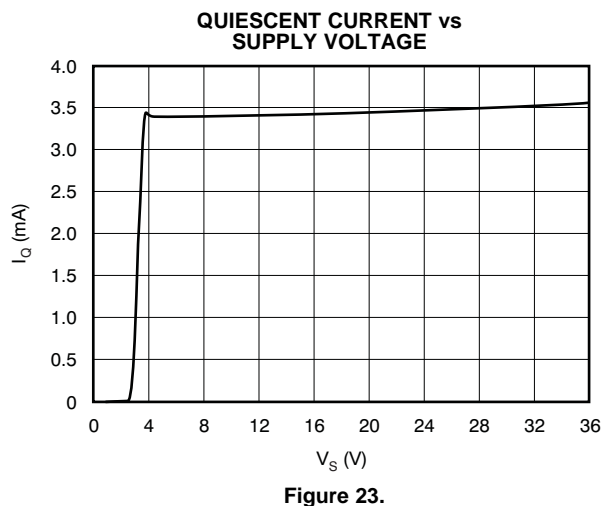

Figure 23.

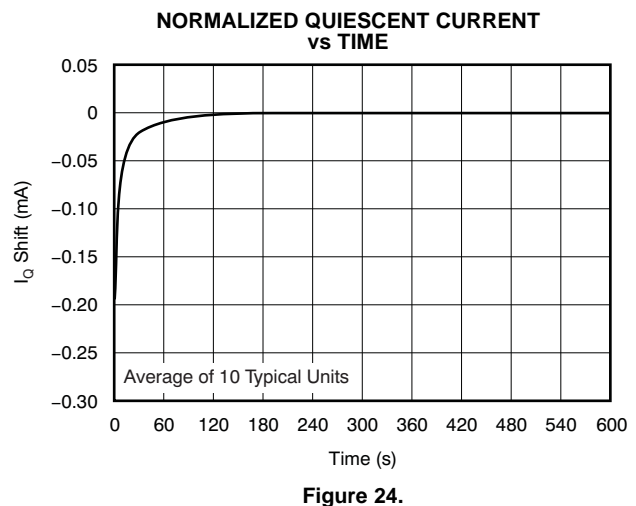

Figure 24.

TYPICAL CHARACTERISTICS (continued)

At $T_A = +25^\circ\text{C}$, $V_S = \pm 18\text{V}$, and $R_L = 10\text{k}\Omega$, unless otherwise noted.

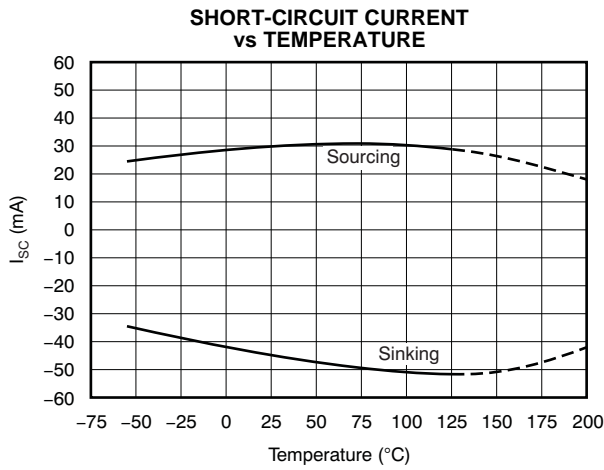

Figure 25.

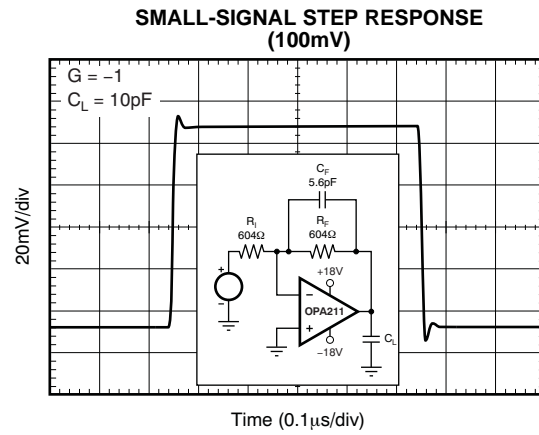

Figure 26.

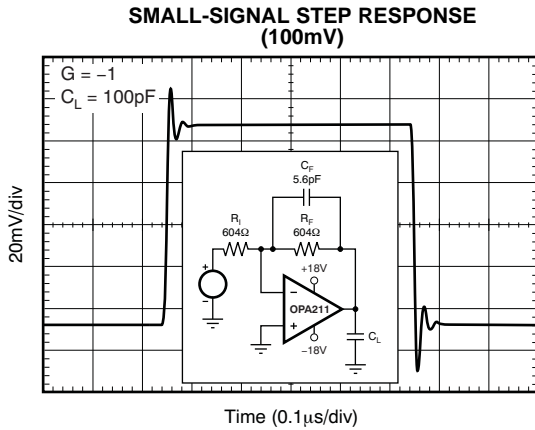

Figure 27.

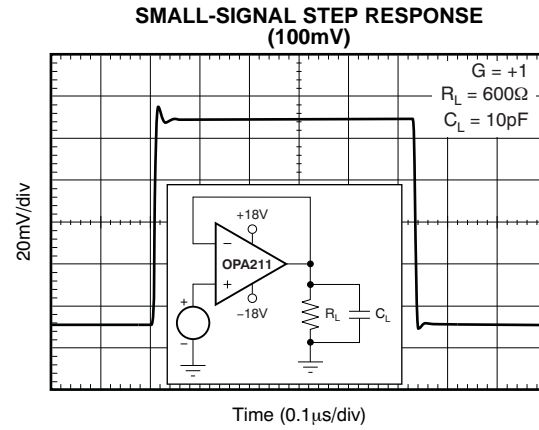

Figure 28.

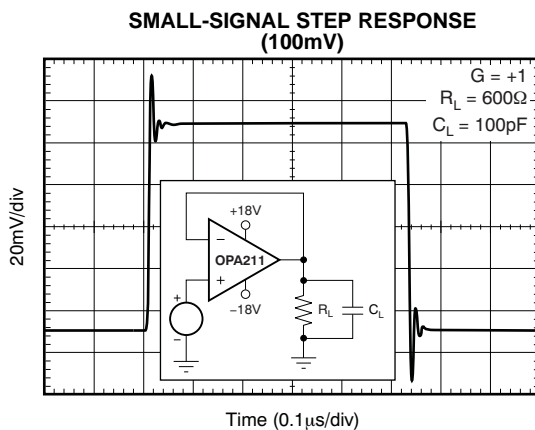

Figure 29.

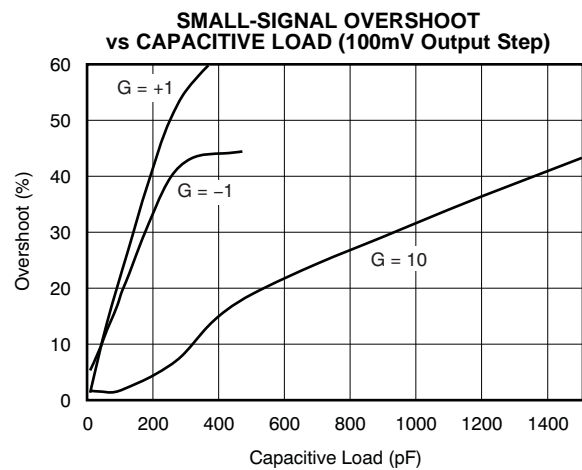

Figure 30.

TYPICAL CHARACTERISTICS (continued)

At $T_A = +25^\circ\text{C}$, $V_S = \pm 18\text{V}$, and $R_L = 10\text{k}\Omega$, unless otherwise noted.

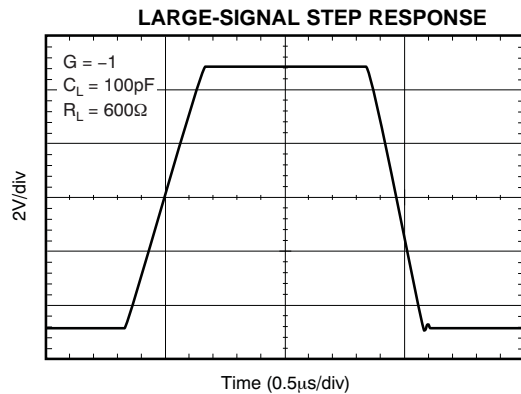

Figure 31.

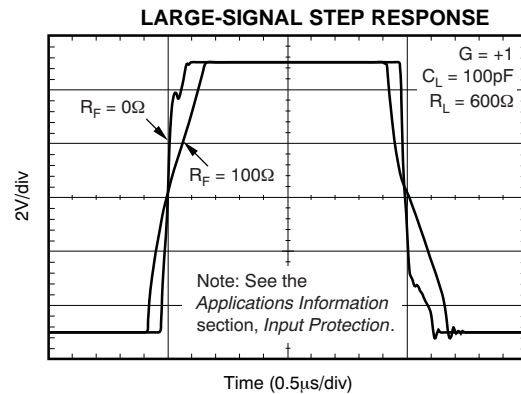

Figure 32.

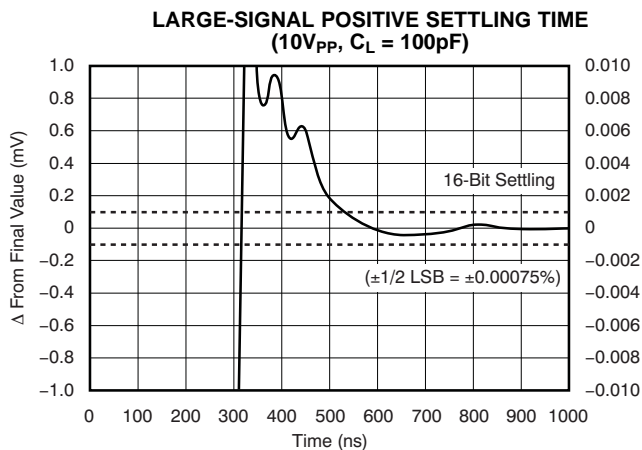

Figure 33.

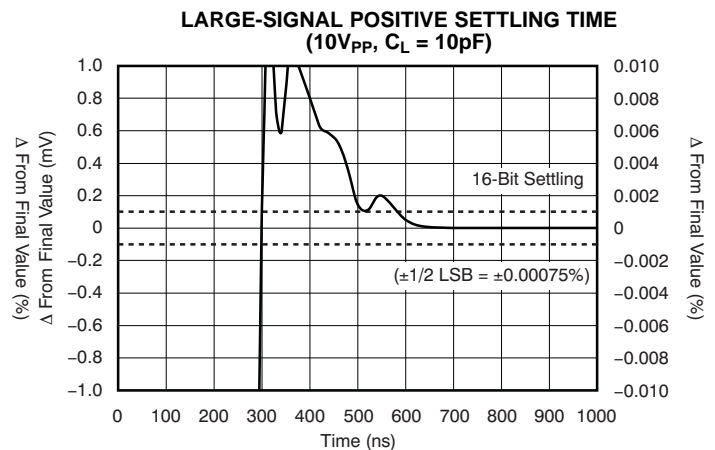

Figure 34.

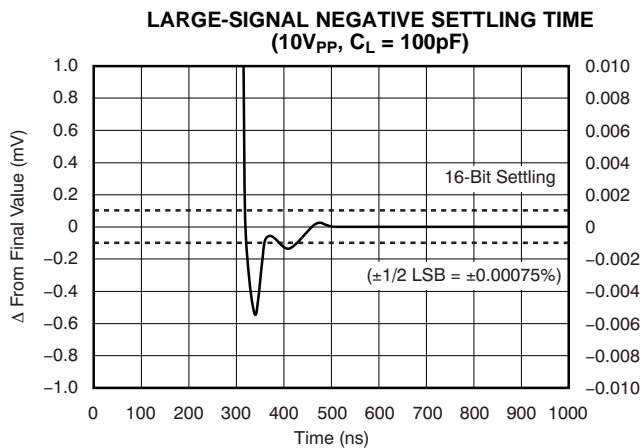

Figure 35.

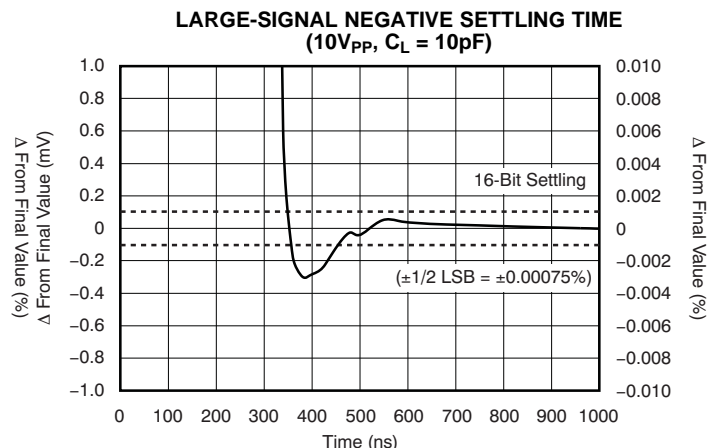
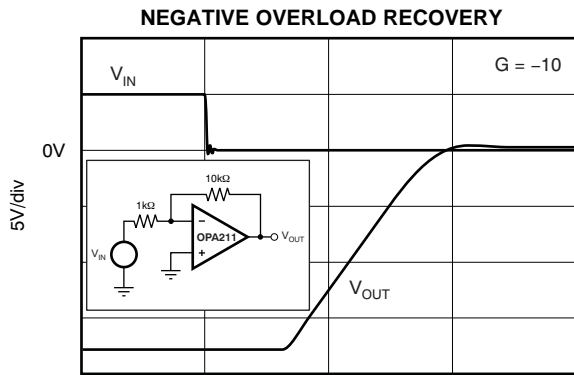

Figure 36.

TYPICAL CHARACTERISTICS (continued)

At $T_A = +25^\circ\text{C}$, $V_S = \pm 18\text{V}$, and $R_L = 10\text{k}\Omega$, unless otherwise noted.



Time (0.5μs/div)
Figure 37.

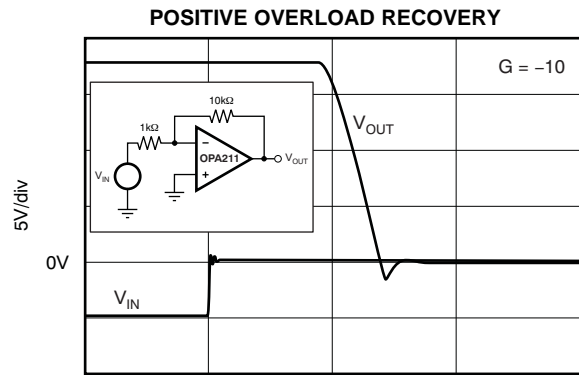

Time (0.5μs/div)
Figure 38.

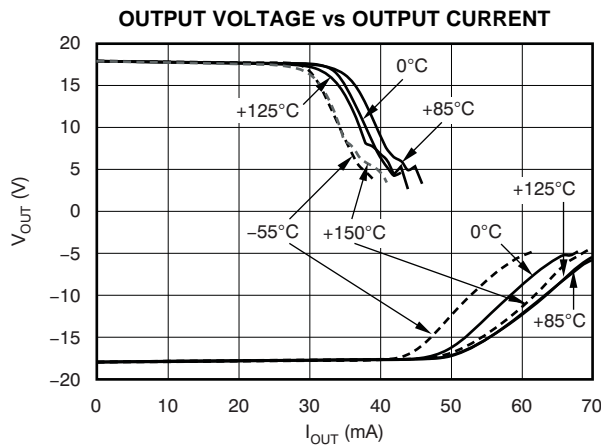

Figure 39.

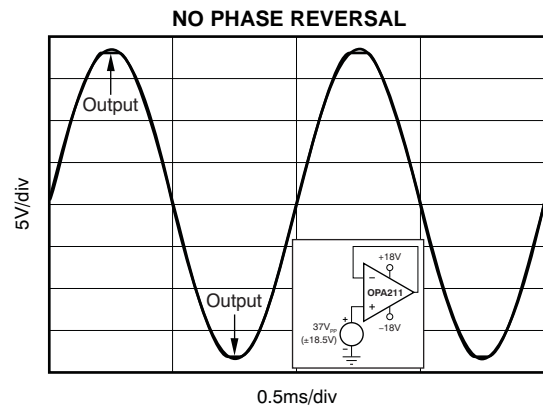
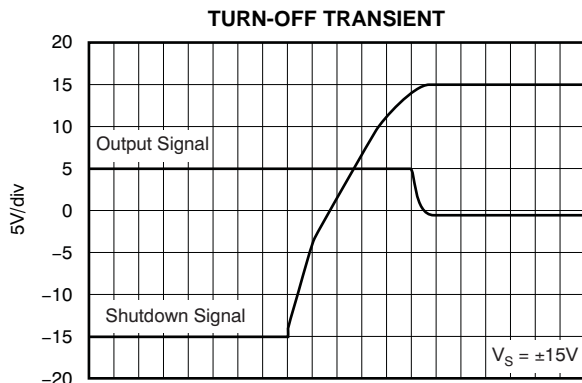
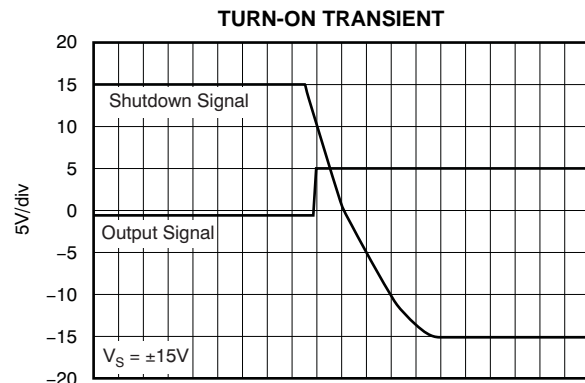

Figure 40.



Time (2μs/div)
Figure 41.



Time (2μs/div)
Figure 42.

TYPICAL CHARACTERISTICS (continued)

At $T_A = +25^\circ\text{C}$, $V_S = \pm 18\text{V}$, and $R_L = 10\text{k}\Omega$, unless otherwise noted.

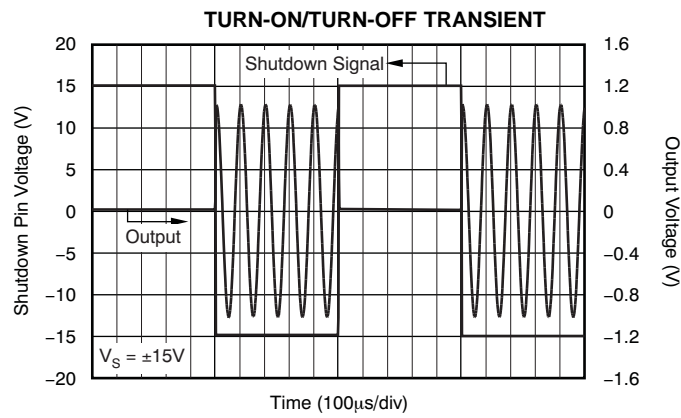

Figure 43.

APPLICATION INFORMATION

The OPA211 and OPA2211 are unity-gain stable, precision op amps with very low noise. Applications with noisy or high-impedance power supplies require decoupling capacitors close to the device pins. In most cases, 0.1 μ F capacitors are adequate. [Figure 44](#) shows a simplified schematic of the OPA211. This die uses a SiGe bipolar process and contains 180 transistors.

OPERATING VOLTAGE

OPA211 series op amps operate from ± 2.25 V to ± 18 V supplies while maintaining excellent performance. The OPA211 series can operate with as little as +4.5V between the supplies and with up to +36V between the supplies. However, some applications do not require equal positive and

negative output voltage swing. With the OPA211 series, power-supply voltages do not need to be equal. For example, the positive supply could be set to +25V with the negative supply at -5V or vice-versa.

The common-mode voltage must be maintained within the specified range. In addition, key parameters are assured over the specified temperature range, $T_A = -40^{\circ}\text{C}$ to $+125^{\circ}\text{C}$. Parameters that vary significantly with operating voltage or temperature are shown in the [Typical Characteristics](#).

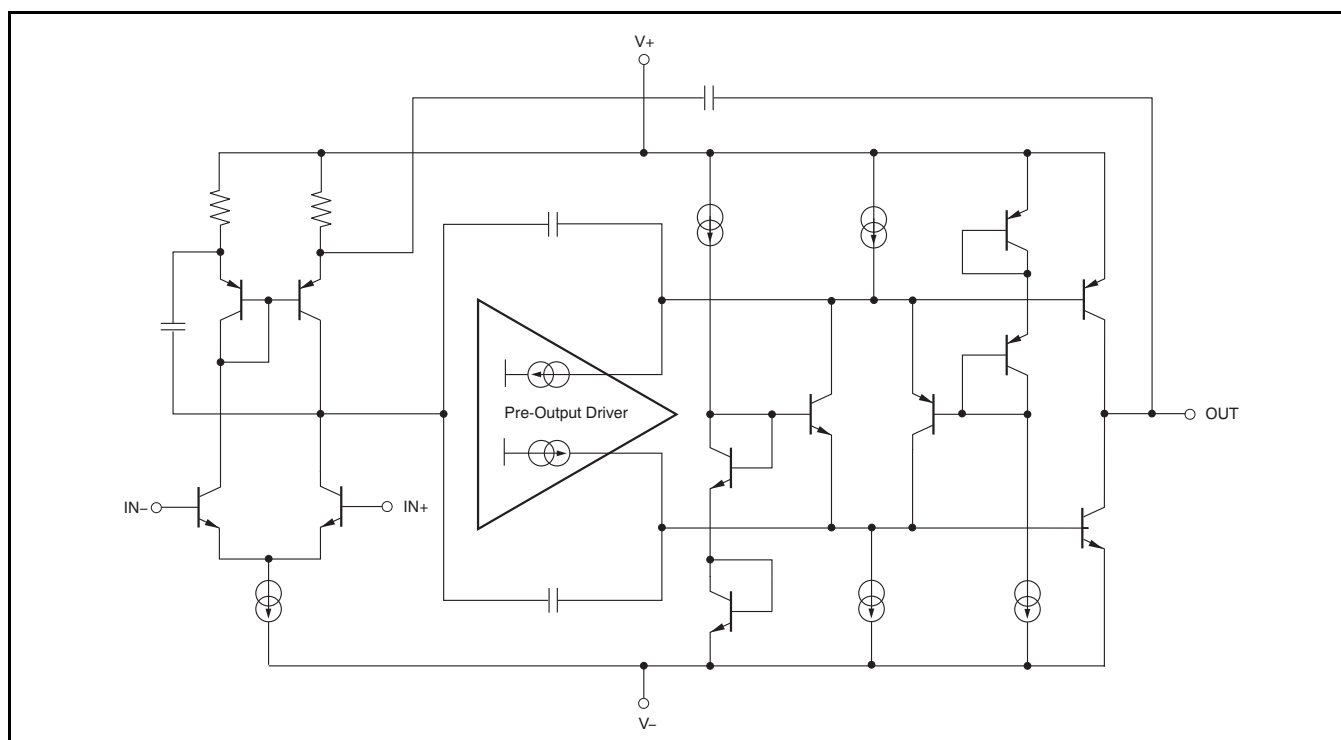

Figure 44. OPA211 Simplified Schematic

INPUT PROTECTION

The input terminals of the OPA211 are protected from excessive differential voltage with back-to-back diodes, as shown in Figure 45. In most circuit applications, the input protection circuitry has no consequence. However, in low-gain or $G = 1$ circuits, fast ramping input signals can forward bias these diodes because the output of the amplifier cannot respond rapidly enough to the input ramp. This effect is illustrated in Figure 32 of the Typical Characteristics. If the input signal is fast enough to create this forward bias condition, the input signal current must be limited to 10mA or less. If the input signal current is not inherently limited, an input series resistor can be used to limit the signal input current. This input series resistor degrades the low-noise performance of the OPA211, and is discussed in the *Noise Performance* section of this data sheet. Figure 45 shows an example implementing a current-limiting feedback resistor.

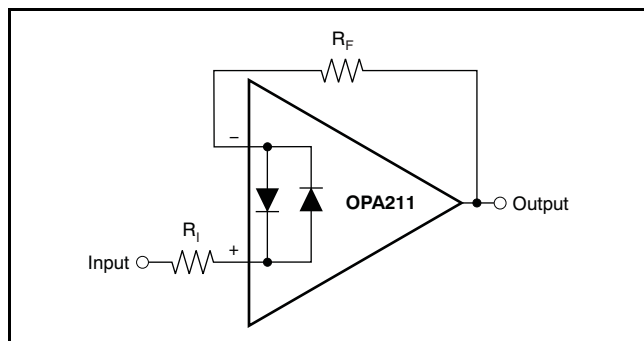

Figure 45. Pulsed Operation

SHUTDOWN

The shutdown (enable) function of the OPA211 is referenced to the positive supply voltage of the operational amplifier. A valid high disables the op amp. A valid high is defined as $(V+) - 0.35V$ of the positive supply applied to the shutdown pin. A valid low is defined as $(V+) - 3V$ below the positive supply pin. For example, with V_{CC} at $\pm 15V$, the device is enabled at or below 12V. The device is disabled at or above 14.65V. If dual or split power supplies are used, care should be taken to ensure the valid high or valid low input signals are properly referred to the positive supply voltage. This pin must be connected to a valid high or low voltage or driven, and not left open-circuit. The enable and disable times are provided in the *Typical Characteristics* section (see Figure 41 through Figure 43). When disabled, the output assumes a high-impedance state.

NOISE PERFORMANCE

Figure 46 shows total circuit noise for varying source impedances with the op amp in a unity-gain configuration (no feedback resistor network, and therefore no additional noise contributions). Two different op amps are shown with total circuit noise calculated. The OPA211 has very low voltage noise, making it ideal for low source impedances (less than 2k Ω). A similar precision op amp, the OPA227, has somewhat higher voltage noise but lower current noise. It provides excellent noise performance at moderate source impedance (10k Ω to 100k Ω). Above 100k Ω , a FET-input op amp such as the OPA132 (very low current noise) may provide improved performance. The equation in Figure 46 is shown for the calculation of the total circuit noise. Note that e_n = voltage noise, I_n = current noise, R_S = source impedance, k = Boltzmann's constant = 1.38×10^{-23} J/K, and T is temperature in degrees Kelvin.

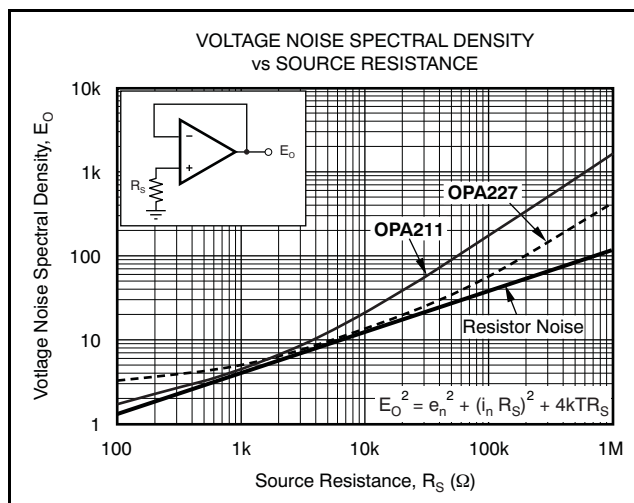

Figure 46. Noise Performance of the OPA211 and OPA227 in Unity-Gain Buffer Configuration

BASIC NOISE CALCULATIONS

Design of low-noise op amp circuits requires careful consideration of a variety of possible noise contributors: noise from the signal source, noise generated in the op amp, and noise from the feedback network resistors. The total noise of the circuit is the root-sum-square combination of all noise components.

The resistive portion of the source impedance produces thermal noise proportional to the square root of the resistance. This function is plotted in Figure 46. The source impedance is usually fixed; consequently, select the op amp and the feedback resistors to minimize the respective contributions to the total noise.

Figure 46 depicts total noise for varying source impedances with the op amp in a unity-gain configuration (no feedback resistor network, and therefore no additional noise contributions). The operational amplifier itself contributes both a voltage noise component and a current noise component. The voltage noise is commonly modeled as a time-varying component of the offset voltage. The current noise is modeled as the time-varying component of the input bias current and reacts with the source resistance to create a voltage component of noise.

Therefore, the lowest noise op amp for a given application depends on the source impedance. For low source impedance, current noise is negligible and voltage noise generally dominates. For high source impedance, current noise may dominate.

Figure 47 illustrates both inverting and noninverting op amp circuit configurations with gain. In circuit configurations with gain, the feedback network resistors also contribute noise. The current noise of the op amp reacts with the feedback resistors to create additional noise components. The feedback resistor values can generally be chosen to make these noise sources negligible. The equations for total noise are shown for both configurations.

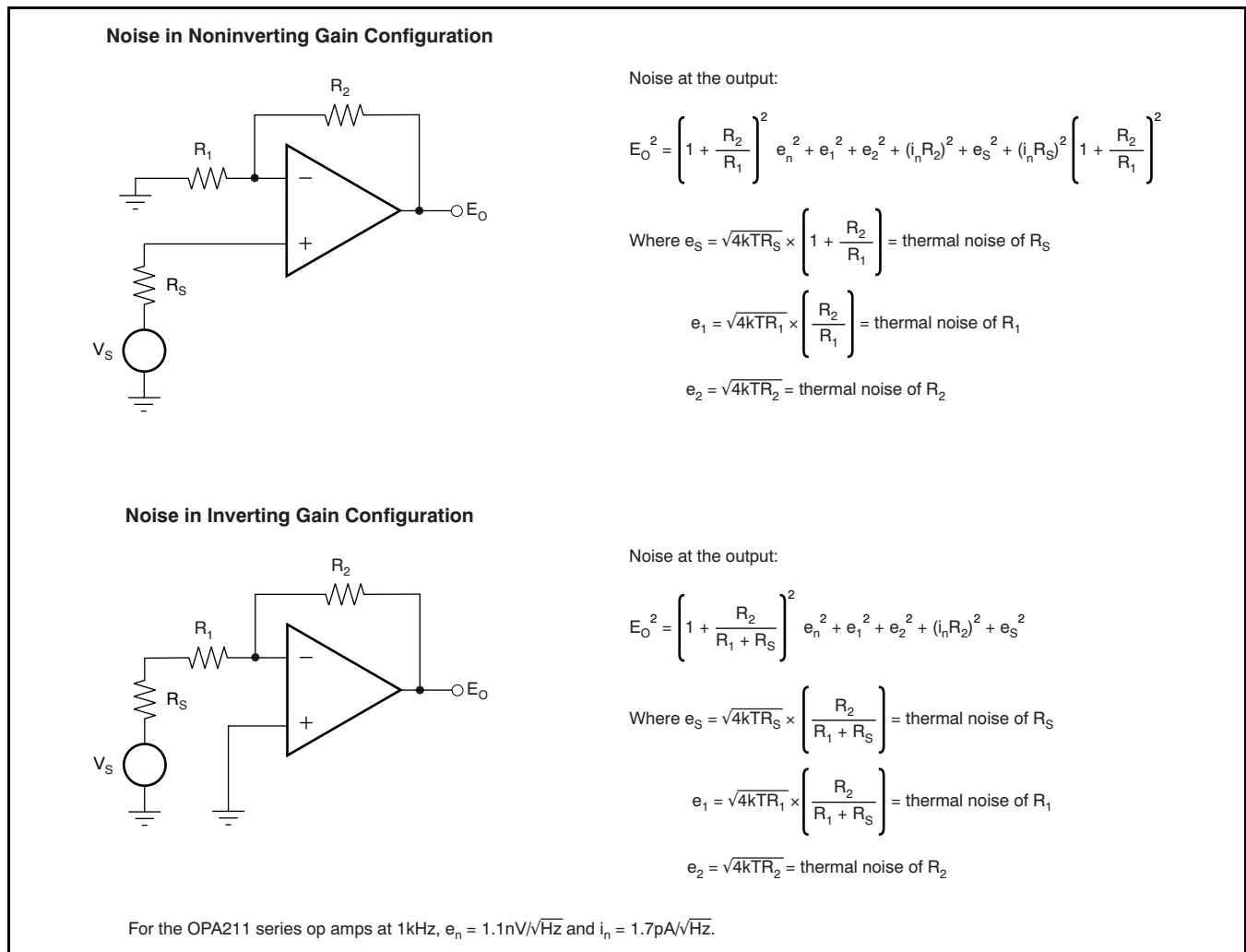

Figure 47. Noise Calculation in Gain Configurations

TOTAL HARMONIC DISTORTION MEASUREMENTS

OPA211 series op amps have excellent distortion characteristics. THD + Noise is below 0.0002% ($G = +1$, $V_{OUT} = 3V_{RMS}$) throughout the audio frequency range, 20Hz to 20kHz, with a 600Ω load.

The distortion produced by OPA211 series op amps is below the measurement limit of many commercially available distortion analyzers. However, a special test circuit illustrated in Figure 48 can be used to extend the measurement capabilities.

Op amp distortion can be considered an internal error source that can be referred to the input. Figure 48 shows a circuit that causes the op amp distortion to be 101 times greater than that normally produced by the op amp. The addition of R_3 to the otherwise standard noninverting amplifier configuration alters the feedback factor or noise gain of the circuit. The closed-loop gain is unchanged, but the feedback available for error correction is reduced by a factor of 101, thus extending the resolution by 101. Note that the input signal and load applied to the op amp are the same as with conventional feedback without R_3 . The value of R_3 should be kept small to minimize its effect on the distortion measurements.

Validity of this technique can be verified by duplicating measurements at high gain and/or high frequency where the distortion is within the measurement capability of the test equipment. Measurements for this data sheet were made with an

Audio Precision System Two distortion/noise analyzer, which greatly simplifies such repetitive measurements. The measurement technique can, however, be performed with manual distortion measurement instruments.

ELECTRICAL OVERSTRESS

Designers often ask questions about the capability of an operational amplifier to withstand electrical overstress. These questions tend to focus on the device inputs, but may involve the supply voltage pins or even the output pin. Each of these different pin functions have electrical stress limits determined by the voltage breakdown characteristics of the particular semiconductor fabrication process and specific circuits connected to the pin. Additionally, internal electrostatic discharge (ESD) protection is built into these circuits to protect them from accidental ESD events both before and during product assembly.

It is helpful to have a good understanding of this basic ESD circuitry and its relevance to an electrical overstress event. See Figure 49 for an illustration of the ESD circuits contained in the OPA211 (indicated by the dashed line area). The ESD protection circuitry involves several current-steering diodes connected from the input and output pins and routed back to the internal power-supply lines, where they meet at an absorption device internal to the operational amplifier. This protection circuitry is intended to remain inactive during normal circuit operation.

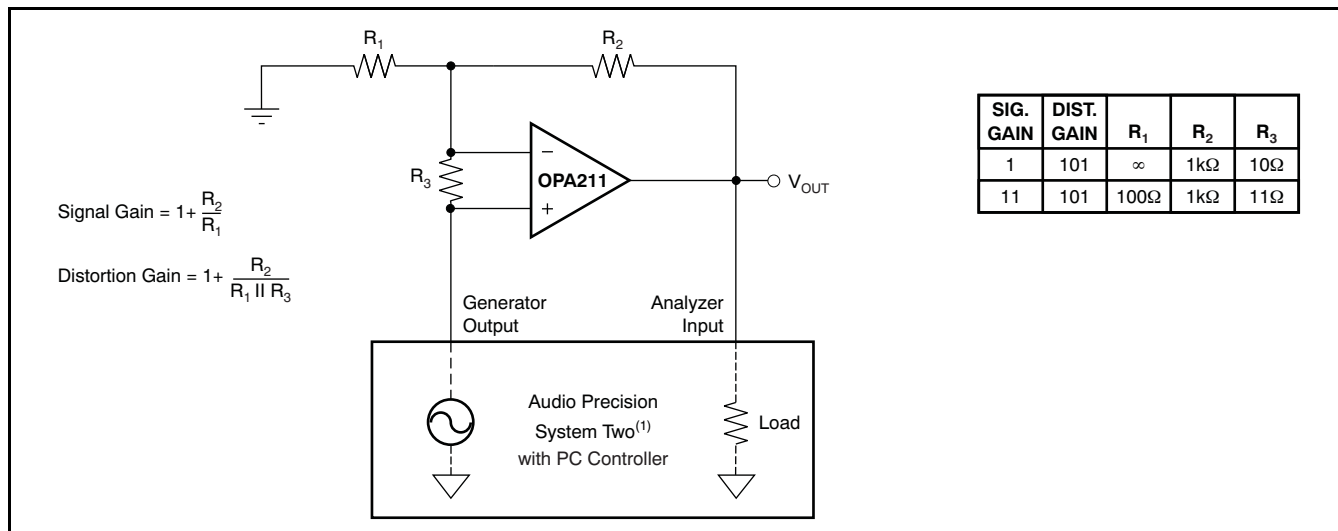

(1) For measurement bandwidth, see Figure 3, Figure 4, and Figure 5.

Figure 48. Distortion Test Circuit

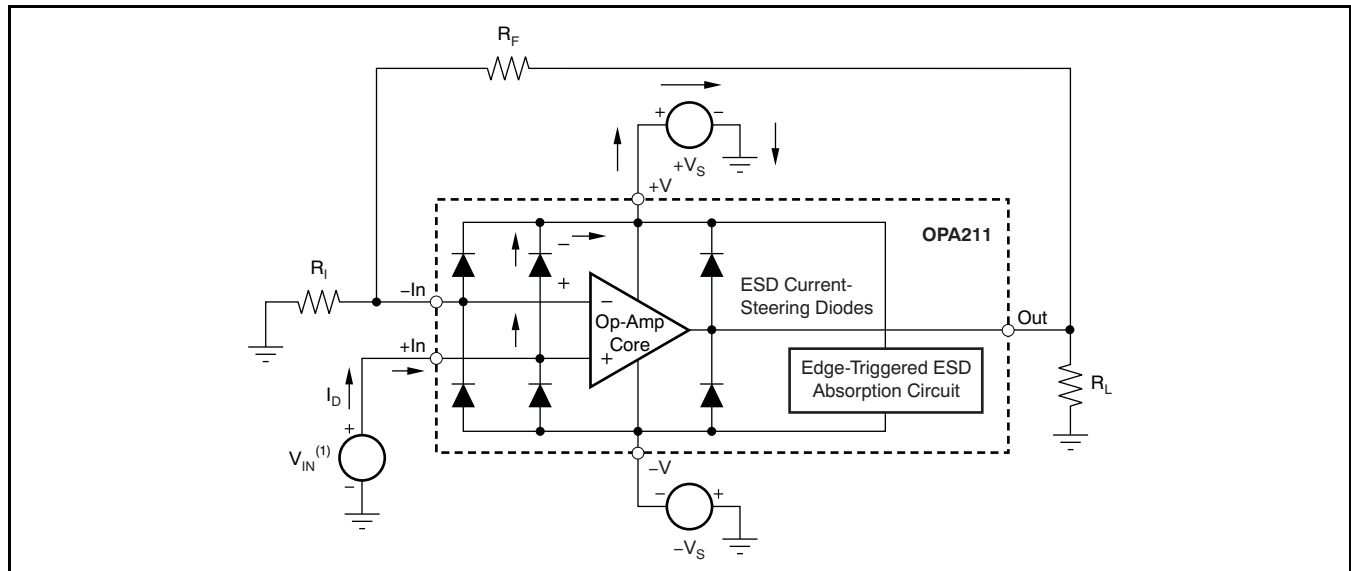

(1) $V_{IN} = +V_S + 500\text{mV}$.

Figure 49. Equivalent Internal ESD Circuitry and Its Relation to a Typical Circuit Application

An ESD event produces a short duration, high-voltage pulse that is transformed into a short duration, high-current pulse as it discharges through a semiconductor device. The ESD protection circuits are designed to provide a current path around the operational amplifier core to prevent it from being damaged. The energy absorbed by the protection circuitry is then dissipated as heat.

When an ESD voltage develops across two or more of the amplifier device pins, current flows through one or more of the steering diodes. Depending on the path that the current takes, the absorption device may activate. The absorption device has a trigger, or threshold voltage, that is above the normal operating voltage of the OPA211 but below the device breakdown voltage level. Once this threshold is exceeded, the absorption device quickly activates and clamps the voltage across the supply rails to a safe level.

When the operational amplifier connects into a circuit such as that illustrated in Figure 49, the ESD protection components are intended to remain inactive and not become involved in the application circuit operation. However, circumstances may arise where an applied voltage exceeds the operating voltage range of a given pin. Should this condition occur, there is a risk that some of the internal ESD protection circuits may be biased on, and conduct current. Any such current flow occurs through steering diode paths and rarely involves the absorption device.

Figure 49 depicts a specific example where the input voltage, V_{IN} , exceeds the positive supply voltage ($+V_S$) by 500mV or more. Much of what happens in the circuit depends on the supply characteristics. If $+V_S$ can sink the current, one of the upper input steering diodes conducts and directs current to $+V_S$. Excessively high current levels can flow with increasingly higher V_{IN} . As a result, the datasheet specifications recommend that applications limit the input current to 10mA.

If the supply is not capable of sinking the current, V_{IN} may begin sourcing current to the operational amplifier, and then take over as the source of positive supply voltage. The danger in this case is that the voltage can rise to levels that exceed the operational amplifier absolute maximum ratings. In extreme but rare cases, the absorption device triggers on while $+V_S$ and $-V_S$ are applied. If this event happens, a direct current path is established between the $+V_S$ and $-V_S$ supplies. The power dissipation of the absorption device is quickly exceeded, and the extreme internal heating destroys the operational amplifier.

Another common question involves what happens to the amplifier if an input signal is applied to the input while the power supplies $+V_S$ and/or $-V_S$ are at 0V. Again, it depends on the supply characteristic while at 0V, or at a level below the input signal amplitude. If the supplies appear as high impedance, then the operational amplifier supply current may be supplied by the input source via the current steering diodes. This state is not a normal bias condition; the amplifier

most likely will not operate normally. If the supplies are low impedance, then the current through the steering diodes can become quite high. The current level depends on the ability of the input source to deliver current, and any resistance in the input path.

THERMAL CONSIDERATIONS

A primary issue with all semiconductor devices is junction temperature (T_J). The most obvious consideration is assuring that T_J never exceeds the absolute maximum rating specified for the device. However, addressing device thermal dissipation has benefits beyond protecting the device from damage. Even modest increases in junction temperature can decrease op amp performance, and temperature-related errors can accumulate. Understanding the power generated by the device within the specific application and assessing the thermal effects on the error tolerance lead to a better understanding of system performance and thermal-dissipation needs. For dual-channel products, the worst-case power resulting from both channels must be determined. Products with a thermal pad (DFN and PowerPAD devices) provide the best thermal conduction away from the junction; see the *Thermal Resistance from Junction to Pad* parameter (θ_{JP}) in the [Electrical Characteristics](#) section. The use of packages with a thermal pad improves thermal dissipation. The device achieves its optimal performance through careful board and system design that considers characteristics such as board thickness, metal layers, component spacing, airflow, and board orientation. Refer to these application notes (available for download at www.ti.com) for additional details: [SZZA017A](#), [SCBA017](#), and [SPRA953A](#). For unusual loads and signals, see [SBOA022](#).

DFN PACKAGE

The OPA211 is offered in an DFN-8 package (also known as SON). The DFN package is a QFN package with lead contacts on only two sides of the bottom of the package. This leadless package maximizes board space and enhances thermal and electrical characteristics through an exposed pad.

DFN packages are physically small, and have a smaller routing area, improved thermal performance, and improved electrical parasitics. Additionally, the absence of external leads eliminates bent-lead issues.

The DFN package can be easily mounted using standard printed circuit board (PCB) assembly techniques. See Application Note *QFN/SON PCB Attachment* ([SLUA271](#)) and Application Report *Quad Flatpack No-Lead Logic Packages* ([SCBA017](#)), both available for download at www.ti.com.

The exposed leadframe die pad on the bottom of the package must be connected to V-. Soldering the thermal pad improves heat dissipation and enables specified device performance.

DFN LAYOUT GUIDELINES

The exposed leadframe die pad on the DFN package should be soldered to a thermal pad on the PCB. A mechanical drawing showing an example layout is attached at the end of this data sheet. Refinements to this layout may be necessary based on assembly process requirements. Mechanical drawings located at the end of this data sheet list the physical dimensions for the package and pad. The five holes in the landing pattern are optional, and are intended for use with thermal vias that connect the leadframe die pad to the heatsink area on the PCB.

Soldering the exposed pad significantly improves board-level reliability during temperature cycling, key push, package shear, and similar board-level tests. Even with applications that have low-power dissipation, the exposed pad must be soldered to the PCB to provide structural integrity and long-term reliability.

GENERAL POWERPAD DESIGN CONSIDERATIONS

The OPA2211 is available in a thermally-enhanced SO-8 PowerPAD package. This package is constructed using a downset leadframe upon which the die is mounted, as [Figure 50\(a\)](#) and [Figure 50\(b\)](#) illustrate. This arrangement results in the lead frame being exposed as a thermal pad on the underside of the package, as shown in [Figure 50\(c\)](#). This thermal pad has direct thermal contact with the die; thus, excellent thermal performance is achieved by providing a good thermal path away from the thermal pad.

The PowerPAD package allows for both assembly and thermal management in one manufacturing operation. During the surface-mount solder operation (when the leads are being soldered), the thermal pad must be soldered to a copper area underneath the package. Through the use of thermal paths within this copper area, heat can be conducted away from the package into either a ground plane or other heat-dissipating device. Soldering the PowerPAD to the printed circuit board (PCB) is always required, even with applications that have low power dissipation. This technique provides the necessary thermal and mechanical connection between the lead frame die pad and the PCB.

The PowerPAD must be connected to the most negative supply voltage on the device (V₋).

1. Prepare the PCB with a top-side etch pattern. There should be etching for the leads as well as etch for the thermal pad.
2. Place recommended holes in the area of the thermal pad. Ideal thermal land size and thermal via patterns for the SO-8 DDA package can be seen in the technical brief, *PowerPAD Thermally-Enhanced Package (SLMA002)*, available for download at www.ti.com. These holes should be 13 mils (0,33mm) in diameter. Keep them small, so that solder wicking through the holes is not a problem during reflow. An

example thermal land pattern mechanical drawing is attached to the end of this data sheet.

3. Additional vias may be placed anywhere along the thermal plane outside of the thermal pad area to help dissipate the heat generated by the OPA2211 SO-8. These additional vias may be larger than the 13-mil diameter vias directly under the thermal pad. They can be larger because they are not in the thermal pad area to be soldered; thus, wicking is not a problem.
4. Connect all holes to the internal plane that is at the same voltage potential as the V₋ pin.
5. When connecting these holes to the internal plane, do not use the typical web or spoke via connection methodology. Web connections have a high thermal resistance connection that is useful for slowing the heat transfer during soldering operations. This configuration makes the soldering of vias that have plane connections easier. In this application, however, low thermal resistance is desired for the most efficient heat transfer. Therefore, the holes under the OPA2211 PowerPAD package should make their connection to the internal plane with a complete connection around the entire circumference of the plated-through hole.
6. The top-side solder mask should leave the terminals of the package and the thermal pad area with its six holes exposed. The bottom-side solder mask should cover the holes of the thermal pad area. This masking prevents solder from being pulled away from the thermal pad area during the reflow process.
7. Apply solder paste to the exposed thermal pad area and all of the IC terminals.
8. With these preparatory steps in place, simply place the OPA2211 SO-8 IC in position and run the chip through the solder reflow operation as any standard surface-mount component. This preparation results in a properly installed part.

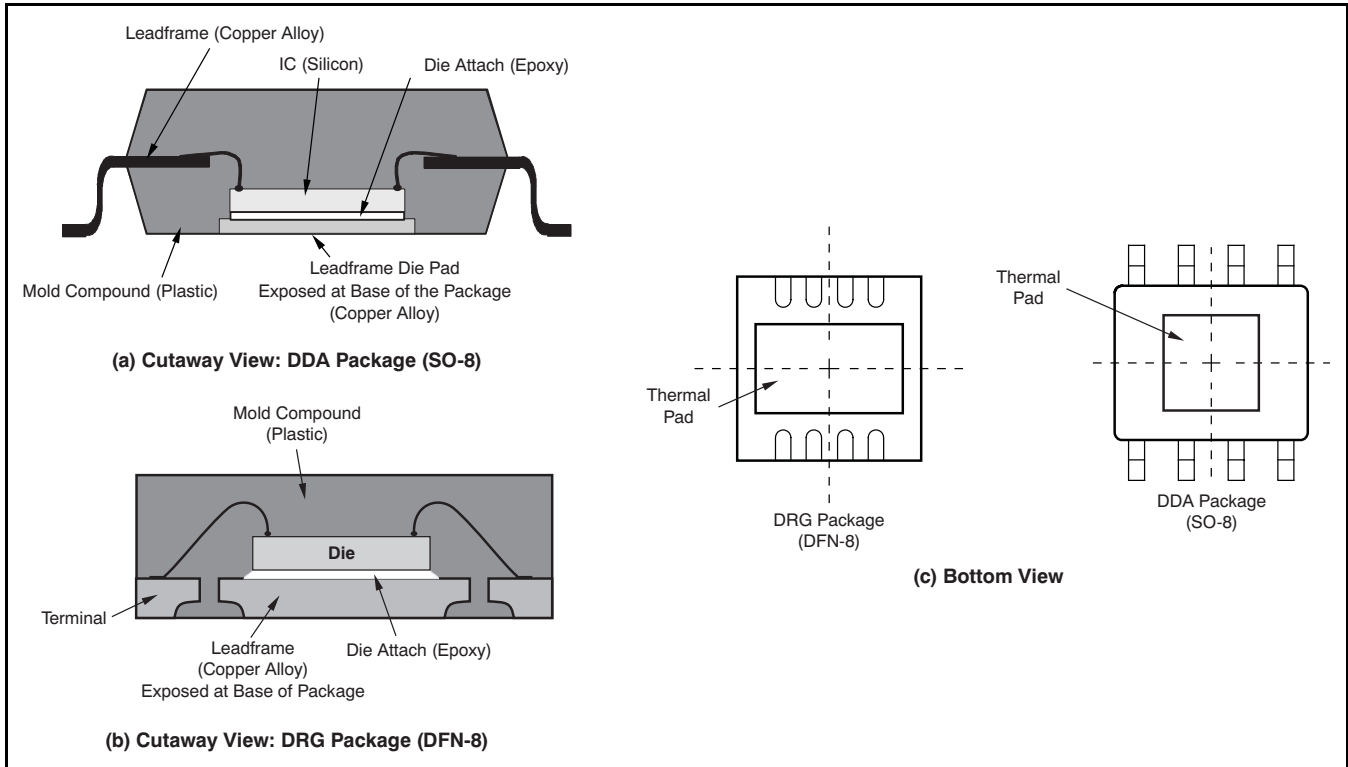

Figure 50. Views of Thermally-Enhanced SO-8 and DFN-8 Packages

REVISION HISTORY

NOTE: Page numbers for previous revisions may differ from page numbers in the current version.

Changes from Revision F (November, 2008) to Revision G	Page
• Changed orderable status of OPA2211 device packages to <i>released</i> from <i>product preview</i> throughout document	2
• Revised description of NC pin	3
• Added <i>Input Offset Voltage</i> , <i>Input Bias Current</i> , <i>Open-Loop Gain</i> , and <i>Thermal Resistance</i> specifications to indicate performance for OPA2211 device	4
• Corrected Temperature Range parametric symbol location for specified and operating range specifications	5
• Added footnote (4) to <i>Electrical Characteristics</i> table	5
• Updated Figure 3	6
• Added information to legend in Figure 4	6
• Added Figure 5	6
• Added Figure 6	6
• Changed title of Figure 12 for clarification	7
• Corrected circuit drawing in Figure 26	10
• Corrected circuit drawing in Figure 27	10
• Changed first paragraph of <i>Total Harmonic Distortion Measurements</i> section	17
• Updated Figure 48	17
• Added <i>Thermal Considerations</i> section	19
• Added <i>General PowerPAD Design Considerations</i> section	20

PACKAGING INFORMATION

Orderable Device	Status ⁽¹⁾	Package Type	Package Drawing	Pins	Package Qty	Eco Plan ⁽²⁾	Lead/ Ball Finish	MSL Peak Temp ⁽³⁾	Samples (Requires Login)
OPA211AID	ACTIVE	SOIC	D	8	75	Green (RoHS & no Sb/Br)	Call TI	Level-2-260C-1 YEAR	
OPA211AIDG4	ACTIVE	SOIC	D	8	75	Green (RoHS & no Sb/Br)	Call TI	Level-2-260C-1 YEAR	
OPA211AIDGKR	ACTIVE	VSSOP	DGK	8	2500	Green (RoHS & no Sb/Br)	Call TI	Level-2-260C-1 YEAR	
OPA211AIDGKRG4	ACTIVE	VSSOP	DGK	8	2500	Green (RoHS & no Sb/Br)	Call TI	Level-2-260C-1 YEAR	
OPA211AIDGKT	ACTIVE	VSSOP	DGK	8	250	Green (RoHS & no Sb/Br)	Call TI	Level-2-260C-1 YEAR	
OPA211AIDGKTG4	ACTIVE	VSSOP	DGK	8	250	Green (RoHS & no Sb/Br)	Call TI	Level-2-260C-1 YEAR	
OPA211AIDR	ACTIVE	SOIC	D	8	2500	Green (RoHS & no Sb/Br)	Call TI	Level-2-260C-1 YEAR	
OPA211AIDRG4	ACTIVE	SOIC	D	8	2500	Green (RoHS & no Sb/Br)	Call TI	Level-2-260C-1 YEAR	
OPA211AIDRGR	ACTIVE	SON	DRG	8	1000	Green (RoHS & no Sb/Br)	Call TI	Level-2-260C-1 YEAR	
OPA211AIDRGRG4	ACTIVE	SON	DRG	8	1000	Green (RoHS & no Sb/Br)	Call TI	Level-2-260C-1 YEAR	
OPA211AIDRGT	ACTIVE	SON	DRG	8	250	Green (RoHS & no Sb/Br)	Call TI	Level-2-260C-1 YEAR	
OPA211AIDRGTG4	ACTIVE	SON	DRG	8	250	Green (RoHS & no Sb/Br)	Call TI	Level-2-260C-1 YEAR	
OPA211ID	ACTIVE	SOIC	D	8	75	Green (RoHS & no Sb/Br)	Call TI	Level-2-260C-1 YEAR	
OPA211IDGKR	ACTIVE	VSSOP	DGK	8	2500	Green (RoHS & no Sb/Br)	Call TI	Level-2-260C-1 YEAR	
OPA211IDGKT	ACTIVE	VSSOP	DGK	8	250	Green (RoHS & no Sb/Br)	Call TI	Level-2-260C-1 YEAR	
OPA211IDR	ACTIVE	SOIC	D	8	2500	Green (RoHS & no Sb/Br)	Call TI	Level-2-260C-1 YEAR	
OPA211IDRGR	ACTIVE	SON	DRG	8	3000	Green (RoHS & no Sb/Br)	Call TI	Level-2-260C-1 YEAR	

Orderable Device	Status ⁽¹⁾	Package Type	Package Drawing	Pins	Package Qty	Eco Plan ⁽²⁾	Lead/ Ball Finish	MSL Peak Temp ⁽³⁾	Samples (Requires Login)
OPA211IDRGT	ACTIVE	SON	DRG	8	250	Green (RoHS & no Sb/Br)	Call TI	Level-2-260C-1 YEAR	
OPA2211AIDDA	ACTIVE	SO PowerPAD	DDA	8	75	Green (RoHS & no Sb/Br)	CU NIPDAU	Level-1-260C-UNLIM	
OPA2211AIDDAR	ACTIVE	SO PowerPAD	DDA	8	2500	Green (RoHS & no Sb/Br)	CU NIPDAU	Level-1-260C-UNLIM	
OPA2211AIDRGR	ACTIVE	SON	DRG	8	3000	Green (RoHS & no Sb/Br)	CU NIPDAU	Level-2-260C-1 YEAR	
OPA2211AIDRGT	ACTIVE	SON	DRG	8	250	Green (RoHS & no Sb/Br)	CU NIPDAU	Level-2-260C-1 YEAR	

⁽¹⁾ The marketing status values are defined as follows:

ACTIVE: Product device recommended for new designs.

LIFEBUY: TI has announced that the device will be discontinued, and a lifetime-buy period is in effect.

NRND: Not recommended for new designs. Device is in production to support existing customers, but TI does not recommend using this part in a new design.

PREVIEW: Device has been announced but is not in production. Samples may or may not be available.

OBSOLETE: TI has discontinued the production of the device.

⁽²⁾ Eco Plan - The planned eco-friendly classification: Pb-Free (RoHS), Pb-Free (RoHS Exempt), or Green (RoHS & no Sb/Br) - please check <http://www.ti.com/productcontent> for the latest availability information and additional product content details.

TBD: The Pb-Free/Green conversion plan has not been defined.

Pb-Free (RoHS): TI's terms "Lead-Free" or "Pb-Free" mean semiconductor products that are compatible with the current RoHS requirements for all 6 substances, including the requirement that lead not exceed 0.1% by weight in homogeneous materials. Where designed to be soldered at high temperatures, TI Pb-Free products are suitable for use in specified lead-free processes.

Pb-Free (RoHS Exempt): This component has a RoHS exemption for either 1) lead-based flip-chip solder bumps used between the die and package, or 2) lead-based die adhesive used between the die and leadframe. The component is otherwise considered Pb-Free (RoHS compatible) as defined above.

Green (RoHS & no Sb/Br): TI defines "Green" to mean Pb-Free (RoHS compatible), and free of Bromine (Br) and Antimony (Sb) based flame retardants (Br or Sb do not exceed 0.1% by weight in homogeneous material)

⁽³⁾ MSL, Peak Temp. -- The Moisture Sensitivity Level rating according to the JEDEC industry standard classifications, and peak solder temperature.

Important Information and Disclaimer: The information provided on this page represents TI's knowledge and belief as of the date that it is provided. TI bases its knowledge and belief on information provided by third parties, and makes no representation or warranty as to the accuracy of such information. Efforts are underway to better integrate information from third parties. TI has taken and continues to take reasonable steps to provide representative and accurate information but may not have conducted destructive testing or chemical analysis on incoming materials and chemicals. TI and TI suppliers consider certain information to be proprietary, and thus CAS numbers and other limited information may not be available for release.

In no event shall TI's liability arising out of such information exceed the total purchase price of the TI part(s) at issue in this document sold by TI to Customer on an annual basis.

OTHER QUALIFIED VERSIONS OF OPA211 :

- Enhanced Product: [OPA211-EP](#)

NOTE: Qualified Version Definitions:

- Enhanced Product - Supports Defense, Aerospace and Medical Applications

TAPE AND REEL INFORMATION
REEL DIMENSIONS

TAPE DIMENSIONS

A0	Dimension designed to accommodate the component width
B0	Dimension designed to accommodate the component length
K0	Dimension designed to accommodate the component thickness
W	Overall width of the carrier tape
P1	Pitch between successive cavity centers

TAPE AND REEL INFORMATION

*All dimensions are nominal

Device	Package Type	Package Drawing	Pins	SPQ	Reel Diameter (mm)	Reel Width W1 (mm)	A0 (mm)	B0 (mm)	K0 (mm)	P1 (mm)	W (mm)	Pin1 Quadrant
OPA2211AIDDAR	SO Power PAD	DDA	8	2500	330.0	12.4	6.4	5.2	2.1	8.0	12.0	Q1
OPA2211AIDRGR	SON	DRG	8	3000	330.0	12.4	3.3	3.3	1.1	8.0	12.0	Q2
OPA2211AIDRGT	SON	DRG	8	250	180.0	12.4	3.3	3.3	1.1	8.0	12.0	Q2

TAPE AND REEL BOX DIMENSIONS

*All dimensions are nominal

Device	Package Type	Package Drawing	Pins	SPQ	Length (mm)	Width (mm)	Height (mm)
OPA2211AIDDAR	SO PowerPAD	DDA	8	2500	367.0	367.0	35.0
OPA2211AIDRGR	SON	DRG	8	3000	367.0	367.0	35.0
OPA2211AIDRGT	SON	DRG	8	250	210.0	185.0	35.0

DGK (S-PDSO-G8)

PLASTIC SMALL-OUTLINE PACKAGE



- NOTES:
- A. All linear dimensions are in millimeters.
 - B. This drawing is subject to change without notice.
 - C. Body length does not include mold flash, protrusions, or gate burrs. Mold flash, protrusions, or gate burrs shall not exceed 0.15 per end.
 - D. Body width does not include interlead flash. Interlead flash shall not exceed 0.50 per side.
 - E. Falls within JEDEC MO-187 variation AA, except interlead flash.

DDA (R-PDSO-G8)

PowerPAD™ PLASTIC SMALL-OUTLINE

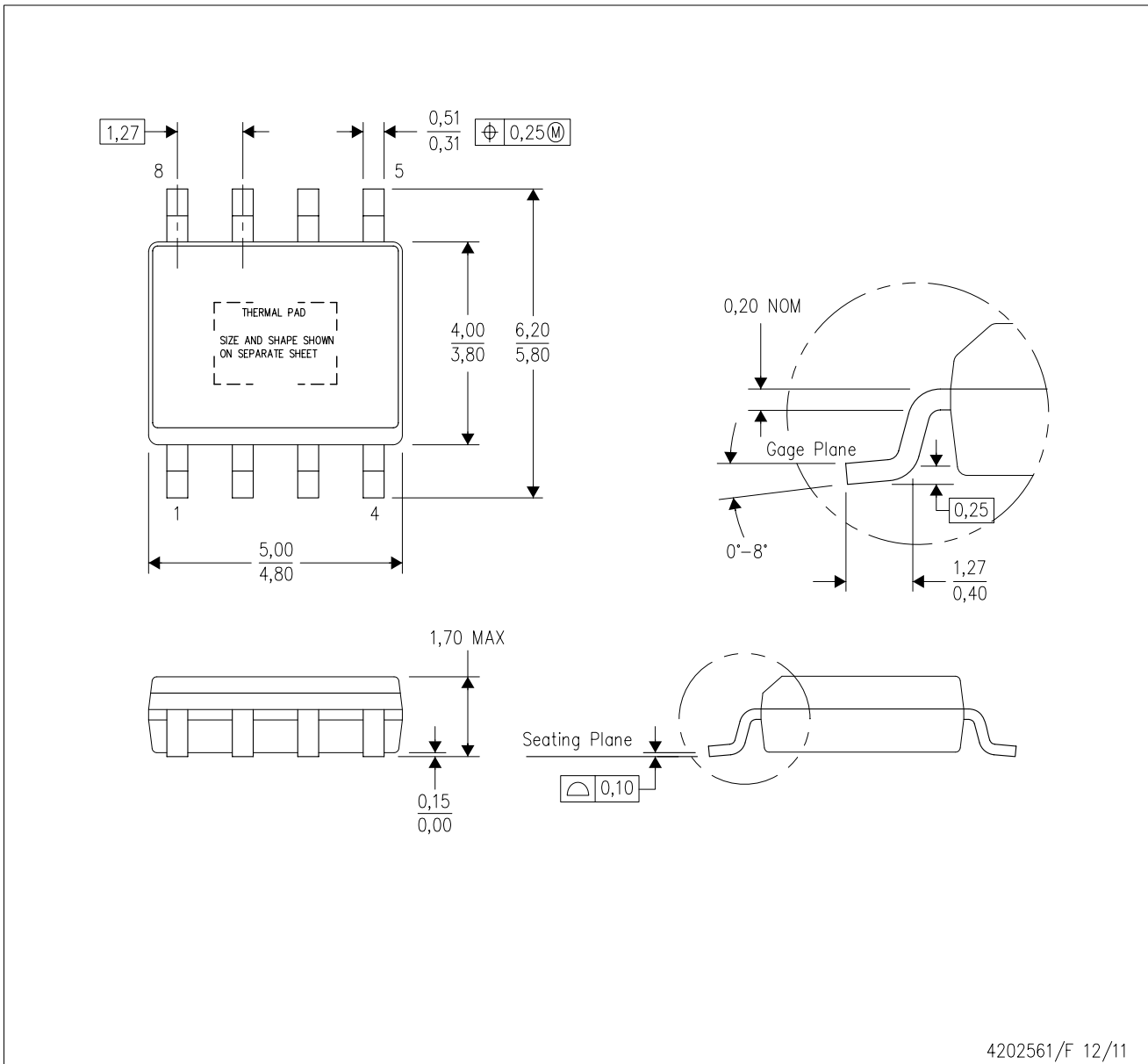

4202561/F 12/11

- NOTES:
- A. All linear dimensions are in millimeters. Dimensioning and tolerancing per ASME Y14.5-1994.
 - B. This drawing is subject to change without notice.
 - C. Body dimensions do not include mold flash or protrusion not to exceed 0,15.
 - D. This package is designed to be soldered to a thermal pad on the board. Refer to Technical Brief, PowerPad Thermally Enhanced Package, Texas Instruments Literature No. SLMA002 for information regarding recommended board layout. This document is available at www.ti.com <<http://www.ti.com>>.
 - E. See the additional figure in the Product Data Sheet for details regarding the exposed thermal pad features and dimensions.
 - F. This package complies to JEDEC MS-012 variation BA

PowerPAD is a trademark of Texas Instruments.

DDA (R-PDSO-G8)

PowerPAD™ PLASTIC SMALL OUTLINE

THERMAL INFORMATION

This PowerPAD™ package incorporates an exposed thermal pad that is designed to be attached to a printed circuit board (PCB). The thermal pad must be soldered directly to the PCB. After soldering, the PCB can be used as a heatsink. In addition, through the use of thermal vias, the thermal pad can be attached directly to the appropriate copper plane shown in the electrical schematic for the device, or alternatively, can be attached to a special heatsink structure designed into the PCB. This design optimizes the heat transfer from the integrated circuit (IC).

For additional information on the PowerPAD package and how to take advantage of its heat dissipating abilities, refer to Technical Brief, PowerPAD Thermally Enhanced Package, Texas Instruments Literature No. SLMA002 and Application Brief, PowerPAD Made Easy, Texas Instruments Literature No. SLMA004. Both documents are available at www.ti.com.

The exposed thermal pad dimensions for this package are shown in the following illustration.

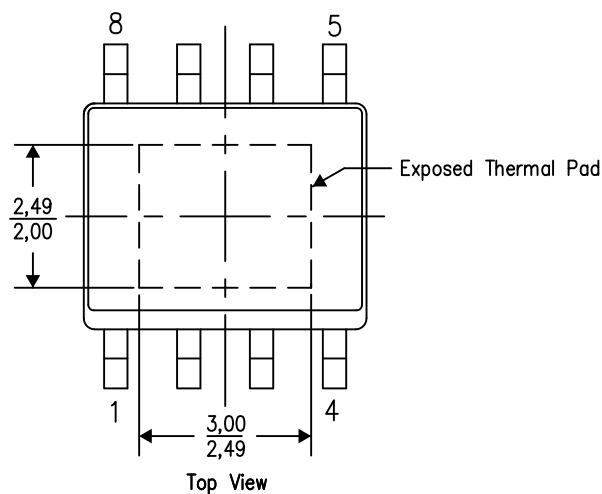

Exposed Thermal Pad Dimensions

4206322-3/L 05/12

NOTE: A. All linear dimensions are in millimeters

PowerPAD is a trademark of Texas Instruments

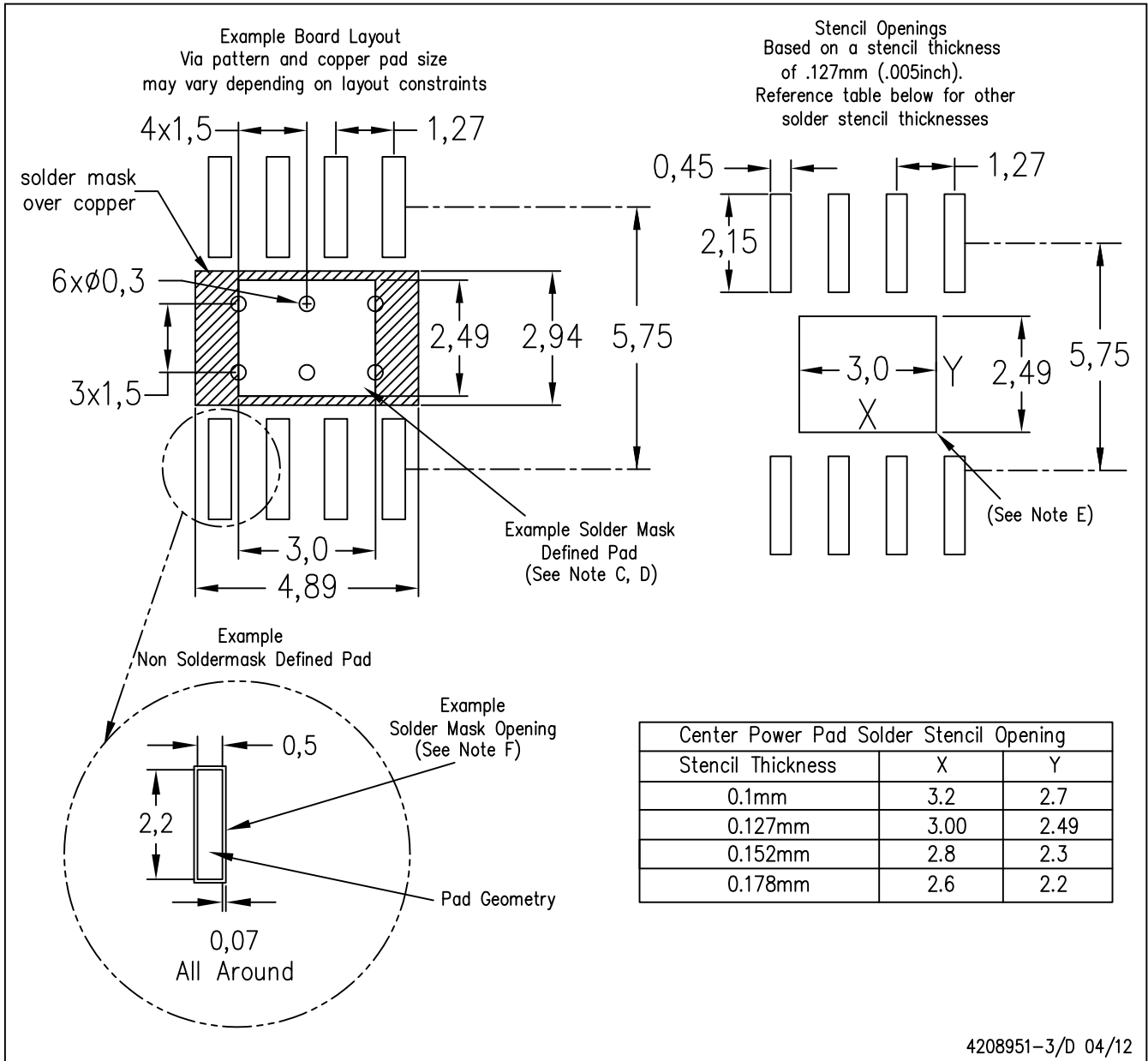

- NOTES:
- A. All linear dimensions are in millimeters.
 - B. This drawing is subject to change without notice.
 - C. Customers should place a note on the circuit board fabrication drawing not to alter the center solder mask defined pad.
 - D. This package is designed to be soldered to a thermal pad on the board. Refer to Technical Brief, PowerPad Thermally Enhanced Package, Texas Instruments Literature No. SLMA002, SLMA004, and also the Product Data Sheets for specific thermal information, via requirements, and recommended board layout. These documents are available at www.ti.com <<http://www.ti.com>>. Publication IPC-7351 is recommended for alternate designs.
 - E. Laser cutting apertures with trapezoidal walls and also rounding corners will offer better paste release. Customers should contact their board assembly site for stencil design recommendations. Example stencil design based on a 50% volumetric metal load solder paste. Refer to IPC-7525 for other stencil recommendations.
 - F. Customers should contact their board fabrication site for solder mask tolerances between and around signal pads.

PowerPAD is a trademark of Texas Instruments.

DRG (S-PWSON-N8)

PLASTIC SMALL OUTLINE NO-LEAD

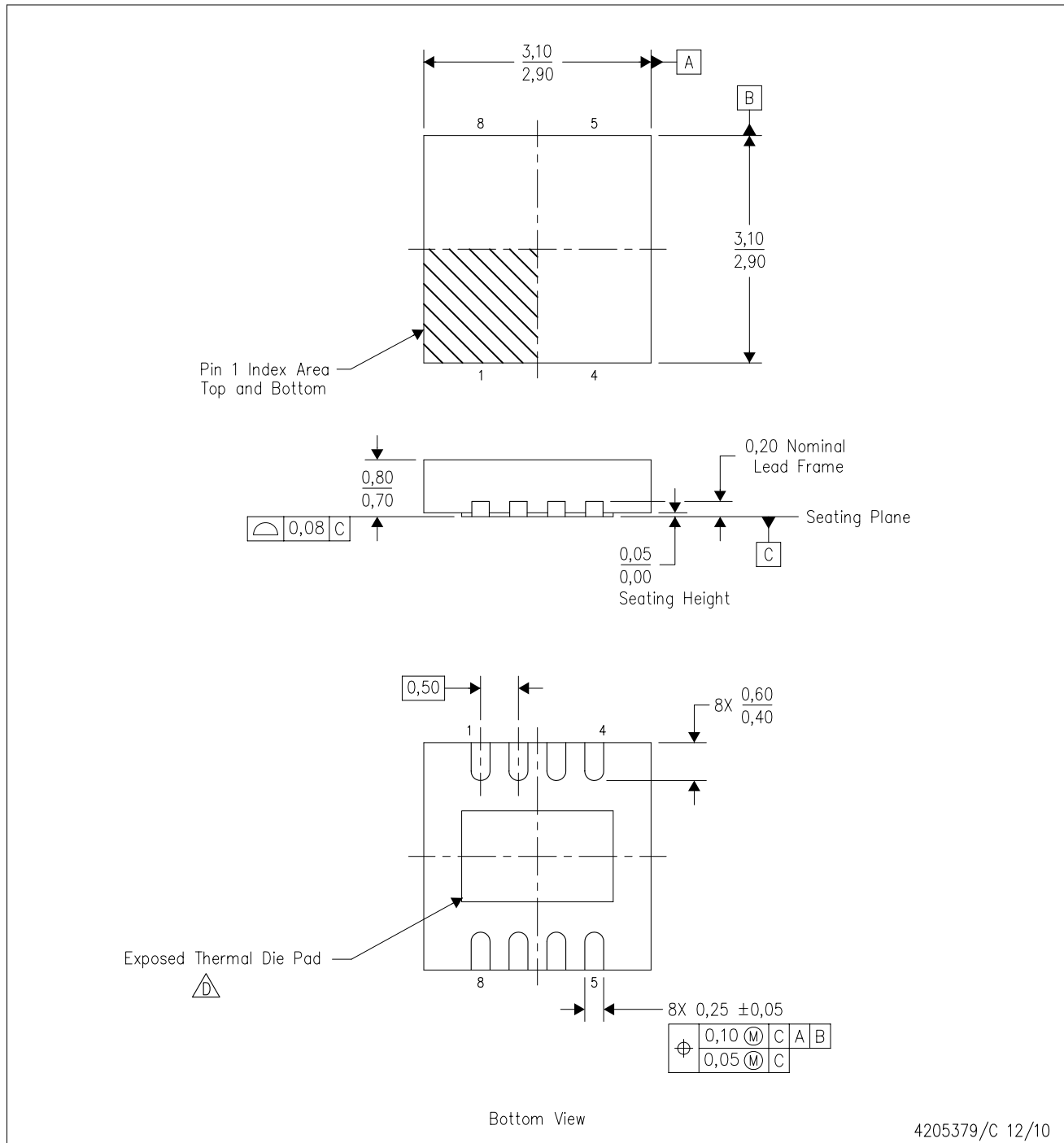

4205379/C 12/10

- NOTES:
- A. All linear dimensions are in millimeters. Dimensioning and tolerancing per ASME Y14.5M-1994.
 - B. This drawing is subject to change without notice.
 - C. SON (Small Outline No-Lead) package configuration.
 - D. The package thermal pad must be soldered to the board for thermal and mechanical performance. See the Product Data Sheet for details regarding the exposed thermal pad dimensions.
 - E. JEDEC MO-229 package registration pending.

THERMAL PAD MECHANICAL DATA

DRG (S-PWSON-N8)

PLASTIC SMALL OUTLINE NO-LEAD

THERMAL INFORMATION

This package incorporates an exposed thermal pad that is designed to be attached directly to an external heatsink. The thermal pad must be soldered directly to the printed circuit board (PCB). After soldering, the PCB can be used as a heatsink. In addition, through the use of thermal vias, the thermal pad can be attached directly to the appropriate copper plane shown in the electrical schematic for the device, or alternatively, can be attached to a special heatsink structure designed into the PCB. This design optimizes the heat transfer from the integrated circuit (IC).

For information on the Quad Flatpack No-Lead (QFN) package and its advantages, refer to Application Report, QFN/SON PCB Attachment, Texas Instruments Literature No. SLUA271. This document is available at www.ti.com.

The exposed thermal pad dimensions for this package are shown in the following illustration.

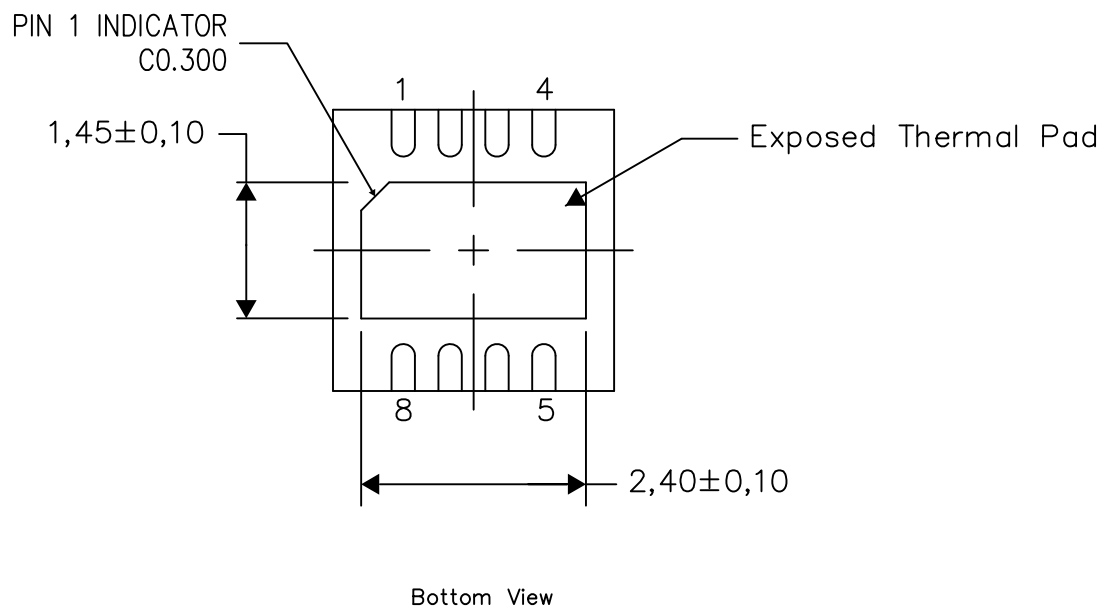

Exposed Thermal Pad Dimensions

4206881-3/G 04/12

NOTE: All linear dimensions are in millimeters

DRG (S-PWSON-N8)

PLASTIC SMALL OUTLINE NO-LEAD

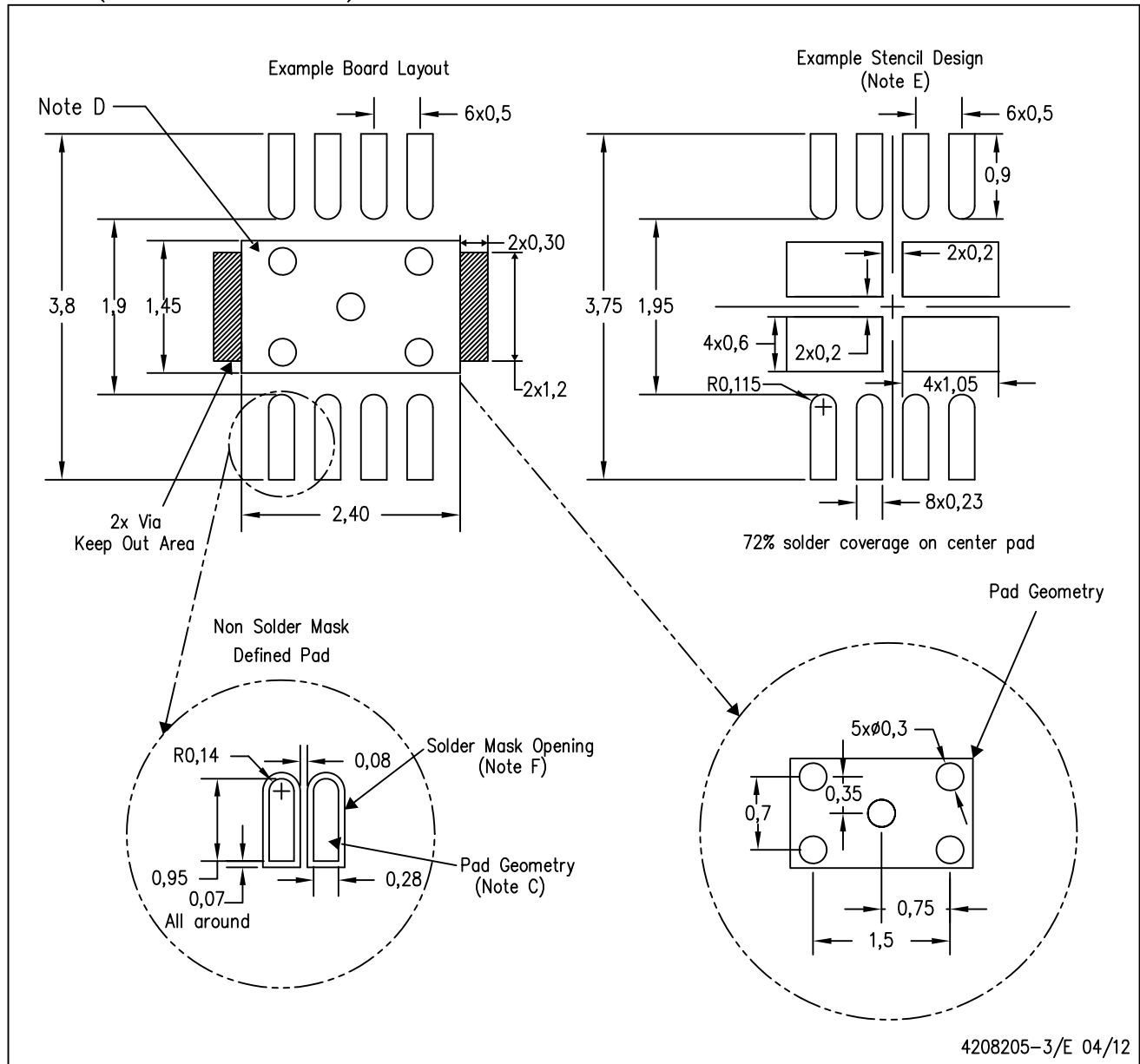

- NOTES:
- All linear dimensions are in millimeters.
 - This drawing is subject to change without notice.
 - Publication IPC-SM-782 is recommended for alternate designs.
 - This package is designed to be soldered to a thermal pad on the board. Refer to Application Note, Quad Flat-Pack Packages, Texas Instruments Literature No. SLUA271, and also the Product Data Sheets for specific thermal information, via requirements, and recommended board layout. These documents are available at www.ti.com <<http://www.ti.com>>.
 - Laser cutting apertures with trapezoidal walls and also rounding corners will offer better paste release. Customers should contact their board assembly site for stencil design recommendations. Refer to IPC 7525 for stencil design considerations.
 - Customers should contact their board fabrication site for minimum solder mask web tolerances between signal pads.

IMPORTANT NOTICE

Texas Instruments Incorporated and its subsidiaries (TI) reserve the right to make corrections, enhancements, improvements and other changes to its semiconductor products and services per JESD46, latest issue, and to discontinue any product or service per JESD48, latest issue. Buyers should obtain the latest relevant information before placing orders and should verify that such information is current and complete. All semiconductor products (also referred to herein as "components") are sold subject to TI's terms and conditions of sale supplied at the time of order acknowledgment.

TI warrants performance of its components to the specifications applicable at the time of sale, in accordance with the warranty in TI's terms and conditions of sale of semiconductor products. Testing and other quality control techniques are used to the extent TI deems necessary to support this warranty. Except where mandated by applicable law, testing of all parameters of each component is not necessarily performed.

TI assumes no liability for applications assistance or the design of Buyers' products. Buyers are responsible for their products and applications using TI components. To minimize the risks associated with Buyers' products and applications, Buyers should provide adequate design and operating safeguards.

TI does not warrant or represent that any license, either express or implied, is granted under any patent right, copyright, mask work right, or other intellectual property right relating to any combination, machine, or process in which TI components or services are used. Information published by TI regarding third-party products or services does not constitute a license to use such products or services or a warranty or endorsement thereof. Use of such information may require a license from a third party under the patents or other intellectual property of the third party, or a license from TI under the patents or other intellectual property of TI.

Reproduction of significant portions of TI information in TI data books or data sheets is permissible only if reproduction is without alteration and is accompanied by all associated warranties, conditions, limitations, and notices. TI is not responsible or liable for such altered documentation. Information of third parties may be subject to additional restrictions.

Resale of TI components or services with statements different from or beyond the parameters stated by TI for that component or service voids all express and any implied warranties for the associated TI component or service and is an unfair and deceptive business practice. TI is not responsible or liable for any such statements.

Buyer acknowledges and agrees that it is solely responsible for compliance with all legal, regulatory and safety-related requirements concerning its products, and any use of TI components in its applications, notwithstanding any applications-related information or support that may be provided by TI. Buyer represents and agrees that it has all the necessary expertise to create and implement safeguards which anticipate dangerous consequences of failures, monitor failures and their consequences, lessen the likelihood of failures that might cause harm and take appropriate remedial actions. Buyer will fully indemnify TI and its representatives against any damages arising out of the use of any TI components in safety-critical applications.

In some cases, TI components may be promoted specifically to facilitate safety-related applications. With such components, TI's goal is to help enable customers to design and create their own end-product solutions that meet applicable functional safety standards and requirements. Nonetheless, such components are subject to these terms.

No TI components are authorized for use in FDA Class III (or similar life-critical medical equipment) unless authorized officers of the parties have executed a special agreement specifically governing such use.

Only those TI components which TI has specifically designated as military grade or "enhanced plastic" are designed and intended for use in military/aerospace applications or environments. Buyer acknowledges and agrees that any military or aerospace use of TI components which have **not** been so designated is solely at the Buyer's risk, and that Buyer is solely responsible for compliance with all legal and regulatory requirements in connection with such use.

TI has specifically designated certain components which meet ISO/TS16949 requirements, mainly for automotive use. Components which have not been so designated are neither designed nor intended for automotive use; and TI will not be responsible for any failure of such components to meet such requirements.

Products

Audio	www.ti.com/audio
Amplifiers	amplifier.ti.com
Data Converters	dataconverter.ti.com
DLP® Products	www.dlp.com
DSP	dsp.ti.com
Clocks and Timers	www.ti.com/clocks
Interface	interface.ti.com
Logic	logic.ti.com
Power Mgmt	power.ti.com
Microcontrollers	microcontroller.ti.com
RFID	www.ti-rfid.com
OMAP Applications Processors	www.ti.com/omap
Wireless Connectivity	www.ti.com/wirelessconnectivity

Applications

Automotive and Transportation	www.ti.com/automotive
Communications and Telecom	www.ti.com/communications
Computers and Peripherals	www.ti.com/computers
Consumer Electronics	www.ti.com/consumer-apps
Energy and Lighting	www.ti.com/energy
Industrial	www.ti.com/industrial
Medical	www.ti.com/medical
Security	www.ti.com/security
Space, Avionics and Defense	www.ti.com/space-avionics-defense
Video and Imaging	www.ti.com/video

TI E2E Community

e2e.ti.com