

## 250-MHz, CMOS Transimpedance Amplifier (TIA) with Integrated Switch and Buffer

Check for Samples: [OPA1S2384](#), [OPA1S2385](#)

### FEATURES

- **Wide Bandwidth:** 250 MHz
- **High Slew Rate:** 150 V/ $\mu$ s
- **Rail-to-Rail Input/Output (I/O)**
- **Fast Settling**
- **Low Input Bias Current:** 3 pA
- **High Input Impedance:**  $10^{13} \Omega \parallel 2 \text{ pF}$
- **SPST Switch:**
  - **Low On-Resistance:** 7  $\Omega$
  - **Low Charge Injection:** 1 pC
  - **Low Leakage Current:** 10 pA
- **Flexible Configuration:**
  - **Transimpedance Gain**
  - **External Hold Capacitor**
  - **Post-Gain**
- **Single Supply:** +2.7 V to +5.5 V
- **Low Quiescent Current:** 9.8 mA
- **Small Package:** 3-mm  $\times$  3-mm SON-10

### APPLICATIONS

- **Communications:**
  - **Optical Networking:** EPON, GPON
  - **Signal Strength Monitors**
  - **Burst-Mode RSSI**
- **Photodiode Monitoring**
- **Fast Sample-and-Hold Circuits**
- **Charge Amplifiers**
- **High-Speed Integrators**

### DESCRIPTION

The OPA1S2384 and OPA1S2385 (OPA1S238x) combine high bandwidth, FET-input operational amplifiers with a fast SPST CMOS switch designed for applications that require the tracking and capturing of fast signals.

By providing a 250-MHz gain bandwidth product and rail-to-rail input/output swings in single-supply operation, the OPA1S238x is capable of wideband transimpedance gain and large output signal swing simultaneously. Low input bias current and voltage noise (6 nV/ $\sqrt{\text{Hz}}$ ) make it possible to amplify extremely low-level input signals for maximum signal-to-noise ratio.

The characteristics of the OPA1S238x make this device ideally suited for use as a wideband photodiode amplifier.

In addition, the CMOS switch and subsequent buffer amplifier allow the OPA1S238x to be easily configured as a fast sample-and-hold circuit. The external hold capacitor and post-gain options make the OPA1S238x easily adoptable to a wide range of speed and accuracy requirements. Note that the OPA1S2384 closes the internal switch with a logic-high signal, and the OPA1S2385 closes the internal switch with a logic-low signal.

The OPA1S238x are optimized for low-voltage operation from as low as +2.7 V up to +5.5 V. These devices are specified for a temperature range of  $-40^{\circ}\text{C}$  to  $+85^{\circ}\text{C}$ .

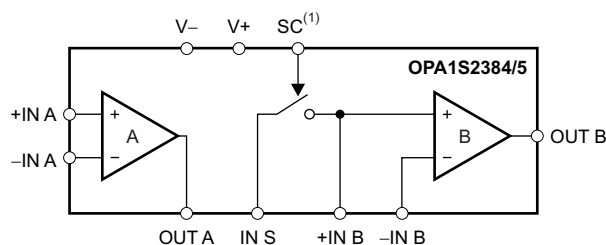

(1) Polarity of the switch depends on ordering code.



Please be aware that an important notice concerning availability, standard warranty, and use in critical applications of Texas Instruments semiconductor products and disclaimers thereto appears at the end of this data sheet.

All trademarks are the property of their respective owners.



This integrated circuit can be damaged by ESD. Texas Instruments recommends that all integrated circuits be handled with appropriate precautions. Failure to observe proper handling and installation procedures can cause damage.

ESD damage can range from subtle performance degradation to complete device failure. Precision integrated circuits may be more susceptible to damage because very small parametric changes could cause the device not to meet its published specifications.

### PACKAGE INFORMATION<sup>(1)</sup>

PRODUCT	PACKAGE-LEAD	PACKAGE DESIGNATOR	SPECIFIED TEMPERATURE RANGE	PACKAGE MARKING	ORDERING NUMBER	TRANSPORT MEDIA, QUANTITY
OPA1S2384 <sup>(2)</sup>	SON-10	DRC	–40°C to +85°C	OVAQ	OPA1S2384IDRCT	TBD
					OPA1S2384IDRCR	TBD
OPA1S2385	SON-10	DRC	–40°C to +85°C	OUZQ	OPA1S2385IDRCT	Tape and Reel, 250
					OPA1S2385IDRCR	Tape and Reel, 3000

(1) For the most current package and ordering information see the Package Option Addendum at the end of this document, or see the [INA230 product folder](#) at [www.ti.com](#).

(2) OPA1S2384 is product preview.

### ABSOLUTE MAXIMUM RATINGS<sup>(1)</sup>

Over operating free-air temperature range (unless otherwise noted).

		OPA1S238x	UNIT
Supply voltage, V+ to V–		6	V
Signal input terminals, op amp section	Voltage <sup>(2)</sup>	(V–) – 0.3 to (V+) + 0.3	V
	Current <sup>(2)</sup>	±10	mA
On-state switch current; V <sub>IN S</sub> , V <sub>+IN B</sub> = 0 to V+		±20	mA
Output (OUT A, OUT B) short-circuit current <sup>(3)</sup>		Continuous	
Digital input voltage range (SC pin)		–0.3 to +6	V
Digital input clamp current (SC pin)		–50	mA
Operating temperature, T <sub>A</sub>		–40 to +125	°C
Storage temperature, T <sub>stg</sub>		–65 to +150	°C
Junction temperature, T <sub>J</sub>		+150	°C
ESD Ratings	Human body model (HBM)	4000	V
	Charged-device model (CDM)	1000	V

(1) Stresses above these ratings may cause permanent damage. Exposure to absolute maximum conditions for extended periods may degrade device reliability. These are stress ratings only, and functional operation of the device at these or any other conditions beyond those specified is not implied.

(2) Input terminals are diode-clamped to the power-supply rails. Input signals that can swing more than 0.5 V beyond the supply rails should be current limited to 10 mA or less.

(3) Short-circuit to ground, one amplifier per package.

**ELECTRICAL CHARACTERISTICS:  $V_{SS} = +2.7\text{ V to }+5.5\text{ V}^{(1)}\text{ }^{(2)}$** 

At  $T_A = +25^\circ\text{C}$ ,  $R_L = 1\text{ k}\Omega$  connected to  $V_S / 2$ , and  $V_O = V_{CM} = V_S / 2$ , unless otherwise noted.

PARAMETER		CONDITIONS	OPA1S238x			UNIT
			MIN	TYP	MAX	
<b>OFFSET VOLTAGE</b>						
$V_{OS}$	Input offset voltage			2	8	mV
$\Delta V_{OS}/\Delta T$	Input offset voltage vs temperature	$T_A = -40^\circ\text{C to }+85^\circ\text{C}$		6		$\mu\text{V}/^\circ\text{C}$
PSRR	Input offset voltage vs power supply	$V_{CM} = V_S / 2 - 0.65\text{ V}$		0.2	0.8	mV/V
	Channel separation, dc	At $f = 5\text{ MHz}$		10		$\mu\text{V}/\text{V}$
<b>INPUT VOLTAGE RANGE</b>						
$V_{CM}$	Common-mode voltage range	No phase reversal, rail-to-rail input	$(V_-) - 0.1$		$(V_+) + 0.1$	V
CMRR	Common-mode rejection ratio	$V_S = 5.5\text{ V}, (V_-) - 0.1\text{ V} < V_{CM} < (V_+) - 2\text{ V}$	66	80		dB
		$V_S = 3.3\text{ V}, (V_-) - 0.1\text{ V} < V_{CM} < (V_+) + 0.1\text{ V}$	50	68		dB
<b>INPUT BIAS CURRENT</b>						
$I_B$	Input bias current			$\pm 3$	$\pm 50$	pA
$I_{OS}$	Input offset current			$\pm 1$	$\pm 50$	pA
<b>NOISE</b>						
	Input noise voltage density	$f = 1\text{ MHz}$		6		$\text{nV}/\sqrt{\text{Hz}}$
		$f = 10\text{ MHz}$		26		$\text{nV}/\sqrt{\text{Hz}}$
	Input current noise density	$f = 1\text{ MHz}$		50		$\text{fA}/\sqrt{\text{Hz}}$
<b>INPUT CAPACITANCE</b>						
	Differential			2		pF
	Common-mode			2		pF
<b>OPEN-LOOP GAIN</b>						
$A_{OL}$	Open-loop voltage gain	$V_S = 2.7\text{ V}, 0.3\text{ V} < V_O < (V_+) - 0.3\text{ V}, R_L = 1\text{ k}\Omega$	88	100		dB
		$V_S = 5.5\text{ V}, 0.3\text{ V} < V_O < (V_+) - 0.3\text{ V}, R_L = 1\text{ k}\Omega$	90	110		dB
		$T_A = -40^\circ\text{C to }+85^\circ\text{C}$ $V_S = 5.5\text{ V}, 0.3\text{ V} < V_O < (V_+) - 0.3\text{ V}, R_L = 1\text{ k}\Omega$	84			dB
<b>FREQUENCY RESPONSE</b>						
	Gain bandwidth product	$V_S = 3.3\text{ V}, R_L = 1\text{ k}\Omega, C_L = 10\text{ pF}, G = 10$		90		MHz
		$V_S = 5.0\text{ V}, R_L = 1\text{ k}\Omega, C_L = 10\text{ pF}, G = 10$		100		MHz
	Small-signal bandwidth	$V_S = 5.0\text{ V}, G = 1, V_O = 0.1\text{ V}_{PP}, R_F = 25\text{ }\Omega$		250		MHz
		$V_S = 5.0\text{ V}, G = 2, V_O = 0.1\text{ V}_{PP}, R_F = 25\text{ }\Omega$		90		MHz
SR	Slew rate	$V_S = 3.3\text{ V}, G = 1, 2\text{-V step}$		110		V/ $\mu\text{s}$
		$V_S = 5\text{ V}, G = 1, 2\text{-V step}$		130		V/ $\mu\text{s}$
		$V_S = 5\text{ V}, G = 1, 4\text{-V step}$		150		V/ $\mu\text{s}$
$t_r$	Rise time	$V_S = 5\text{ V}, G = 1, V_O = 2\text{ V}_{PP}, 10\% \text{ to } 90\%$		11		ns
$t_f$	Fall time	$V_S = 5\text{ V}, G = 1, V_O = 2\text{ V}_{PP}, 90\% \text{ to } 10\%$		11		ns
$t_s$	Settling time	To 0.1%, $V_S = 3.3\text{ V}, G = 1, 2\text{-V step}$		30		ns
		To 0.01%, $V_S = 3.3\text{ V}, G = 1, 2\text{-V step}$		60		ns
	Overload recovery time	$V_S = 3.3\text{ V}, V_{IN} \times \text{Gain} = V_S$		5		ns
<b>OUTPUT</b>						
	Voltage output swing from supply rails	$V_S = 5.5\text{ V}, R_L = 1\text{ k}\Omega$		100		mV
	Short-circuit current	$V_S = 5.0\text{ V}$		100		mA
		$V_S = 3.3\text{ V}$		50		mA
	Closed-loop output impedance			0.05		$\Omega$
	Open-loop output impedance			35		$\Omega$

- (1) Parameters with MIN and MAX specification limits are 100% production tested at  $+25^\circ\text{C}$ , unless otherwise noted. Over temperature limits are based on characterization and statistical analysis.
- (2) Specified by design and/or characterization; not production tested.

**ELECTRICAL CHARACTERISTICS:  $V_{SS} = +2.7\text{ V to }+5.5\text{ V}^{(1) (2)}$  (continued)**

At  $T_A = +25^\circ\text{C}$ ,  $R_L = 1\text{ k}\Omega$  connected to  $V_S / 2$ , and  $V_O = V_{CM} = V_S / 2$ , unless otherwise noted.

PARAMETER	CONDITIONS	OPA1S238x			UNIT
		MIN	TYP	MAX	
<b>POWER SUPPLY</b>					
$V_S$ Operating supply range		2.7		5.5	V
$I_Q$ Quiescent current	$V_S = 5.5\text{ V}$ , $I_O = 0\text{ mA}$		9.8	12	mA
<b>TEMPERATURE</b>					
Specified range		-40		+85	$^\circ\text{C}$
Operating range		-40		+125	$^\circ\text{C}$
Storage range		-65		+150	$^\circ\text{C}$

**ELECTRICAL CHARACTERISTICS: Switch Section<sup>(1)</sup>**

At  $T_A = +25^\circ\text{C}$  and  $V_S = 3.3\text{ V}$ , unless otherwise noted.

PARAMETER	CONDITIONS	OPA1S238x			UNIT
		MIN	TYP	MAX	
<b>DC</b>					
Analog voltage range	$V_S = 2.7\text{ V to }5.5\text{ V}$	0		$V_{S+}$	V
$r_{on}$ On-state resistance	$V_{IN} = V+ / 2$ , $I_{COM} = 10\text{ mA}$		7	16	$\Omega$
$I_{lkg}$ Off-state leakage current	$V_{IN} = V+ / 2$ , $V_{+IN\ B} = 0\text{ V}$	-0.5	0.01	0.5	nA
<b>DYNAMIC</b>					
$t_{ON}$ Turn-on time	$V_{IN} = V+ / 2$ , $C_L = 35\text{ pF}$ , $R_L = 300\ \Omega$		20		ns
$t_{OFF}$ Turn-off time	$V_{IN} = V+ / 2$ , $C_L = 35\text{ pF}$ , $R_L = 300\ \Omega$		15		ns
$Q_C$ Charge injection	$C_L = 1\text{ nF}$		1		pC
BW Bandwidth	Signal = 0 dBm (0.632 mV <sub>pp</sub> , 50 $\Omega$ )		450		MHz
Off isolation	f = 1 MHz, signal = 1 V <sub>rms</sub> , 50 $\Omega$		-82		dB
Off capacitance (IN_S)	Switch open, f = 1 MHz, $V_{BIAS} = 0\text{ V}$		6.5		pF
Off capacitance (+IN_B)	Switch open, f = 1 MHz, $V_{BIAS} = 0\text{ V}$		8.5		pF
On capacitance (IN_S)	Switch closed, f = 1 MHz, $V_{BIAS} = 0\text{ V}$		13		pF
On capacitance (+IN_B)	Switch closed, f = 1 MHz, $V_{BIAS} = 0\text{ V}$		15		pF
<b>DIGITAL CONTROL INPUT (SC pin)</b>					
$V_{IH}$ High-level input voltage	$V_S = 5.5\text{ V}$ , $T_A = -40^\circ\text{C to }+85^\circ\text{C}$	2.4		$V_{S+}$	V
	$V_S = 3.3\text{ V}$ , $T_A = -40^\circ\text{C to }+85^\circ\text{C}$	2.0		$V_{S+}$	V
$V_{IL}$ Low-level input voltage		0		0.9	V
$I_{lkg(SC)}$ Input leakage current	$V_{IN\ S} = V+$ or $0\text{ V}$	-0.5	0.01	0.5	$\mu\text{A}$
	$T_A = -40^\circ\text{C to }+85^\circ\text{C}$	-5		5	$\mu\text{A}$
Input capacitance			3		pF

(1) Parameters with MIN and MAX specification limits are 100% production tested at  $+25^\circ\text{C}$ , unless otherwise noted. Over temperature limits are based on characterization and statistical analysis.

**THERMAL INFORMATION**

THERMAL METRIC <sup>(1)</sup>		OPA1S238x		UNITS
		DRC (SON)		
		10 PINS		
$\theta_{JA}$	Junction-to-ambient thermal resistance	46.2		$^\circ\text{C/W}$
$\theta_{JCTop}$	Junction-to-case (top) thermal resistance	53.8		
$\theta_{JB}$	Junction-to-board thermal resistance	21.7		
$\Psi_{JT}$	Junction-to-top characterization parameter	1.1		
$\Psi_{JB}$	Junction-to-board characterization parameter	21.9		
$\theta_{JCbott}$	Junction-to-case (bottom) thermal resistance	6.1		

(1) For more information about traditional and new thermal metrics, see the *IC Package Thermal Metrics* application report, [SPRA953](#).

## PIN CONFIGURATION

DRC PACKAGE  
DFN-10  
(TOP VIEW)

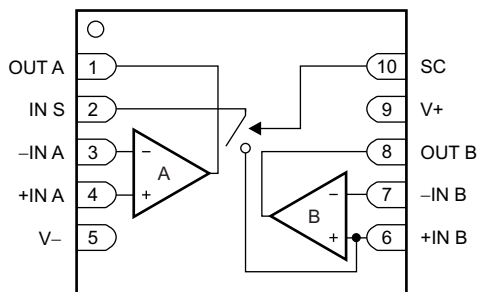

## PIN DESCRIPTIONS

PIN		DESCRIPTION
NAME	NO.	
+IN A	4	Noninverting input of amplifier channel A
-IN A	3	Inverting input of amplifier channel A
+IN B	6	Noninverting input of amplifier channel B
-IN B	7	Inverting input of amplifier channel B
IN S	2	Switch input
OUT A	1	Voltage output of amplifier channel A
OUT B	8	Voltage output of amplifier channel B
SC	10	Switch control pin. This logic input pin controls the SPST switch operation. For the OPA1S2384, a logic-low signal opens the switch and a logic-high signal closes the switch. For the OPA1S2385, a logic-low signal closes the switch and a logic high signal opens the switch.
V+	9	Positive supply voltage pin. Connect this pin to a voltage +2.7V to +5.5V.
V-	5	Negative supply voltage pin. Connect this pin to the ground (0 V) rail of the single-supply system power supply.

## FUNCTIONAL BLOCK DIAGRAM

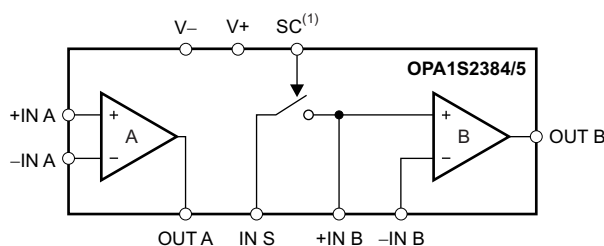

(1) Polarity of the SC pins depends on ordering option.

## TYPICAL CHARACTERISTICS

At  $T_A = +25^\circ\text{C}$ ,  $R_L = 1\text{ k}\Omega$  connected to  $V_S / 2$ , and  $V_O = V_{CM} = V_S / 2$ , unless otherwise noted.

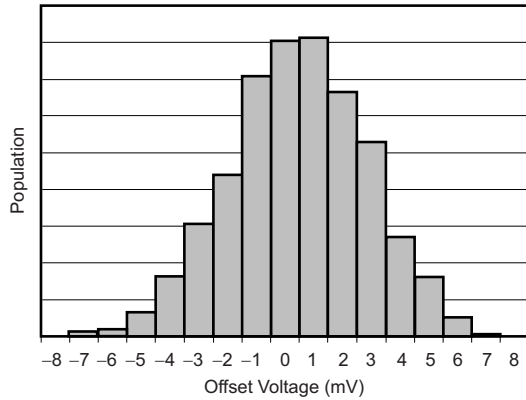

Figure 1. OFFSET VOLTAGE PRODUCTION DISTRIBUTION

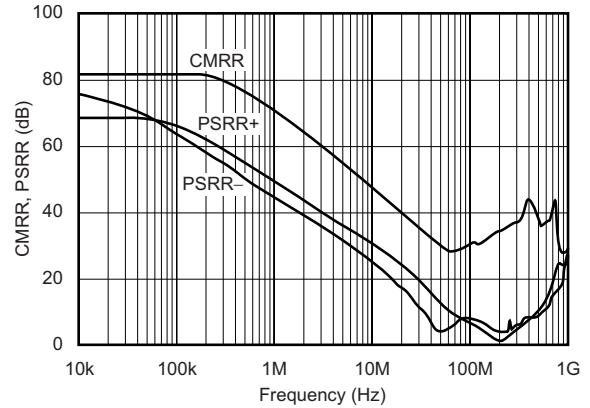

Figure 2. COMMON-MODE REJECTION RATIO AND POWER-SUPPLY REJECTION RATIO vs FREQUENCY

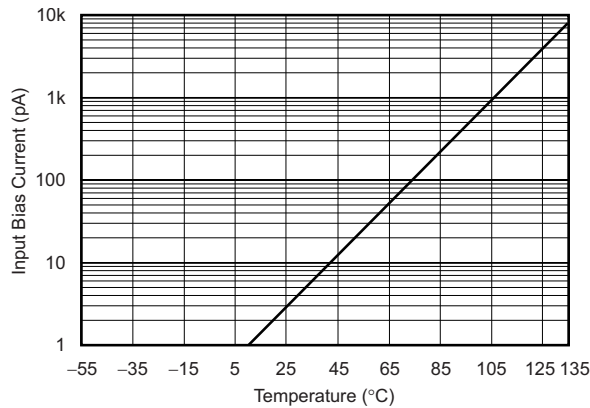

Figure 3. INPUT BIAS CURRENT vs TEMPERATURE

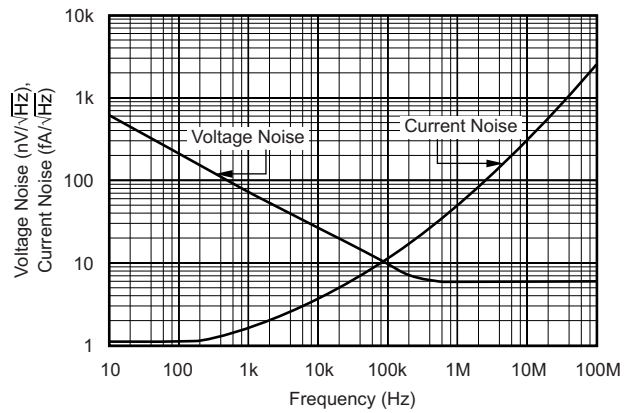

Figure 4. INPUT VOLTAGE AND CURRENT NOISE SPECTRAL DENSITY vs FREQUENCY

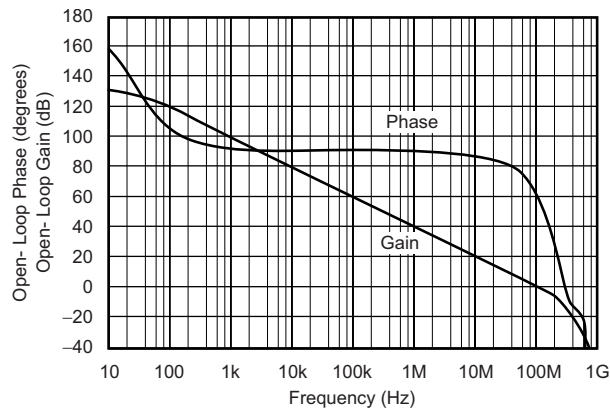

Figure 5. OPEN-LOOP GAIN AND PHASE

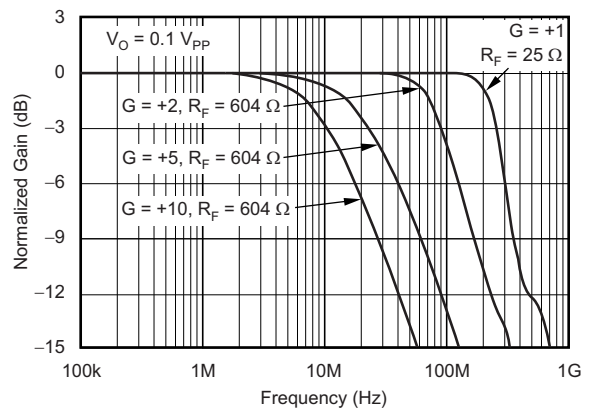
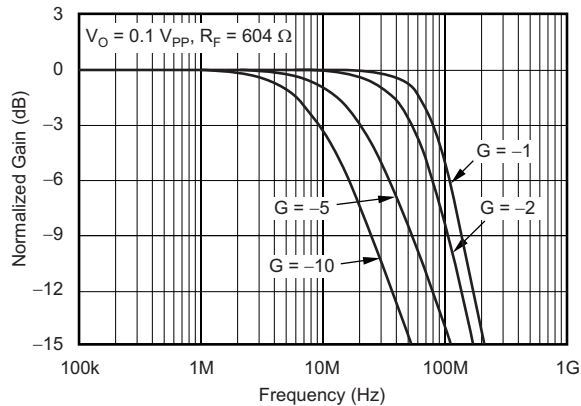

Figure 6. NONINVERTING SMALL-SIGNAL FREQUENCY RESPONSE

**TYPICAL CHARACTERISTICS (continued)**

At  $T_A = +25^\circ\text{C}$ ,  $R_L = 1\text{ k}\Omega$  connected to  $V_S / 2$ , and  $V_O = V_{CM} = V_S / 2$ , unless otherwise noted.



**Figure 7. INVERTING SMALL-SIGNAL FREQUENCY RESPONSE**

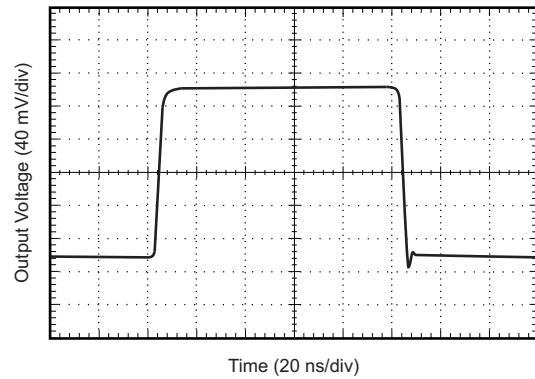

**Figure 8. NONINVERTING SMALL-SIGNAL STEP RESPONSE**

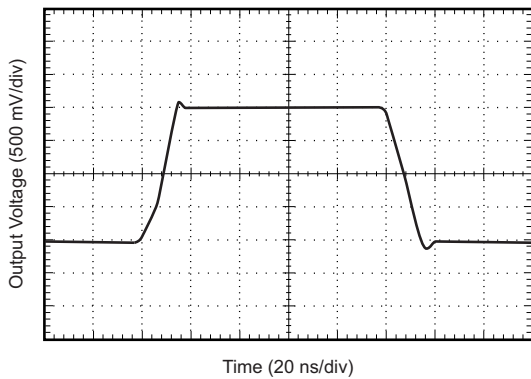

**Figure 9. NONINVERTING LARGE-SIGNAL STEP RESPONSE**

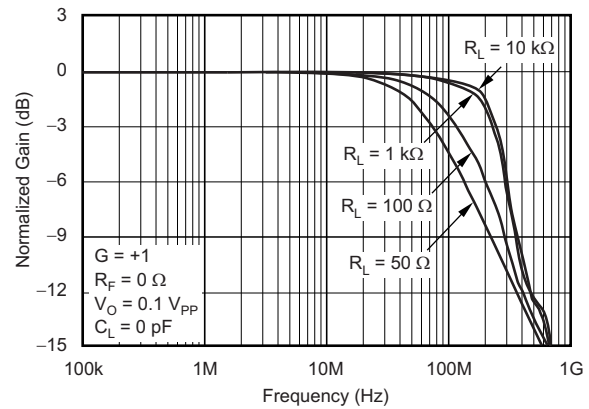

**Figure 10. FREQUENCY RESPONSE FOR VARIOUS  $R_L$**

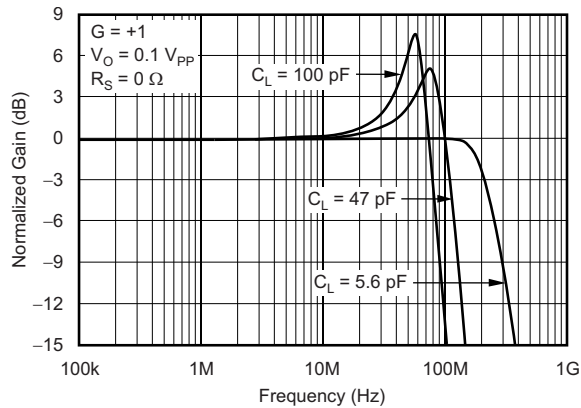

**Figure 11. FREQUENCY RESPONSE FOR VARIOUS  $C_L$**

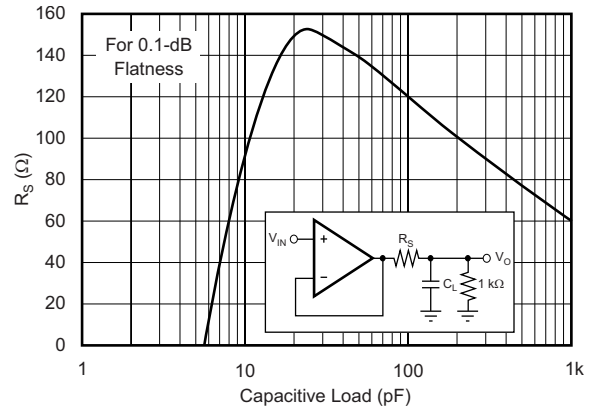

**Figure 12. RECOMMENDED  $R_S$  vs CAPACITIVE LOAD**

**TYPICAL CHARACTERISTICS (continued)**

At  $T_A = +25^\circ\text{C}$ ,  $R_L = 1\text{ k}\Omega$  connected to  $V_S / 2$ , and  $V_O = V_{CM} = V_S / 2$ , unless otherwise noted.

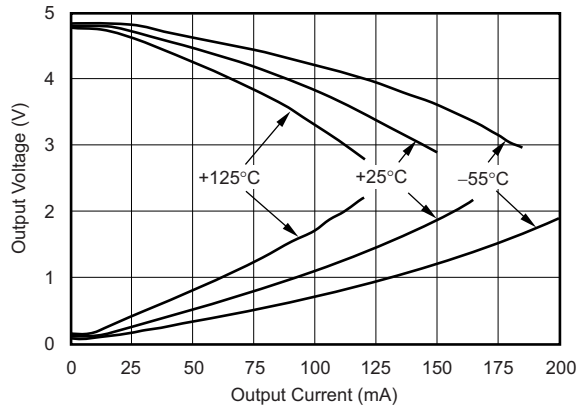

**Figure 13. OUTPUT VOLTAGE SWING vs OUTPUT CURRENT**

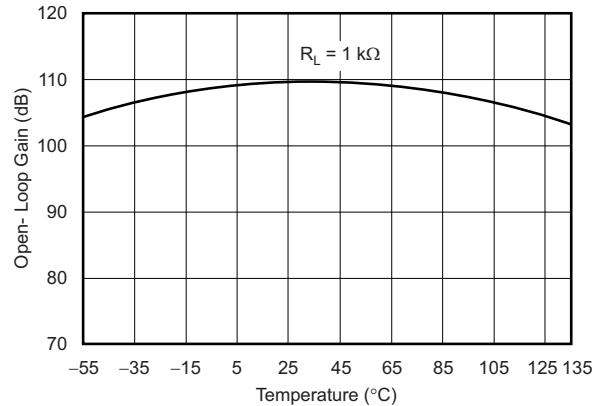

**Figure 14. OPEN-LOOP GAIN vs TEMPERATURE**

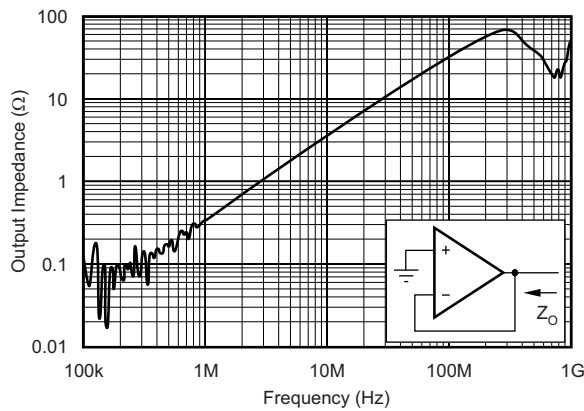

**Figure 15. CLOSED-LOOP OUTPUT IMPEDANCE vs FREQUENCY**

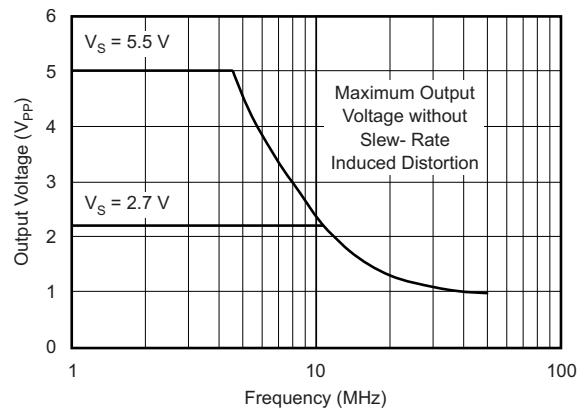

**Figure 16. MAXIMUM OUTPUT VOLTAGE vs FREQUENCY**

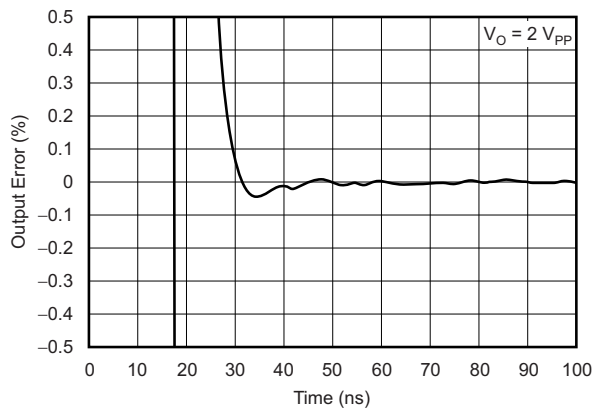

**Figure 17. OUTPUT SETTLING TIME TO 0.1%**

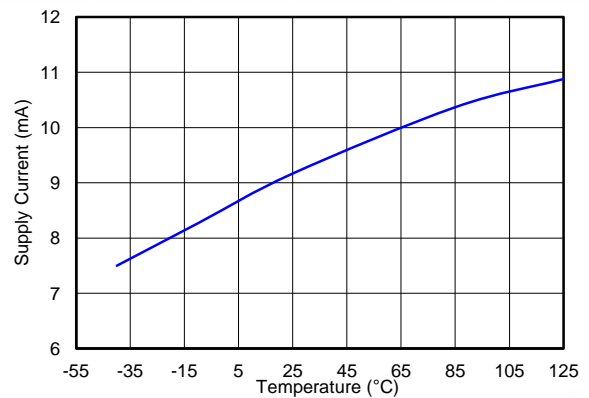

**Figure 18. SUPPLY CURRENT vs TEMPERATURE**



**TYPICAL CHARACTERISTICS (continued)**

At  $T_A = +25^\circ\text{C}$ ,  $R_L = 1\text{ k}\Omega$  connected to  $V_S / 2$ , and  $V_O = V_{CM} = V_S / 2$ , unless otherwise noted.

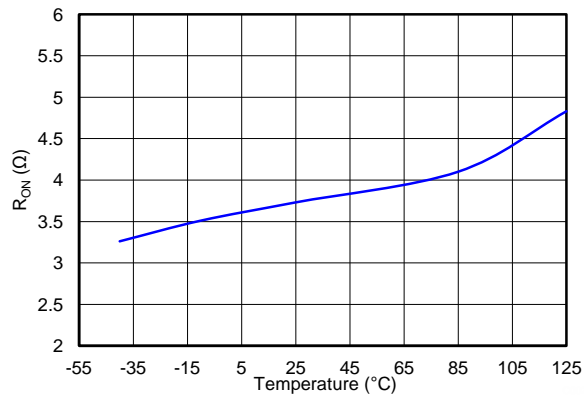

Figure 19.  $R_{ON}$  vs TEMPERATURE

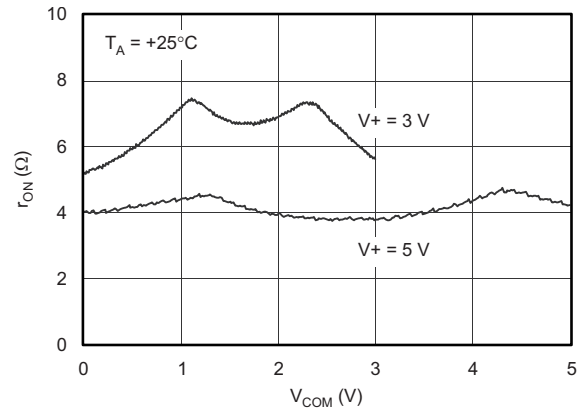

Figure 20.  $r_{ON}$  vs  $V_{COM}$

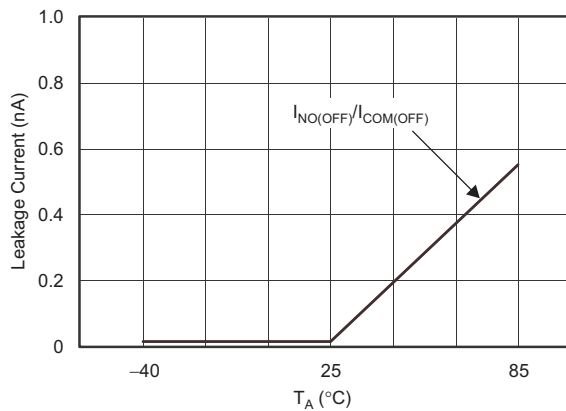

Figure 21. LEAKAGE CURRENT vs TEMPERATURE

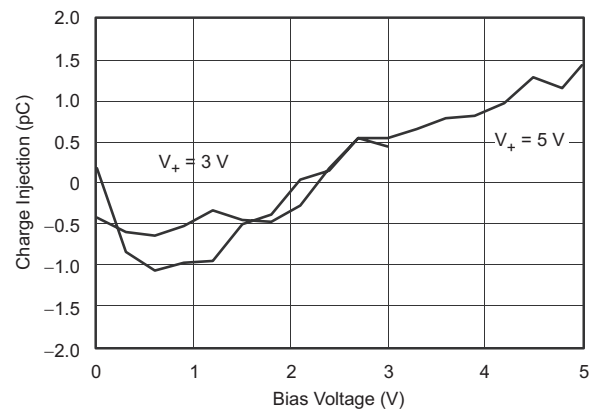

Figure 22. CHARGE-INJECTION ( $Q_C$ ) vs  $V_{COM}$

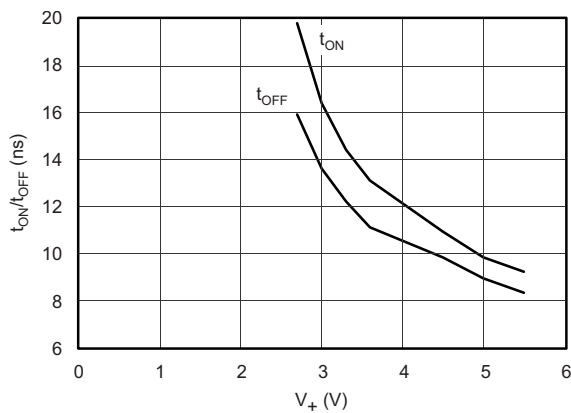

Figure 23.  $t_{ON}$  AND  $t_{OFF}$  vs SUPPLY VOLTAGE

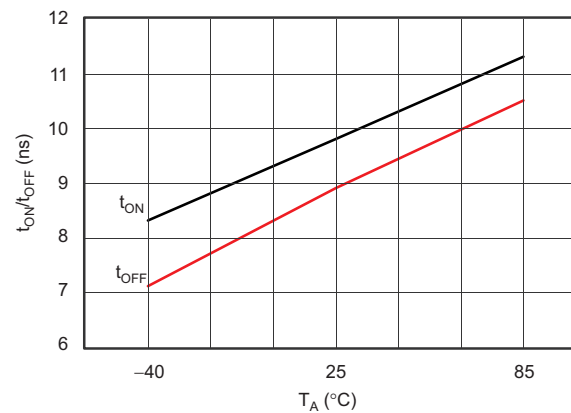
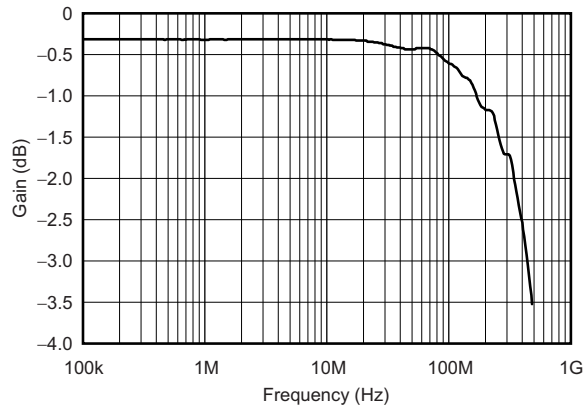

Figure 24.  $t_{ON}$  AND  $t_{OFF}$  vs TEMPERATURE ( $V_+ = 5\text{ V}$ )

**TYPICAL CHARACTERISTICS (continued)**

At  $T_A = +25^\circ\text{C}$ ,  $R_L = 1\text{ k}\Omega$  connected to  $V_S / 2$ , and  $V_O = V_{CM} = V_S / 2$ , unless otherwise noted.



**Figure 25. GAIN vs FREQUENCY**

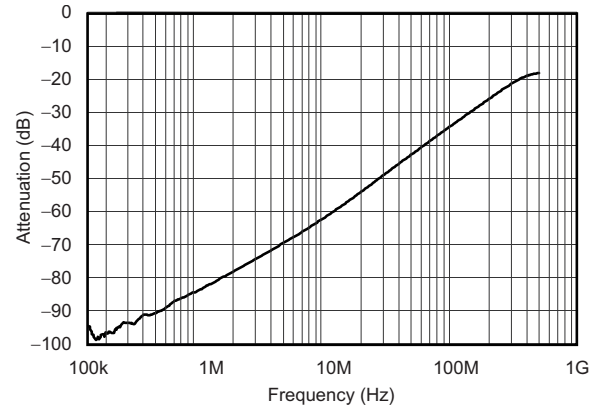

**Figure 26. OFF ISOLATION vs FREQUENCY**

## APPLICATION INFORMATION

### OPERATING VOLTAGE

The OPA1S238x operates over a power-supply range of +2.7 V to +5.5 V. Supply voltages higher than +6 V (absolute maximum) can permanently damage the device. Parameters that vary over supply voltage or over temperature are shown in the [Typical Characteristics](#) section of this data sheet.

### INPUT VOLTAGE

The OPA1S238x input common-mode voltage range extends 0.1 V beyond the supply rails. Under normal operating conditions, the input bias current is approximately 3 pA. Input voltages exceeding the supply voltage can cause excessive current to flow into or out of the input pins. If there is a possibility that this operating condition may occur, the inputs must be protected. Momentary voltages that exceed the supply voltage can be tolerated if the input current is limited to 10 mA. This limitation is easily accomplished with an input resistor between the signal and the input pin of the device.

### OUTPUT VOLTAGE

Rail-to-rail output is achieved by using a class AB output stage with common-source transistors. For high-impedance loads ( $> 200 \Omega$ ), the output voltage swing is typically 100 mV from the supply rails. With 10- $\Omega$  loads, a useful output swing can be achieved while maintaining high open-loop gain; see [Figure 13](#).

### OUTPUT DRIVE

The OPA1S238x output stage can supply a continuous output current of  $\pm 100$  mA and still provide approximately 2.7 V of output swing on a 5-V supply; see [Figure 13](#).

The OPA1S238x provides peak currents of up to 200 mA, which corresponds to the typical short-circuit current. Therefore, an on-chip thermal shutdown circuit is provided to protect the OPA1S238x from dangerously-high junction temperatures. At +160°C, the protection circuit shuts down the amplifier. Normal operation resumes when the junction temperature cools to below +140°C.

### CAPACITIVE LOAD AND STABILITY

The OPA1S238x can drive a wide range of capacitive loads. However, all op amps can become unstable under certain conditions. Op amp configuration, gain, and load value are just a few of the factors to consider when determining stability. An op amp in a unity-gain configuration is most susceptible to the effects of capacitive loading. The capacitive load reacts with the op amp output resistance, along with any additional load resistance, to create a pole in the small-signal response that degrades the phase margin; see [Figure 12](#) for details.

The OPA1S238x topology enhances its ability to drive capacitive loads. In unity gain, these op amps perform well with large capacitive loads. See [Figure 10](#) and [Figure 11](#) for details.

One method of improving capacitive load drive in the unity-gain configuration is to insert a 10- $\Omega$  to 20- $\Omega$  resistor in series with the output. This resistor significantly reduces ringing with large capacitive loads. For details about stability with certain output capacitors, see [Figure 11](#). However, if there is a resistive load in parallel with the capacitive load,  $R_S$  creates a voltage divider. This voltage divider, introduces a dc error at the output and slightly reduces output swing. This error may be insignificant. For instance, with  $R_L = 10$  k $\Omega$  and  $R_S = 20 \Omega$ , there is only about a 0.2% error at the output.

### WIDEBAND TRANSIMPEDANCE AMPLIFIER

Wide bandwidth, low input bias current and low current noise make the OPA1S238x an ideal wideband, photodiode, transimpedance amplifier for low-voltage, single-supply applications. Low-voltage noise is important because photodiode capacitance causes the effective noise gain of the circuit to increase at high frequencies.

### POWER DISSIPATION

Power dissipation depends on power-supply voltage, signal, and load conditions. With dc signals, power dissipation is equal to the product of output current times the voltage across the conducting output transistor. Power dissipation can be minimized by using the lowest possible power-supply voltage necessary to assure the required output voltage swing.

For resistive loads, the maximum power dissipation occurs at a dc output voltage of one-half the power-supply voltage. Dissipation with ac signals is lower. Application bulletin AB-039 (SBOA022), *Power Amplifier Stress and Power Handling Limitations*, explains how to calculate or measure power dissipation with unusual signals and loads, and is available for download at www.ti.com.

Repeated activation of the thermal protection circuit indicates excessive power dissipation or an inadequate heatsink. For reliable operation, junction temperature should be limited to +150°C, maximum. To estimate the margin of safety in a complete design, increase the ambient temperature until the thermal protection is triggered at +160°C. However, for reliable operation, design your system to operate at a maximum of 35°C below the thermal protection trigger temperature (that is, +125°C or less).

## TYPICAL APPLICATIONS

The following sections show typical applications of the OPA1S238x and explain their basic functionality.

### Signal Strength Detection

The OPA1S238x can be used to detect the signal strength of a fast changing optical signal. Figure 27 shows a simplified circuit for this application.

Optical sensors like photodiodes often generate a current that is proportional to the amount of light detected by these sensors. The current generated by this sensor is represented by the current source  $I_{IN}$ , as shown in Figure 27. One of the OPA1S238x op amps is configured in a transimpedance configuration. If it is assumed that this op amp behaves like an ideal op amp, then all the current generated by  $I_{IN}$  flows through R1 and generates a voltage drop of  $I_{IN} \times R1$ . The voltage at the output of this op amp can then be calculated by  $V_{TIA} = V_{BIAS} + I_{IN} \times R1$ . This calculation assumes ideal components.

In real-life applications, the current generated by  $I_{IN}$  can change very quickly. The current at a specific point in time can be measured by using the internal switch of the OPA1S238x. When the switch is closed, the C2 capacitor is charged to the output voltage level of the first amplifier ( $V_{TIA}$ ). By opening the switch, the output is disconnected from C2, and the voltage at the noninverting terminal of the second op amp remains at the same voltage level as when the switch was opened. The second op amp is configured in a buffer configuration and prevents the C2 capacitor from being discharged by a load at the  $V_{OUT}$  terminal.

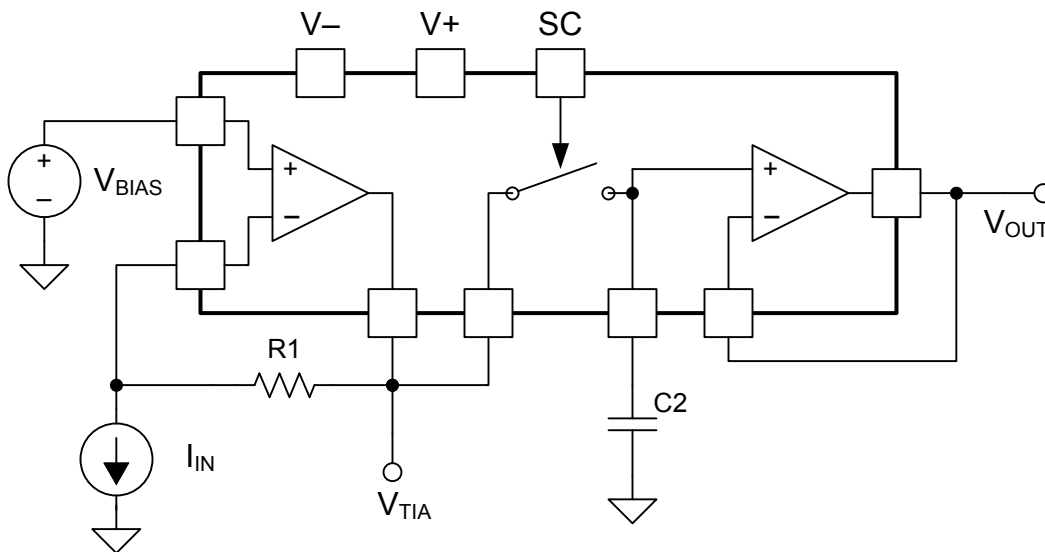

Figure 27. Signal Strength Detection

## Sample and Hold

The OPA1S238x can be used in a basic sample-and-hold configuration. Figure 28 shows the simplified circuit for this application.

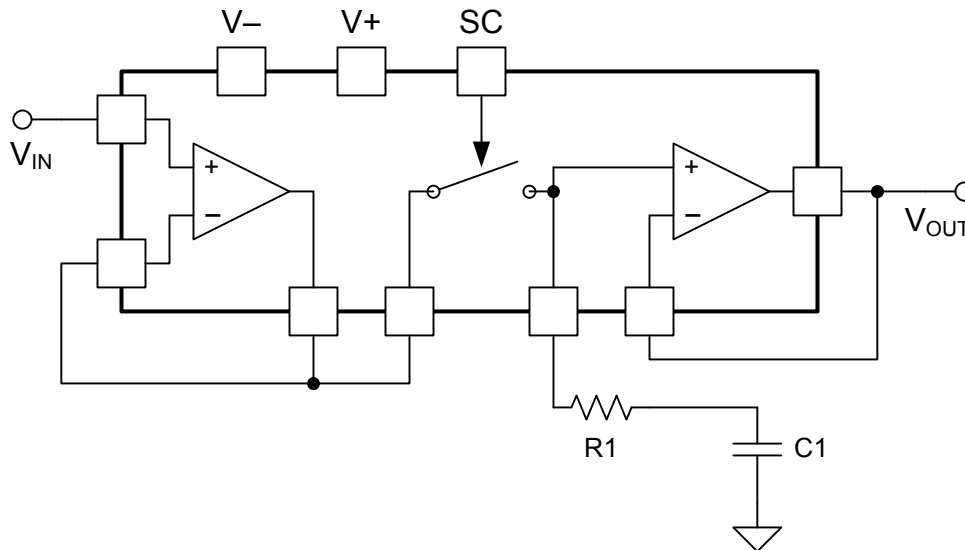

Figure 28. Sample-and-Hold Circuit

This sample-and-hold circuit can be used to sample the  $V_{IN}$  voltage at a specific point in time and hold it at  $V_{OUT}$ . This functionality is especially useful when fast-moving signals must be digitized.

When the switch connecting the two op amps is closed, the circuit operates in *track mode*. In track mode, if ideal components are assumed, the voltage at  $V_{OUT}$  follows the voltage at  $V_{IN}$ , only delayed by a filter consisting of  $R1$  and  $C1$ .

As soon as the internal switch is opened, the output voltage no longer follows the input voltage. If ideal components are assumed again, the change in  $C1$  remains constant and voltage at  $V_{OUT}$  reflects the voltage at  $V_{IN}$  at the moment that the switch was opened.

The values of  $R1$  and  $C1$  must be chosen depending on the bandwidth of the input signal, the sample time, and the hold time. Long hold times require larger capacitors in order to reduce the error from any leakage currents coming out of  $C1$ . Short sample times require smaller capacitors to allow for fast settling. Choose the  $R1$  value according to Figure 12 to prevent ringing or excessive damping.

There are several error sources that should be considered when designing a sample-and-hold circuit. The most important ones are:

- **Aperture Time** is the time required for a switch to open and remove the charging signal from the capacitor after the mode control signal has changed from sample to hold.
- **Effective Aperture Time** is the difference in propagation delay times of the analog signal and the mode control signal from their respective input pins to the switch.
- **Charge Offset** is the output voltage change that results from a charge transfer into the hold capacitor through stray capacitance when Hold mode is enabled.
- **Droop Rate** is the change in output voltage over time during Hold mode as a result of hold capacitor leakage, switch leakage, and bias current of the output amplifier.
- **Drift Current** is the net leakage current affecting the hold capacitor during Hold mode.
- **Hold Mode Feedthrough** is the fraction of the input signal that appears at the output while in Hold mode. It is primarily a function of switch capacitance, but may also be increased by poor layout practices.
- **Hold Mode Settling Time** is the time required for the sample-to-hold transient to settle within a specified error band.

**PACKAGING INFORMATION**

Orderable Device	Status (1)	Package Type	Package Drawing	Pins	Package Qty	Eco Plan (2)	Lead/Ball Finish	MSL Peak Temp (3)	Samples (Requires Login)
OPA1S2385IDRCR	PREVIEW	SON	DRC	10	3000	Green (RoHS & no Sb/Br)	CU NIPDAU	Level-2-260C-1 YEAR	
OPA1S2385IDRCT	PREVIEW	SON	DRC	10	250	Green (RoHS & no Sb/Br)	CU NIPDAU	Level-2-260C-1 YEAR	

(1) The marketing status values are defined as follows:

**ACTIVE:** Product device recommended for new designs.

**LIFEBUY:** TI has announced that the device will be discontinued, and a lifetime-buy period is in effect.

**NRND:** Not recommended for new designs. Device is in production to support existing customers, but TI does not recommend using this part in a new design.

**PREVIEW:** Device has been announced but is not in production. Samples may or may not be available.

**OBSELETE:** TI has discontinued the production of the device.

(2) Eco Plan - The planned eco-friendly classification: Pb-Free (RoHS), Pb-Free (RoHS Exempt), or Green (RoHS & no Sb/Br) - please check <http://www.ti.com/productcontent> for the latest availability information and additional product content details.

**TBD:** The Pb-Free/Green conversion plan has not been defined.

**Pb-Free (RoHS):** TI's terms "Lead-Free" or "Pb-Free" mean semiconductor products that are compatible with the current RoHS requirements for all 6 substances, including the requirement that lead not exceed 0.1% by weight in homogeneous materials. Where designed to be soldered at high temperatures, TI Pb-Free products are suitable for use in specified lead-free processes.

**Pb-Free (RoHS Exempt):** This component has a RoHS exemption for either 1) lead-based flip-chip solder bumps used between the die and package, or 2) lead-based die adhesive used between the die and leadframe. The component is otherwise considered Pb-Free (RoHS compatible) as defined above.

**Green (RoHS & no Sb/Br):** TI defines "Green" to mean Pb-Free (RoHS compatible), and free of Bromine (Br) and Antimony (Sb) based flame retardants (Br or Sb do not exceed 0.1% by weight in homogeneous material)

(3) MSL, Peak Temp. -- The Moisture Sensitivity Level rating according to the JEDEC industry standard classifications, and peak solder temperature.

**Important Information and Disclaimer:** The information provided on this page represents TI's knowledge and belief as of the date that it is provided. TI bases its knowledge and belief on information provided by third parties, and makes no representation or warranty as to the accuracy of such information. Efforts are underway to better integrate information from third parties. TI has taken and continues to take reasonable steps to provide representative and accurate information but may not have conducted destructive testing or chemical analysis on incoming materials and chemicals. TI and TI suppliers consider certain information to be proprietary, and thus CAS numbers and other limited information may not be available for release.

In no event shall TI's liability arising out of such information exceed the total purchase price of the TI part(s) at issue in this document sold by TI to Customer on an annual basis.

DRC (S-PVSON-N10)

PLASTIC SMALL OUTLINE NO-LEAD

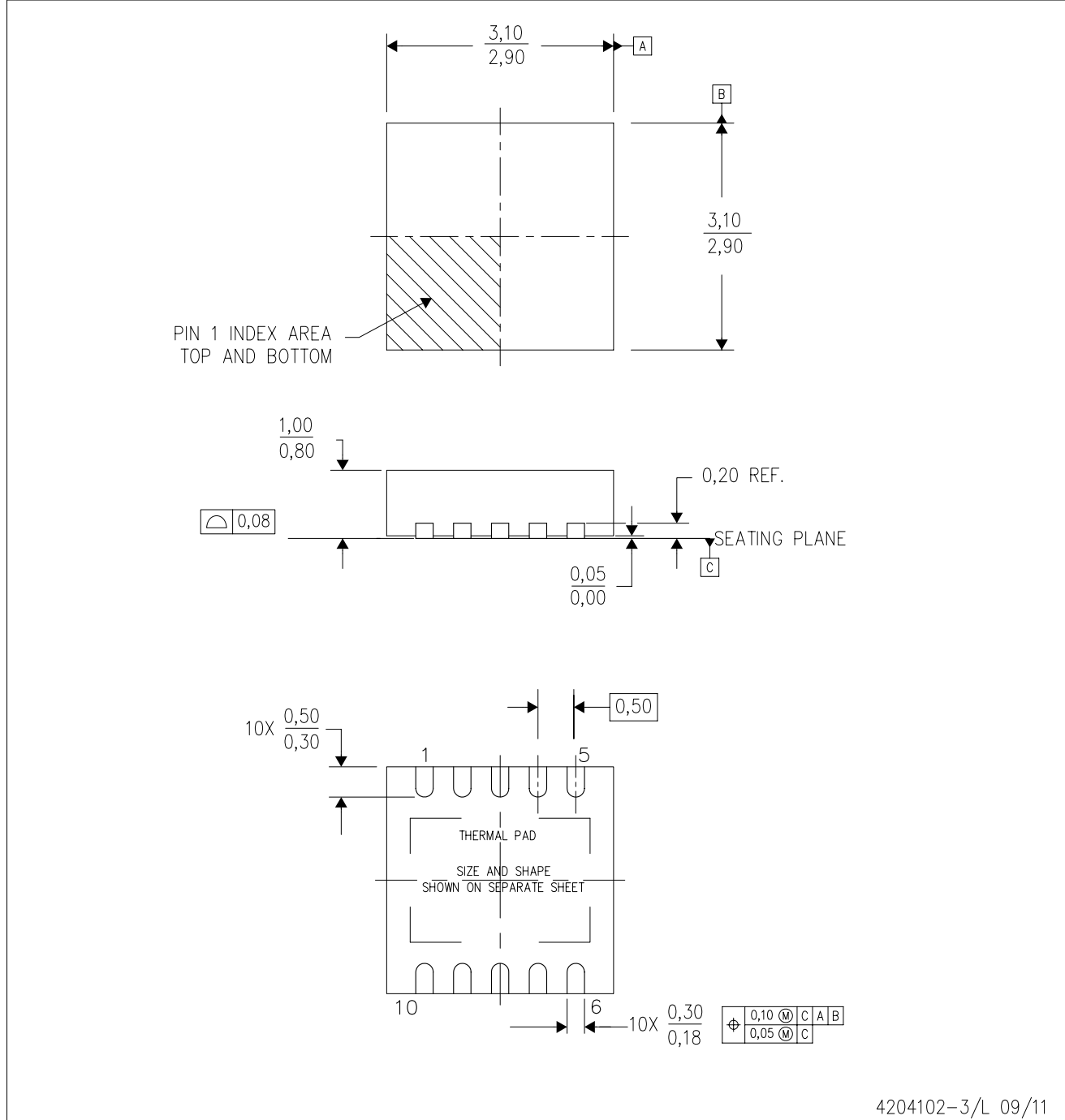

- NOTES:
- All linear dimensions are in millimeters. Dimensioning and tolerancing per ASME Y14.5M-1994.
  - This drawing is subject to change without notice.
  - Small Outline No-Lead (SON) package configuration.
  - The package thermal pad must be soldered to the board for thermal and mechanical performance, if present.
  - See the additional figure in the Product Data Sheet for details regarding the exposed thermal pad features and dimensions, if present

## IMPORTANT NOTICE

Texas Instruments Incorporated and its subsidiaries (TI) reserve the right to make corrections, enhancements, improvements and other changes to its semiconductor products and services per JESD46, latest issue, and to discontinue any product or service per JESD48, latest issue. Buyers should obtain the latest relevant information before placing orders and should verify that such information is current and complete. All semiconductor products (also referred to herein as "components") are sold subject to TI's terms and conditions of sale supplied at the time of order acknowledgment.

TI warrants performance of its components to the specifications applicable at the time of sale, in accordance with the warranty in TI's terms and conditions of sale of semiconductor products. Testing and other quality control techniques are used to the extent TI deems necessary to support this warranty. Except where mandated by applicable law, testing of all parameters of each component is not necessarily performed.

TI assumes no liability for applications assistance or the design of Buyers' products. Buyers are responsible for their products and applications using TI components. To minimize the risks associated with Buyers' products and applications, Buyers should provide adequate design and operating safeguards.

TI does not warrant or represent that any license, either express or implied, is granted under any patent right, copyright, mask work right, or other intellectual property right relating to any combination, machine, or process in which TI components or services are used. Information published by TI regarding third-party products or services does not constitute a license to use such products or services or a warranty or endorsement thereof. Use of such information may require a license from a third party under the patents or other intellectual property of the third party, or a license from TI under the patents or other intellectual property of TI.

Reproduction of significant portions of TI information in TI data books or data sheets is permissible only if reproduction is without alteration and is accompanied by all associated warranties, conditions, limitations, and notices. TI is not responsible or liable for such altered documentation. Information of third parties may be subject to additional restrictions.

Resale of TI components or services with statements different from or beyond the parameters stated by TI for that component or service voids all express and any implied warranties for the associated TI component or service and is an unfair and deceptive business practice. TI is not responsible or liable for any such statements.

Buyer acknowledges and agrees that it is solely responsible for compliance with all legal, regulatory and safety-related requirements concerning its products, and any use of TI components in its applications, notwithstanding any applications-related information or support that may be provided by TI. Buyer represents and agrees that it has all the necessary expertise to create and implement safeguards which anticipate dangerous consequences of failures, monitor failures and their consequences, lessen the likelihood of failures that might cause harm and take appropriate remedial actions. Buyer will fully indemnify TI and its representatives against any damages arising out of the use of any TI components in safety-critical applications.

In some cases, TI components may be promoted specifically to facilitate safety-related applications. With such components, TI's goal is to help enable customers to design and create their own end-product solutions that meet applicable functional safety standards and requirements. Nonetheless, such components are subject to these terms.

No TI components are authorized for use in FDA Class III (or similar life-critical medical equipment) unless authorized officers of the parties have executed a special agreement specifically governing such use.

Only those TI components which TI has specifically designated as military grade or "enhanced plastic" are designed and intended for use in military/aerospace applications or environments. Buyer acknowledges and agrees that any military or aerospace use of TI components which have **not** been so designated is solely at the Buyer's risk, and that Buyer is solely responsible for compliance with all legal and regulatory requirements in connection with such use.

TI has specifically designated certain components as meeting ISO/TS16949 requirements, mainly for automotive use. In any case of use of non-designated products, TI will not be responsible for any failure to meet ISO/TS16949.

### Products

Audio	<a href="http://www.ti.com/audio">www.ti.com/audio</a>
Amplifiers	<a href="http://amplifier.ti.com">amplifier.ti.com</a>
Data Converters	<a href="http://dataconverter.ti.com">dataconverter.ti.com</a>
DLP® Products	<a href="http://www.dlp.com">www.dlp.com</a>
DSP	<a href="http://dsp.ti.com">dsp.ti.com</a>
Clocks and Timers	<a href="http://www.ti.com/clocks">www.ti.com/clocks</a>
Interface	<a href="http://interface.ti.com">interface.ti.com</a>
Logic	<a href="http://logic.ti.com">logic.ti.com</a>
Power Mgmt	<a href="http://power.ti.com">power.ti.com</a>
Microcontrollers	<a href="http://microcontroller.ti.com">microcontroller.ti.com</a>
RFID	<a href="http://www.ti-rfid.com">www.ti-rfid.com</a>
OMAP Applications Processors	<a href="http://www.ti.com/omap">www.ti.com/omap</a>
Wireless Connectivity	<a href="http://www.ti.com/wirelessconnectivity">www.ti.com/wirelessconnectivity</a>

### Applications

Automotive and Transportation	<a href="http://www.ti.com/automotive">www.ti.com/automotive</a>
Communications and Telecom	<a href="http://www.ti.com/communications">www.ti.com/communications</a>
Computers and Peripherals	<a href="http://www.ti.com/computers">www.ti.com/computers</a>
Consumer Electronics	<a href="http://www.ti.com/consumer-apps">www.ti.com/consumer-apps</a>
Energy and Lighting	<a href="http://www.ti.com/energy">www.ti.com/energy</a>
Industrial	<a href="http://www.ti.com/industrial">www.ti.com/industrial</a>
Medical	<a href="http://www.ti.com/medical">www.ti.com/medical</a>
Security	<a href="http://www.ti.com/security">www.ti.com/security</a>
Space, Avionics and Defense	<a href="http://www.ti.com/space-avionics-defense">www.ti.com/space-avionics-defense</a>
Video and Imaging	<a href="http://www.ti.com/video">www.ti.com/video</a>

### TI E2E Community

[e2e.ti.com](http://e2e.ti.com)