

OPA1013

## Precision, Single-Supply DUAL OPERATIONAL AMPLIFIER

### FEATURES

- SINGLE POWER SUPPLY OPERATION
- INPUT VOLTAGE RANGE TO GROUND
- OUTPUT SWINGS NEAR GROUND
- LOW QUIESCENT CURRENT: 550 $\mu$ A max
- LOW  $V_{os}$ : 300 $\mu$ V max
- LOW DRIFT: 2.5 $\mu$ V/ $^{\circ}$ C max
- LOW  $I_{os}$ : 1.5nA max
- LOW NOISE: 0.55 $\mu$ Vp-p, 0.1Hz to 10Hz

### APPLICATIONS

- PRECISION INSTRUMENTATION
- BATTERY-POWERED EQUIPMENT
- BRIDGE AMPLIFIERS
- 4-20mA CURRENT TRANSMITTERS
- VOLTAGE COMPARATOR

### DESCRIPTION

The OPA1013 dual operational amplifier provides precision performance in single power supply and low power applications. It is laser trimmed for low offset voltage and drift, greatly reducing the large errors common with LM324-type op amps. Input offset current is also trimmed to reduce errors in high impedance applications.

The OPA1013 is characterized for operation at both +5V (single supply) and  $\pm 15$ V power supplies. When operated from a single supply, the input common-mode range includes ground and the output can swing to within 15mV of ground. Completely independent biasing networks eliminate interaction between the two amplifiers—even when one is used as a comparator.

The OPA1013 is available in an 8-pin plastic DIP specified for the 0 $^{\circ}$ C to +70 $^{\circ}$ C temperature range.

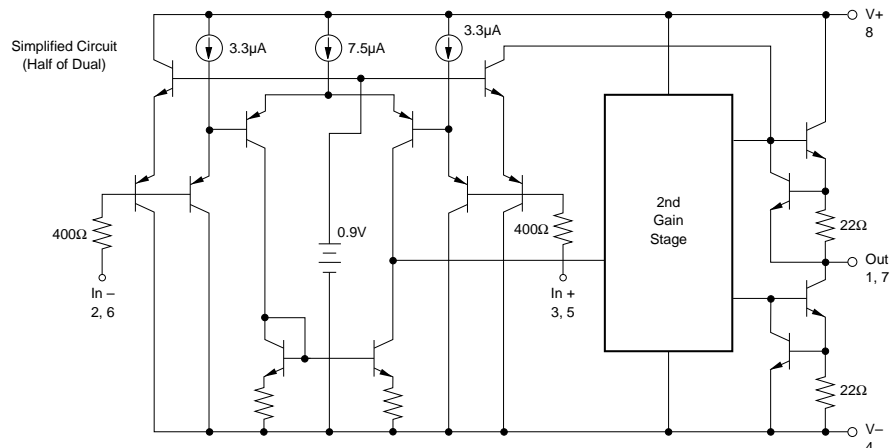

International Airport Industrial Park • Mailing Address: PO Box 11400 • Tucson, AZ 85734 • Street Address: 6730 S. Tucson Blvd. • Tucson, AZ 85706  
Tel: (520) 746-1111 • Twx: 910-952-1111 • Cable: BBRCORP • Telex: 066-6491 • FAX: (520) 889-1510 • Immediate Product Info: (800) 548-6132

# SPECIFICATIONS

## ELECTRICAL

$V_S = \pm 15V$ ,  $V_{CM} = 0V$ ,  $T_A = +25^\circ C$  unless otherwise noted.

PARAMETER	CONDITION	OPA1013CN8			OPA1013DN8			UNITS
		MIN	TYP	MAX	MIN	TYP	MAX	
Input Offset Voltage			±50	±300		±200	±800	μV
Time Stability			0.5			*		μV/Mo
Input Offset Current			±0.08	±1.5		*	*	nA
Input Bias Current			7	30		*	*	nA
Voltage Noise, BW = 0.1 to 10Hz			0.55			*		μVp-p
Noise Density, f = 10Hz			28			*		nV/√Hz
Noise Density, f = 1kHz			25			*		nV/√Hz
Current Noise Density, f = 10Hz			0.12			*		pA/√Hz
Input Resistance: Differential		70	300		*	*		MΩ
Input Resistance: Common-Mode			4			*		GΩ
Open-Loop Voltage Gain	$V_O = \pm 10V$ , $R_L = 2k\Omega$	1.2	2.9		*	*		V/μV
	$V_O = \pm 10V$ , $R_L = 600\Omega$	0.5	1.9		*	*		V/μV
Common-Mode Input Range		+13.5	+13.8		*	*		V
		-15	-15.3		*	*		V
Common-Mode Rejection	$V_{CM} = +13.5$ to $-15V$	97	114		*	*		dB
Power Supply Rejection	$V_S = \pm 2$ to $\pm 18V$	100	117		*	*		dB
Channel Separation	$V_O = \pm 10V$ , $R_L = 2k\Omega$	120	137		*	*		dB
Voltage Output	$R_L = 2k\Omega$	±12.5	±14		*	*		V
Slew Rate		0.2	0.35		*	*		V/μs
Quiescent Current (per amplifier)			±0.35	±0.55		*	*	mA

\*Specification same as OPA1013CN8.

$V_S = +5V/0V$ ,  $V_{CM} = 0V$ ,  $V_O = +1.4V$ ,  $T_A = +25^\circ C$  unless otherwise noted.

PARAMETER	CONDITION	OPA1013CN8			OPA1013DN8			UNITS
		MIN	TYP	MAX	MIN	TYP	MAX	
Input Offset Voltage			±90	±450		±250	±950	μV
Input Offset Current			±3.0	±2.0		*	*	nA
Input Bias Current			10	50		*	*	nA
Open-Loop Voltage Gain	$V_O = 5mV$ to $4V$ $R_L = 500\Omega$		0.1			*		V/μV
Common-Mode Input Range		+3.5	+3.8		*	*		V
		0	-0.3		*	*		V
Voltage Output Low	No Load		15	25		*	*	mV
Low	$R_L = 600\Omega$ to Ground		5	10		*	*	mV
Low	$I_{SINK} = 1mA$		200	350		*	*	mV
High	No Load	4	4.4		*	*		V
High	$R_L = 600\Omega$ to Ground	3.4	4		*	*		V
Quiescent Current (per amplifier)			0.33	0.5		*	*	mA

\*Specification same as OPA1013CN8.

$T_A = 0^\circ C$  to  $+70^\circ C$ ,  $V_S = \pm 15V$ ,  $V_{CM} = 0V$  unless otherwise noted.

PARAMETER	CONDITION	OPA1013CN8			OPA1013DN8			UNITS
		MIN	TYP	MAX	MIN	TYP	MAX	
Input Offset Voltage	$V_S = +5/0V$ , $V_O = +1.4V$		±80	±400		±230	±1000	μV
Input Offset Voltage Drift <sup>(1)</sup>			±110	±570		±280	±1200	μV/°C
Input Offset Current			0.4	2.5		0.7	5	μV/°C
Input Bias Current	$V_S = +5/0V$ , $V_O = +1.4V$		±0.3	±2.8		*	*	nA
			±0.5	±6		*	*	nA
Input Bias Current	$V_S = +5/0V$ , $V_O = +1.4V$		9	38		*	*	nA
			13	90		*	*	nA
Open-Loop Voltage Gain	$V_O = \pm 10V$ , $R_L = 2k\Omega$	0.7	2.2		*	*		V/μV
Common-Mode Rejection	$V_{CM} = +13$ to $-15V$	94	113		*	*		dB
Power Supply Rejection	$V_S = \pm 2$ to $\pm 18V$	97	116		*	*		dB
Voltage Output	$R_L = 2k\Omega$	±12.0	±13.9		*	*		V
$V_O$ Low	$V_S = +5/0V$ , $R_L = 600\Omega$		6	13		*	*	mV
$V_O$ High	$V_S = +5/0V$ , $R_L = 600\Omega$	3.2	3.9		*	*		V
Quiescent Current (per amplifier)			±0.37	±0.6		*	*	mA
	$V_S = +5/0V$ , $V_O = +1.4V$		0.34	0.55		*	*	mA

\*Specification same as OPA1013CN8.

NOTE: (1) Guaranteed by design. This specification is established to a 98% confidence level.

## DICE INFORMATION

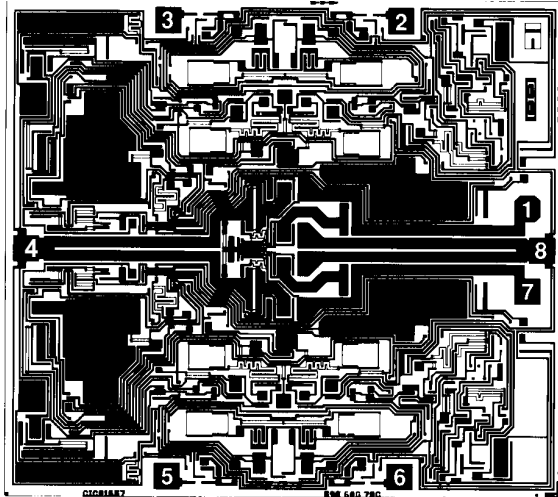

OPA1013 DIE TOPOGRAPHY

PAD	FUNCTION
1	Output A
2	-In A
3	+In A
4	V-
5	+In B
6	-In B
7	Output B
8	V+

Substrate Bias:  $-V_S$

## MECHANICAL INFORMATION

	MILS (0.001")	MILLIMETERS
Die Size	112 x 100 $\pm$ 5	2.84 x 2.54 $\pm$ 0.13
Die Thickness	20 $\pm$ 3	0.51 $\pm$ 0.08
Min. Pad Size	4 x 4	0.10 x 0.10
Transistor Count	92	
Backing	Gold	

## CONNECTION DIAGRAM

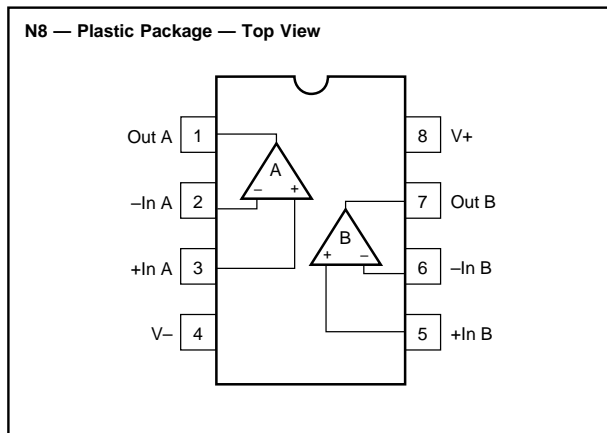

## ABSOLUTE MAXIMUM RATINGS

Power Supply Voltage	$\pm$ 22V
Differential Input Voltage	$\pm$ 30V
Input Voltage	V+ to (V-) -5V
Output Short Circuit ( $T_A = 25^\circ\text{C}$ )	Continuous
Operating Temperature	$0^\circ\text{C}$ to $+70^\circ\text{C}$
Storage Temperature	$-65$ to $+150^\circ\text{C}$
Lead Temperature (soldering, 10s)	$+300^\circ\text{C}$

## ORDERING INFORMATION

MODEL	PACKAGE	TEMPERATURE RANGE
OPA1013CN8	Plastic DIP	$0^\circ\text{C}$ to $+70^\circ\text{C}$
OPA1013DN8	Plastic DIP	$0^\circ\text{C}$ to $+70^\circ\text{C}$

## PACKAGE INFORMATION

MODEL	PACKAGE	PACKAGE DRAWING NUMBER <sup>(1)</sup>
OPA1013CN8	Plastic DIP	006
OPA1013DN8	Plastic DIP	006

NOTE: (1) For detailed drawing and dimension table, please see end of data sheet, or Appendix D of Burr-Brown IC Data Book.

The information provided herein is believed to be reliable; however, BURR-BROWN assumes no responsibility for inaccuracies or omissions. BURR-BROWN assumes no responsibility for the use of this information, and all use of such information shall be entirely at the user's own risk. Prices and specifications are subject to change without notice. No patent rights or licenses to any of the circuits described herein are implied or granted to any third party. BURR-BROWN does not authorize or warrant any BURR-BROWN product for use in life support devices and/or systems.

# TYPICAL PERFORMANCE CURVES

$T_A = +25^\circ\text{C}$  unless otherwise noted.

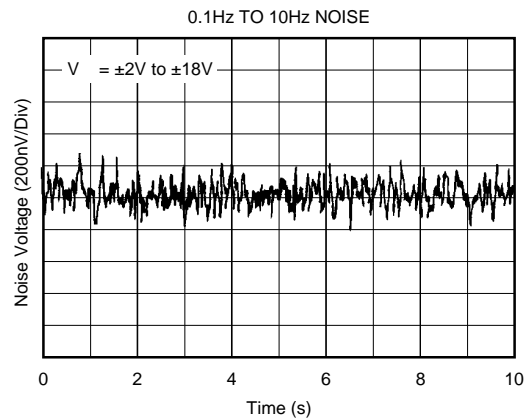
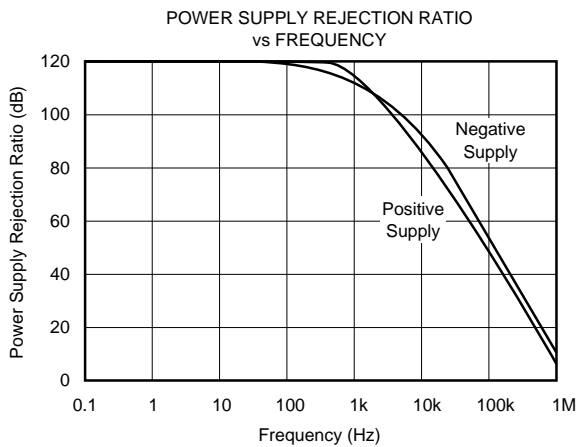
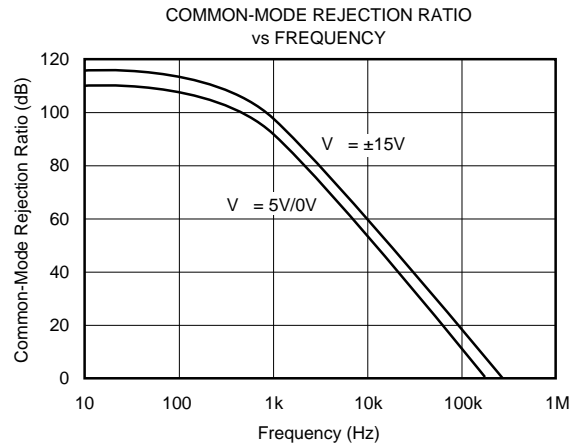
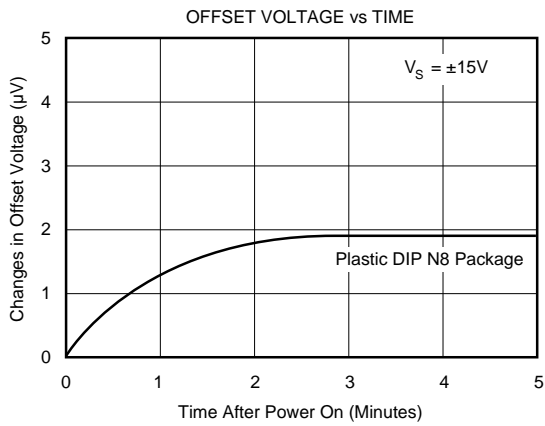
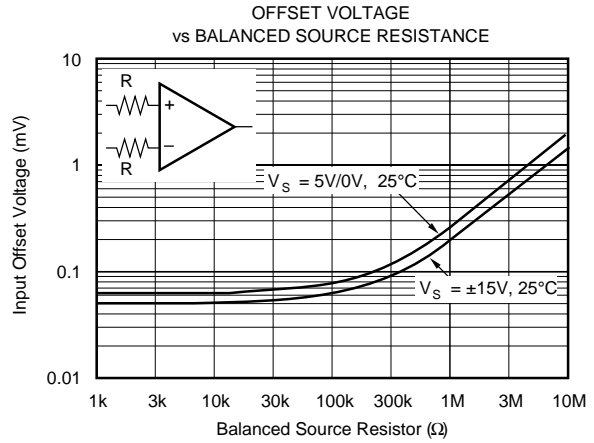
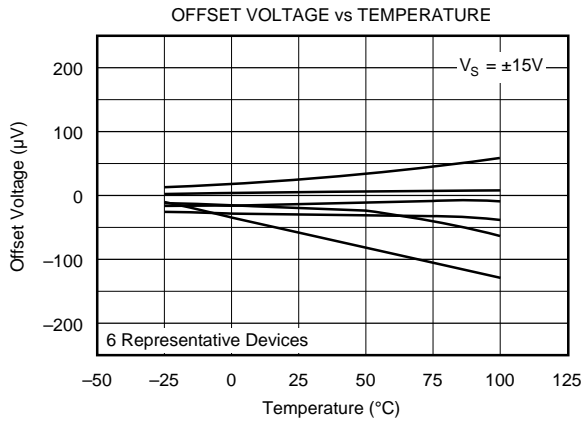

# TYPICAL PERFORMANCE CURVES (CONT)

$T_A = +25^\circ\text{C}$  unless otherwise noted.

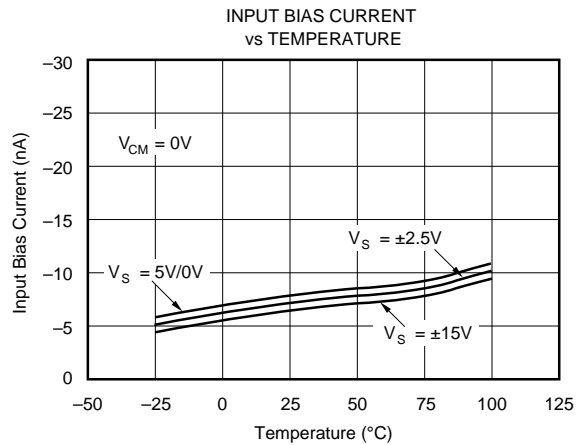
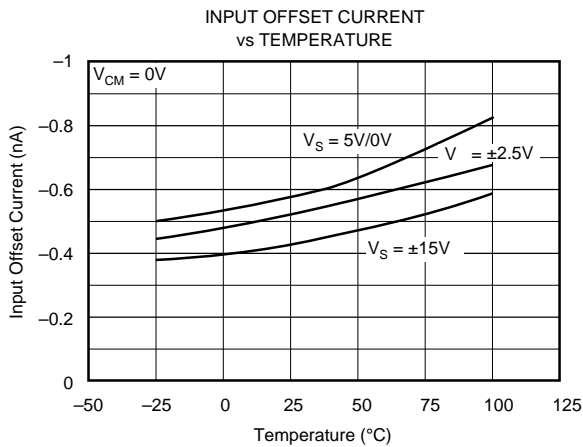
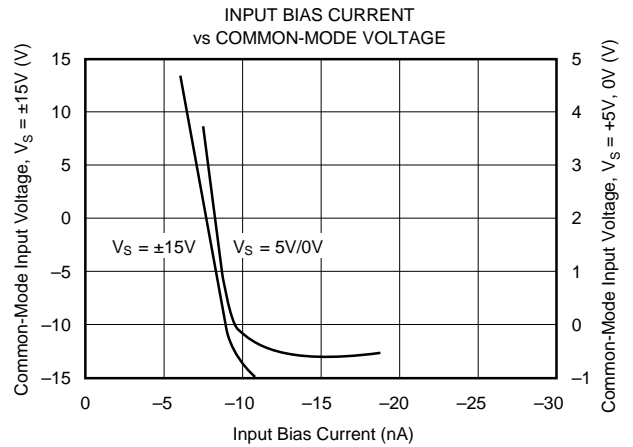
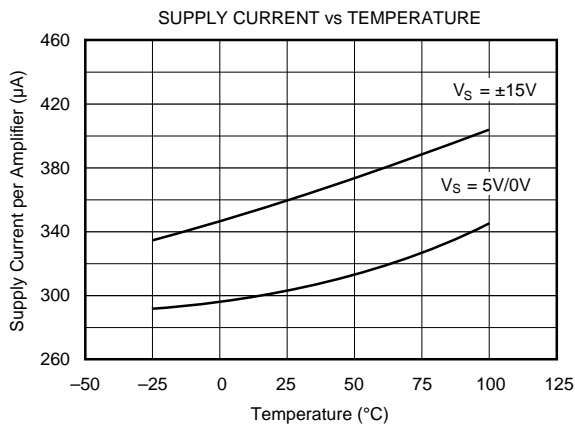
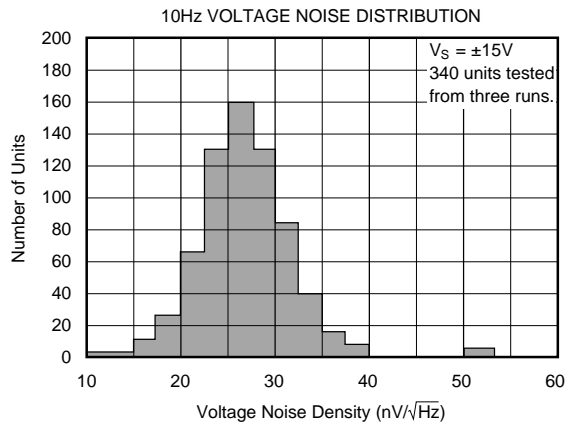
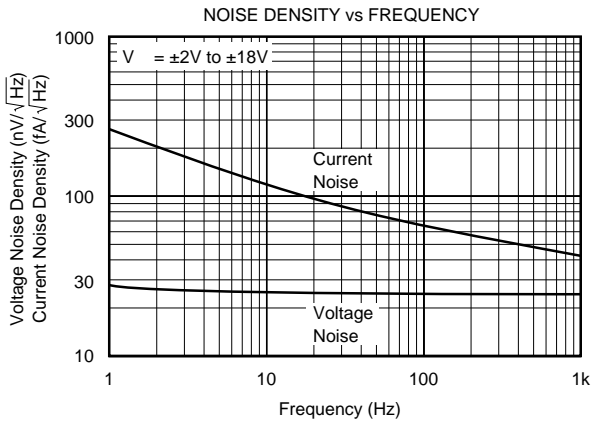

# TYPICAL PERFORMANCE CURVES (CONT)

$T_A = +25^\circ\text{C}$  unless otherwise noted.

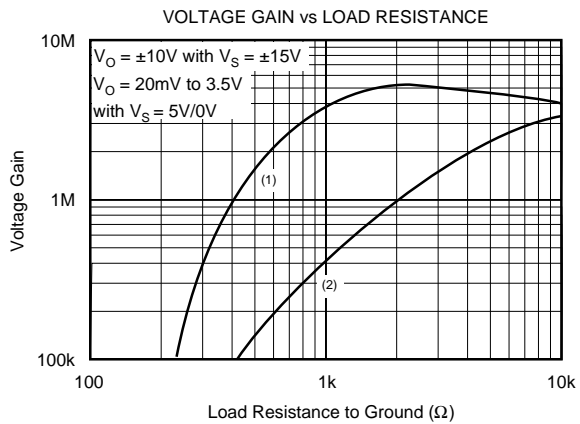
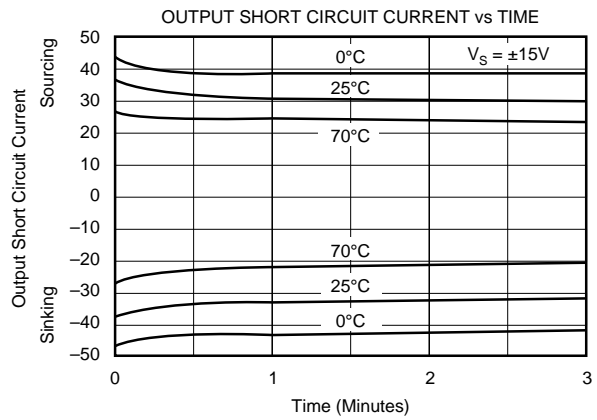
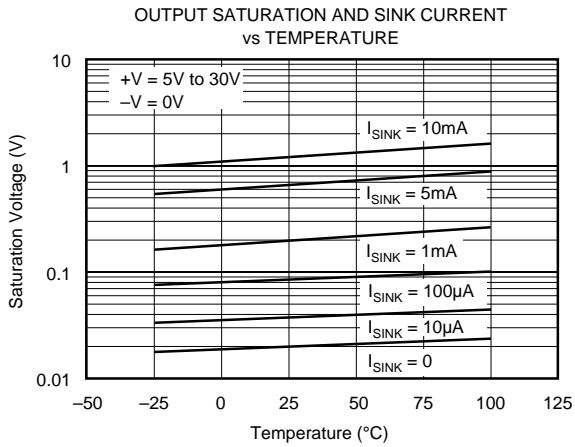

NOTES: (1)  $T_A = +25^\circ\text{C}$ ,  $V_S = \pm 15\text{V}$ . (2)  $T_A = +25^\circ\text{C}$ ,  $V_S = 5\text{V}/0\text{V}$ .

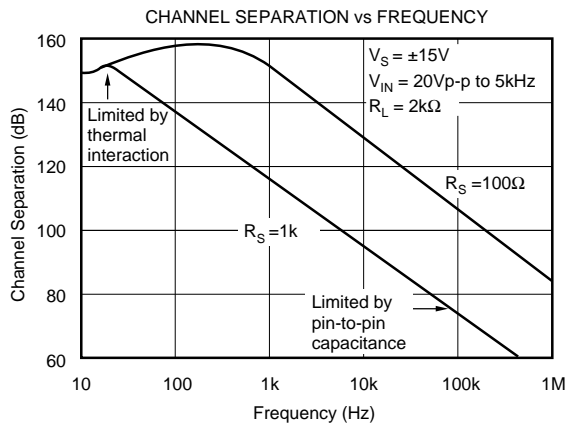
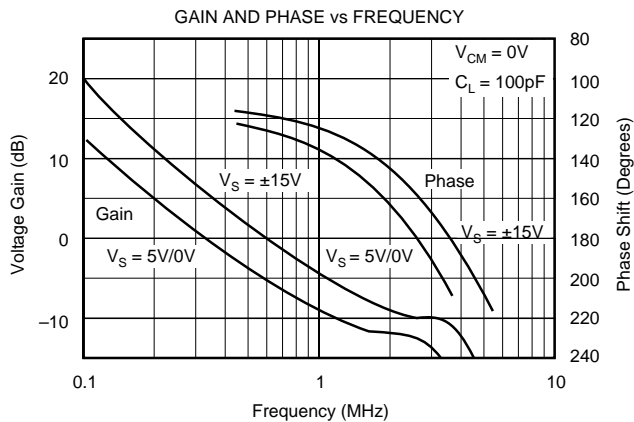
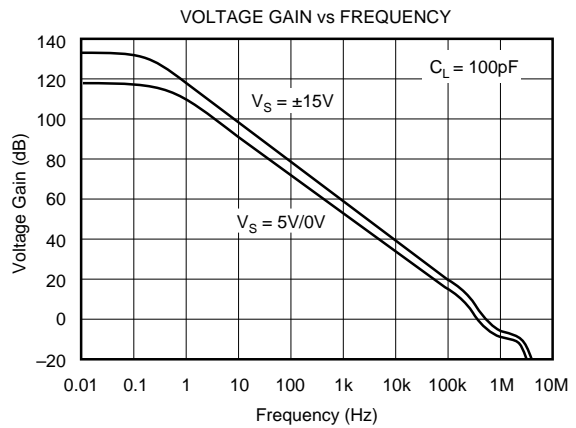

# TYPICAL PERFORMANCE CURVES (CONT)

SMALL SIGNAL TRANSIENT RESPONSE  
 $V_S = \pm 15V, G = +1$

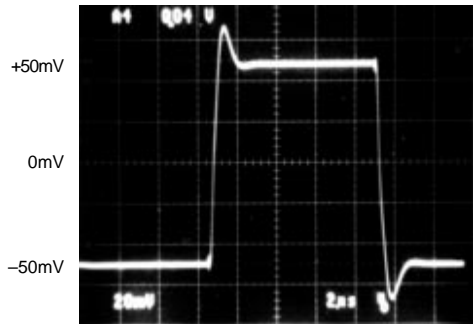

$V_S = 5V/0V$

LARGE SIGNAL TRANSIENT RESPONSE  
 $V_S = \pm 15V, G = +1$

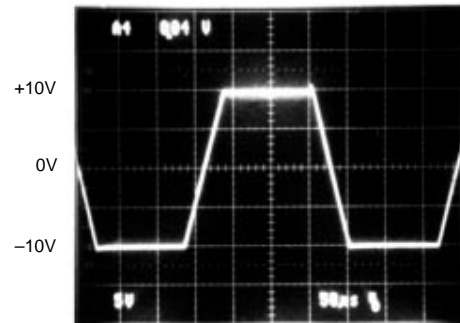

SMALL SIGNAL TRANSIENT RESPONSE  
 $V_S = 5V/0V, G = +1, R_L = 600\Omega$  to Ground

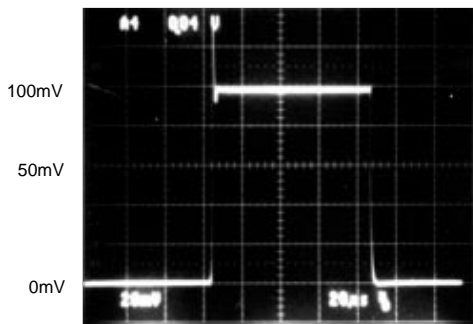

LARGE SIGNAL TRANSIENT RESPONSE  
 $V_S = 5V/0V, G = +1, R_L = 4.7kV$  to 5V

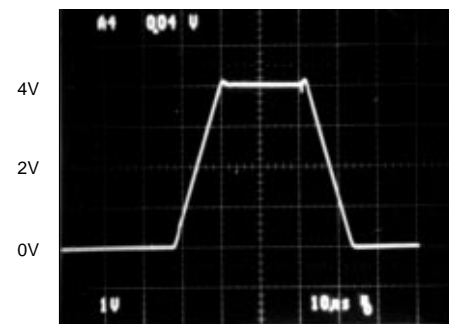

Input = 0V to 4V Pulse

LARGE SIGNAL TRANSIENT RESPONSE  
 $V_S = 5V/0V, G = +1, \text{No Load}$

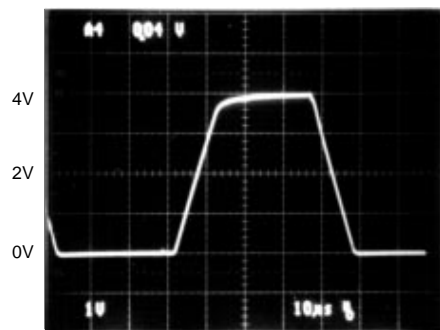

Input = 0V to 4V Pulse

COMPARATOR RISE RESPONSE TIME  
 10mV, 5mV, 2mV Overdrives

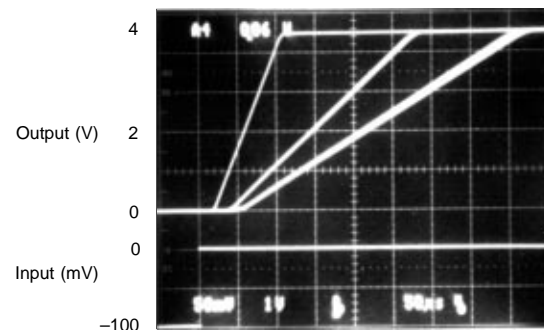

$V_S = 5V/0V$

# TYPICAL PERFORMANCE CURVES (CONT)

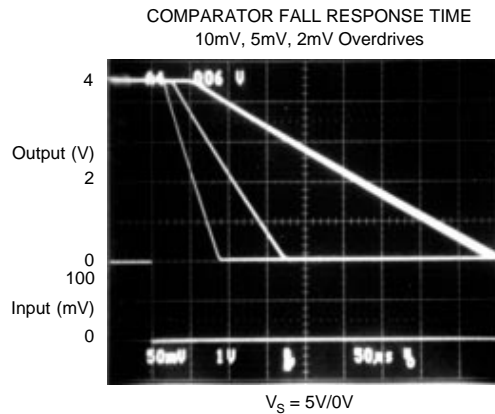

## APPLICATIONS INFORMATION

The OPA1013 is unity-gain stable, making it easy to use and free from oscillations in the widest range of circuitry. Follow good design practice by bypassing the power supplies close to the op amp pins. In most cases 0.1 $\mu$ F ceramic capacitors are adequate.

### SINGLE POWER SUPPLY OPERATION

The OPA1013 is specified for operation from a single power supply. This means that linear operation continues with the input terminals at (or even somewhat below) ground potential. When used in a non-inverting amplifier, 0V input must produce 0V output. In practice, the output swing is limited to approximately 15mV above ground with no load. Output swing near ground can be optimized when the output load is connected to ground. If the output must sink current, the ability to swing near ground will be diminished. The output swings to within approximately 200mV of ground when sinking 1mA.

### INPUT PROTECTION

The circuitry of the OPA1013 is protected against overload for input voltages ranging from the positive supply voltage to 5V below the negative supply voltage (below ground in single supply operation). No external protection circuitry is required, as it is with other common single-supply op amps.

Furthermore, the OPA1013 is free from phase-reversal problems common with other single-supply op amps. When the inputs are driven below ground (or below the negative power supply), the output polarity remains correct.

### COMPARATOR OPERATION

The OPA1013 functions well as a comparator, where high speed is not required. Sometimes, in fact, the low offset and docile characteristics of the OPA1013 may simplify the design of comparator circuitry. The two op amps in the OPA1013 use completely independent bias circuitry to avoid interaction when the inputs are over-driven. Driving one op amp into saturation will not affect the characteristics of the other amplifier. The outputs of the OPA1013 can drive one TTL load. Quiescent current remains stable when the inputs are overdriven.

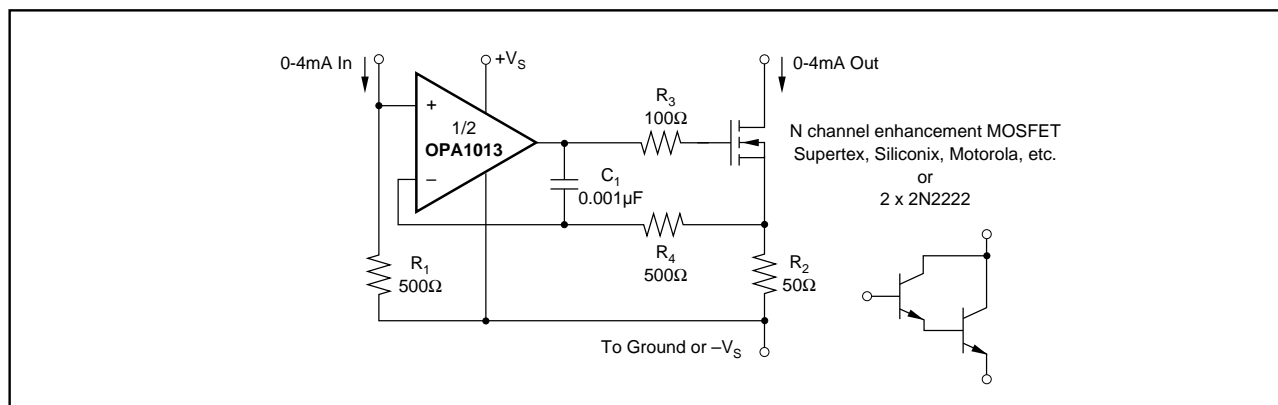

FIGURE 1. Precision Current Mirror.



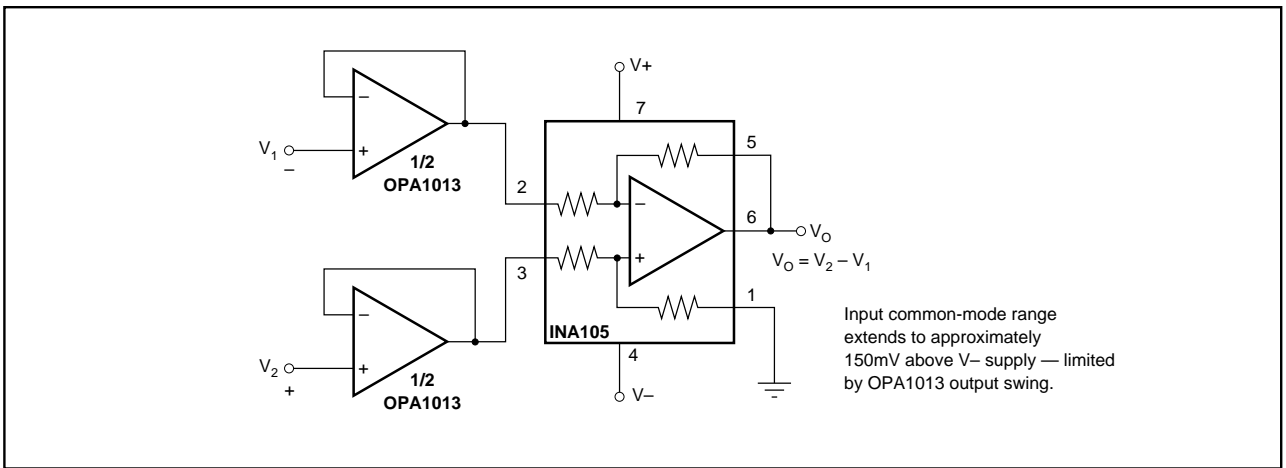

FIGURE 2. Instrumentation Amplifier.

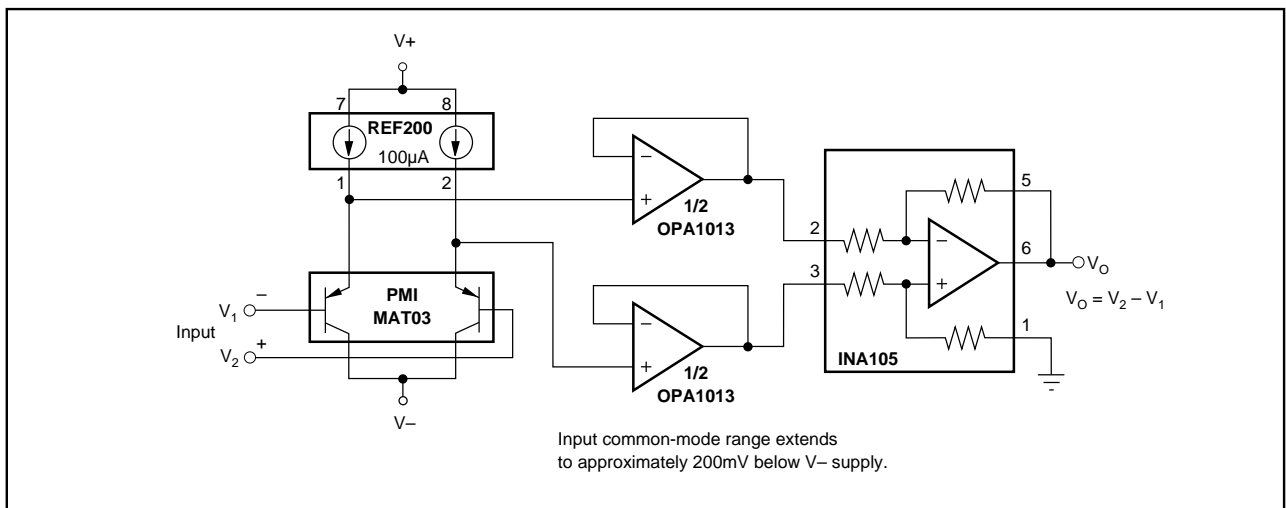

FIGURE 3. Instrumentation Amplifier.

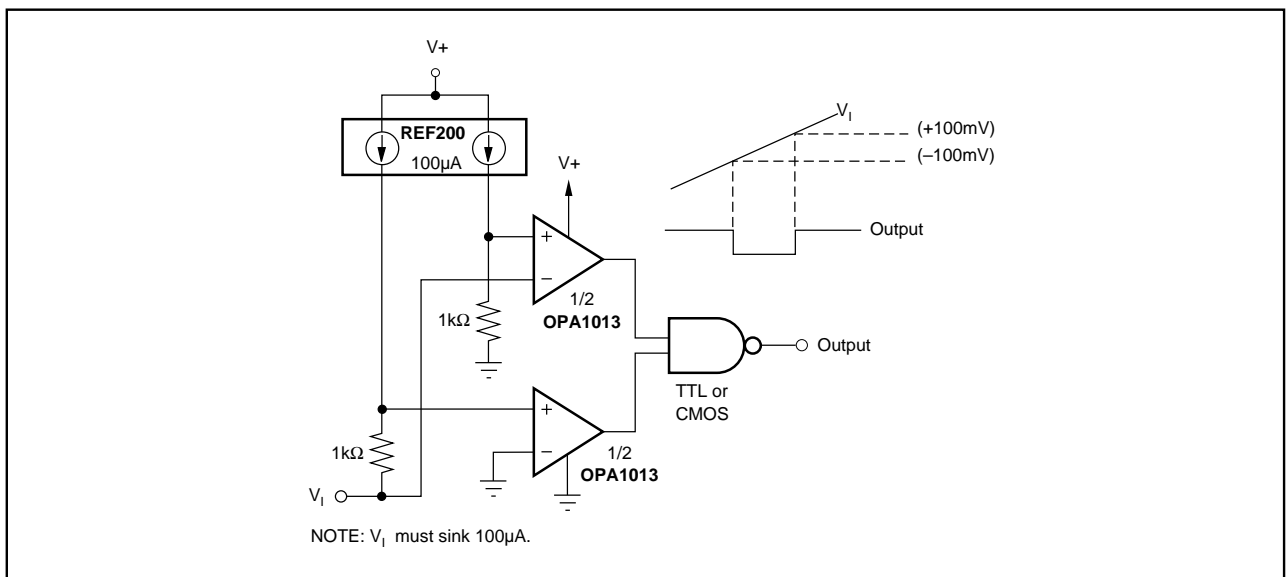

FIGURE 4. Window Comparator.

## **IMPORTANT NOTICE**

Texas Instruments and its subsidiaries (TI) reserve the right to make changes to their products or to discontinue any product or service without notice, and advise customers to obtain the latest version of relevant information to verify, before placing orders, that information being relied on is current and complete. All products are sold subject to the terms and conditions of sale supplied at the time of order acknowledgment, including those pertaining to warranty, patent infringement, and limitation of liability.

TI warrants performance of its semiconductor products to the specifications applicable at the time of sale in accordance with TI's standard warranty. Testing and other quality control techniques are utilized to the extent TI deems necessary to support this warranty. Specific testing of all parameters of each device is not necessarily performed, except those mandated by government requirements.

Customers are responsible for their applications using TI components.

In order to minimize risks associated with the customer's applications, adequate design and operating safeguards must be provided by the customer to minimize inherent or procedural hazards.

TI assumes no liability for applications assistance or customer product design. TI does not warrant or represent that any license, either express or implied, is granted under any patent right, copyright, mask work right, or other intellectual property right of TI covering or relating to any combination, machine, or process in which such semiconductor products or services might be or are used. TI's publication of information regarding any third party's products or services does not constitute TI's approval, warranty or endorsement thereof.