

# NYC222STT1G, NYC226STT1G, NYC228STT1G



ON Semiconductor®

<http://onsemi.com>

## Sensitive Gate Silicon Controlled Rectifiers

### Reverse Blocking Thyristors

Designed and tested for repetitive peak operation required for CD ignition, fuel ignitors, flash circuits, motor controls and low-power switching applications.

#### Features

- Blocking Voltage to 600 V
- High Surge Current – 15 A
- Very Low Forward “On” Voltage at High Current
- Low-Cost Surface Mount SOT–223 Package
- These are Pb–Free Devices

#### MAXIMUM RATINGS (T<sub>J</sub> = 25°C unless otherwise noted)

Rating	Symbol	Value	Unit
Peak Repetitive Off–State Voltage (Note 1) (R <sub>GK</sub> = 1K, T <sub>J</sub> = –40 to +110°C, Sine Wave, 50 to 60 Hz, Gate Open)	V <sub>DRM</sub> , V <sub>RRM</sub>	50 400 600	V
On-State Current RMS (180° Conduction Angles, T <sub>C</sub> = 80°C)	I <sub>T(RMS)</sub>	1.5	A
Peak Non-repetitive Surge Current, @T <sub>A</sub> = 25°C, (1/2 Cycle, Sine Wave, 60 Hz)	I <sub>TSM</sub>	15	A
Circuit Fusing Considerations (t = 8.3 ms)	I <sup>2</sup> t	0.9	A <sup>2</sup> s
Forward Peak Gate Power (Pulse Width ≤ 1.0 μsec, T <sub>A</sub> = 25°C)	P <sub>GM</sub>	0.5	W
Forward Average Gate Power (t = 8.3 msec, T <sub>A</sub> = 25°C)	P <sub>G(AV)</sub>	0.1	W
Forward Peak Gate Current (Pulse Width ≤ 1.0 μs, T <sub>A</sub> = 25°C)	I <sub>FGM</sub>	0.2	A
Reverse Peak Gate Voltage (Pulse Width ≤ 1.0 μs, T <sub>A</sub> = 25°C)	V <sub>RGM</sub>	5.0	V
Operating Junction Temperature Range @ Rated V <sub>RRM</sub> and V <sub>DRM</sub>	T <sub>J</sub>	–40 to +110	°C
Storage Temperature Range	T <sub>stg</sub>	–40 to +150	°C

Stresses exceeding Maximum Ratings may damage the device. Maximum Ratings are stress ratings only. Functional operation above the Recommended Operating Conditions is not implied. Extended exposure to stresses above the Recommended Operating Conditions may affect device reliability.

1. V<sub>DRM</sub> and V<sub>RRM</sub> for all types can be applied on a continuous basis. Ratings apply for zero or negative gate voltage; however, positive gate voltage shall not be applied concurrent with negative potential on the anode. Blocking voltages shall not be tested with a constant current source such that the voltage ratings of the devices are exceeded.

SCRs  
1.5 AMPERES RMS  
400 thru 600 VOLTS



#### MARKING DIAGRAM



SOT–223  
CASE 318E  
STYLE 11

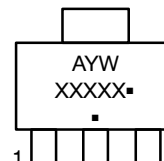

A = Assembly Location  
Y = Year  
W = Work Week  
XXXXX = Device Code  
▪ = Pb–Free Package

(Note: Microdot may be in either location)

#### PIN ASSIGNMENT

Pin	Assignment
1	K (Cathode)
2	A (Anode)
3	G (Gate)
4	A (Anode)

#### ORDERING INFORMATION

Device	Package	Shipping†
NYC222STT1G	SOT–223 (Pb–Free)	1000 /Tape & Reel
NYC226STT1G	SOT–223 (Pb–Free)	1000 /Tape & Reel
NYC228STT1G	SOT–223 (Pb–Free)	1000 /Tape & Reel

†For information on tape and reel specifications, including part orientation and tape sizes, please refer to our Tape and Reel Packaging Specification Brochure, BRD8011/D.

# NYC222STT1G, NYC226STT1G, NYC228STT1G

## THERMAL CHARACTERISTICS

Characteristic	Symbol	Max	Unit
Thermal Resistance, Junction-to-Ambient PCB Mounted	$R_{\theta JA}$	156	$^{\circ}C/W$
Thermal Resistance, Junction-to-Tab Measured on MT2 Tab Adjacent to Epoxy	$R_{\theta JT}$	25	$^{\circ}C/W$
Maximum Device Temperature for Soldering Purposes for 10 Secs Maximum	$T_L$	260	$^{\circ}C$

## ELECTRICAL CHARACTERISTICS ( $T_C = 25^{\circ}C$ unless otherwise noted.)

Characteristic	Symbol	Min	Typ	Max	Unit
----------------	--------	-----	-----	-----	------

### OFF CHARACTERISTICS

Peak Repetitive Forward or Reverse Blocking Current ( $V_{AK} = \text{Rated } V_{DRM}/V_{RRM}$ ; $R_{GK} = 1000 \Omega$ )	$I_{DRM}, I_{RRM}$	$T_C = 25^{\circ}C$	-	-	10	$\mu A$
		$T_C = 110^{\circ}C$	-	-	200	$\mu A$

### ON CHARACTERISTICS

Peak Forward On-State Voltage (Note 2) ( $I_{TM} = 2.2 \text{ A Peak}$ )	$V_{TM}$	-	1.2	1.7	V	
Gate Trigger Current (dc) (Note 3) ( $V_{AK} = 7 \text{ Vdc}$ , $R_L = 100 \Omega$ )	$I_{GT}$	$T_C = 25^{\circ}C$	-	30	200	$\mu A$
		$T_C = -40^{\circ}C$	-	-	500	
Gate Trigger Voltage (dc) (Note 3) ( $V_{AK} = 7 \text{ Vdc}$ , $R_L = 100 \Omega$ )	$V_{GT}$	$T_C = 25^{\circ}C$	-	-	0.8	V
		$T_C = -40^{\circ}C$	-	-	1.2	
Gate Non-Trigger Voltage ( $V_{AK} = V_{DRM}$ , $R_L = 100 \Omega$ )	$V_{GD}$	0.1	-	-	V	
Holding Current ( $V_{AK} = 12 \text{ V}$ , $R_{GK} = 1000 \Omega$ ) Initiating Current = 200 mA	$I_H$	$T_C = 25^{\circ}C$	-	2.0	5.0	mA
		$T_C = -40^{\circ}C$	-	-	10	

### DYNAMIC CHARACTERISTICS

Critical Rate of Rise of Off-State Voltage ( $T_C = 110^{\circ}C$ )	$dv/dt$	-	25	-	V/ $\mu s$
--	---------	---	----	---	------------

2. Pulse Width = 1.0 ms, Duty Cycle  $\leq 1\%$ .
3.  $R_{GK}$  Current not included in measurement.

## Voltage Current Characteristic of SCR

Symbol	Parameter
$V_{DRM}$	Peak Repetitive Off State Forward Voltage
$I_{DRM}$	Peak Forward Blocking Current
$V_{RRM}$	Peak Repetitive Off State Reverse Voltage
$I_{RRM}$	Peak Reverse Blocking Current
$V_{TM}$	Peak on State Voltage
$I_H$	Holding Current

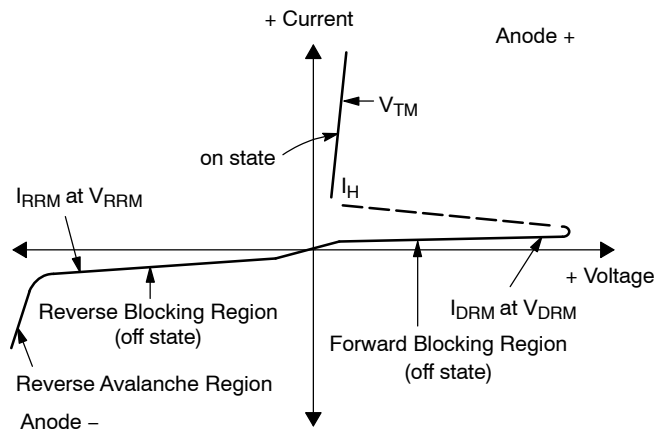

# NYC222STT1G, NYC226STT1G, NYC228STT1G

## CURRENT DERATING

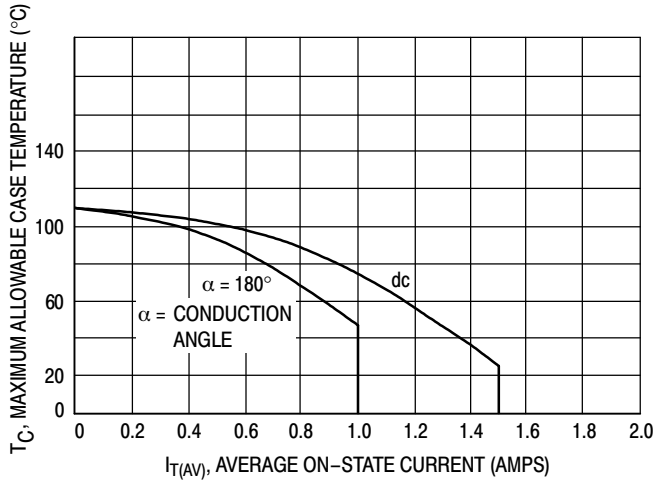

Figure 1. Maximum Case Temperature

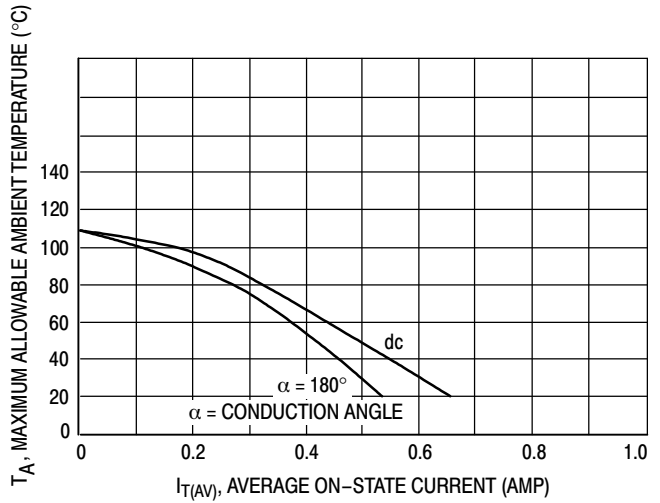

Figure 2. Maximum Ambient Temperature

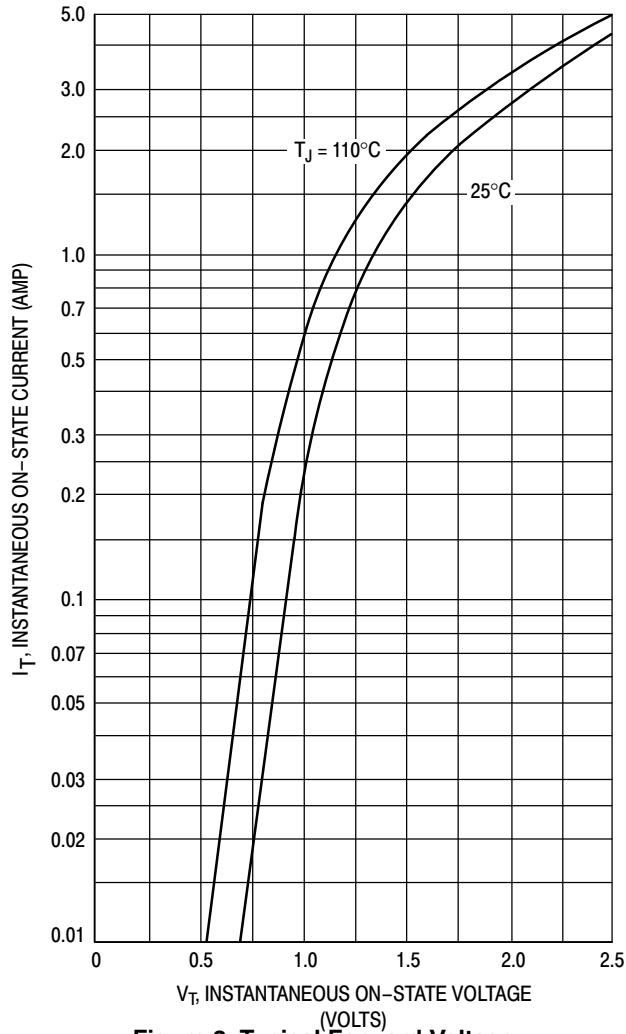

Figure 3. Typical Forward Voltage

NYC222STT1G, NYC226STT1G, NYC228STT1G

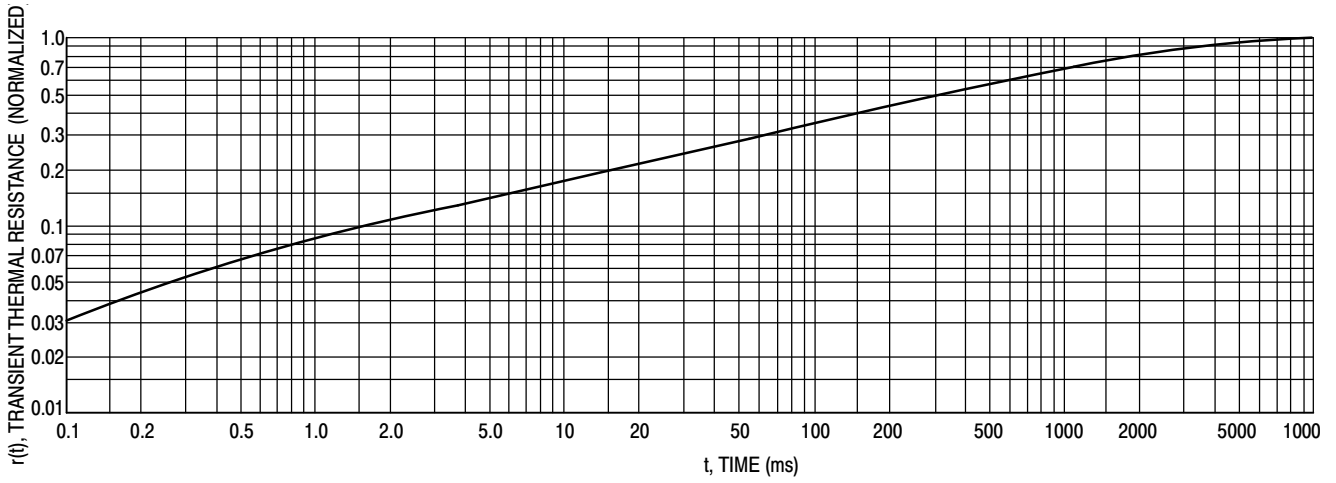

Figure 4. Thermal Response

TYPICAL CHARACTERISTICS

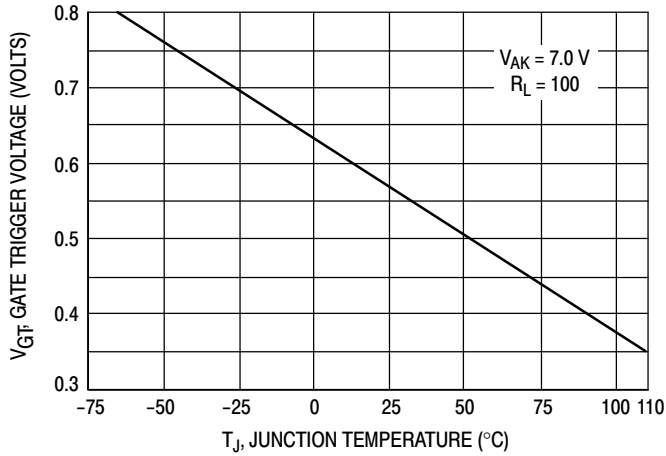

Figure 5. Typical Gate Trigger Voltage

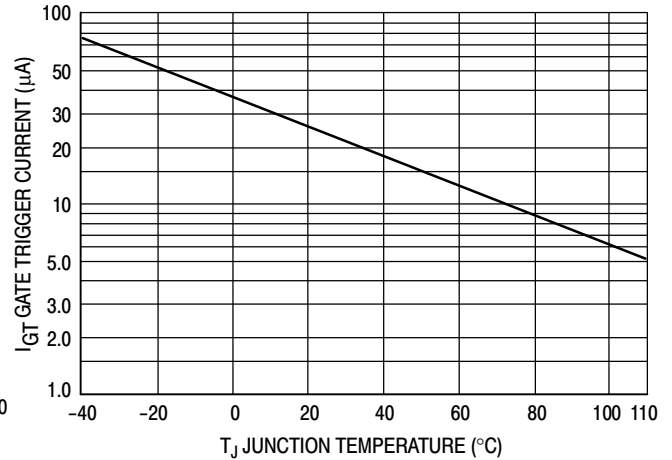

Figure 6. Typical Gate Trigger Current

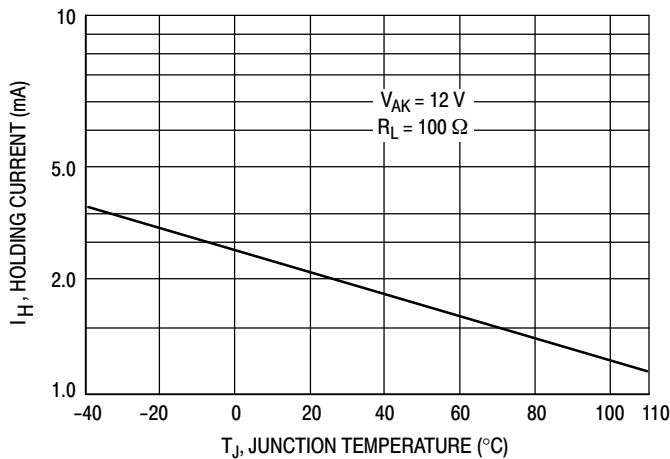

Figure 7. Typical Holding Current

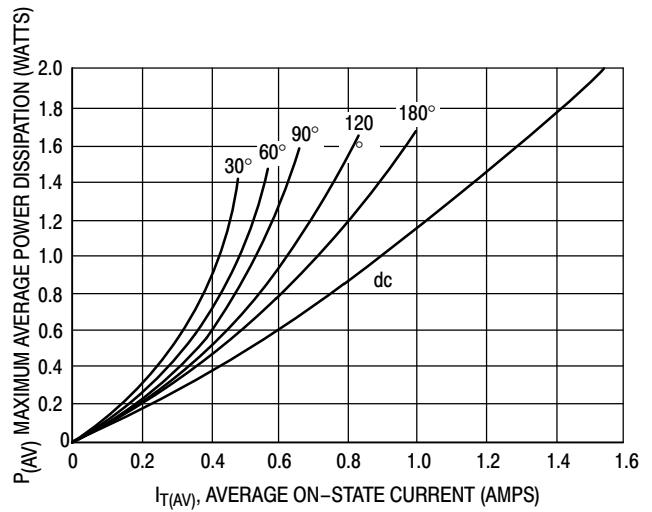
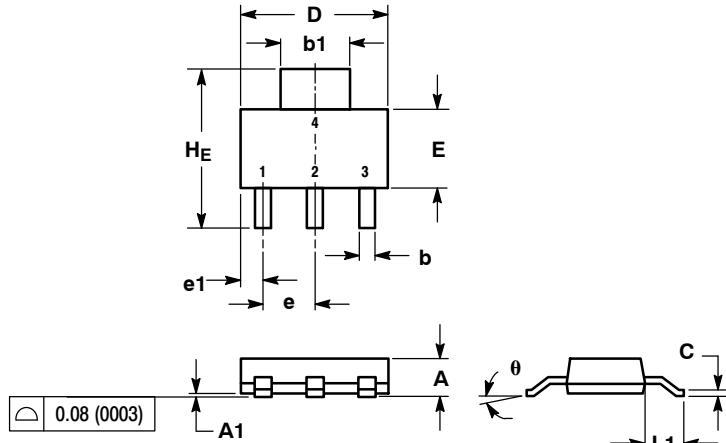

Figure 8. Power Dissipation

# NYC222STT1G, NYC226STT1G, NYC228STT1G

## PACKAGE DIMENSIONS

SOT-223 (TO-261)  
CASE 318E-04  
ISSUE M



NOTES:

1. DIMENSIONING AND TOLERANCING PER ANSI Y14.5M, 1982.
2. CONTROLLING DIMENSION: INCH.

DIM	MILLIMETERS			INCHES		
	MIN	NOM	MAX	MIN	NOM	MAX
A	1.50	1.63	1.75	0.060	0.064	0.068
A1	0.02	0.06	0.10	0.001	0.002	0.004
b	0.60	0.75	0.89	0.024	0.030	0.035
b1	2.90	3.06	3.20	0.115	0.121	0.126
c	0.24	0.29	0.35	0.009	0.012	0.014
D	6.30	6.50	6.70	0.249	0.256	0.263
E	3.30	3.50	3.70	0.130	0.138	0.145
e	2.20	2.30	2.40	0.087	0.091	0.094
e1	0.85	0.94	1.05	0.033	0.037	0.041
L1	1.50	1.75	2.00	0.060	0.069	0.078
HE	6.70	7.00	7.30	0.264	0.276	0.287
θ	0°	-	10°	0°	-	10°

STYLE 11:

1. MT 1
2. MT 2
3. GATE
4. MT 2

### SOLDERING FOOTPRINT\*

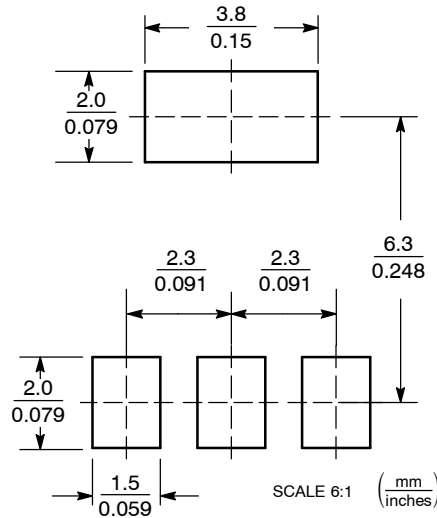

\*For additional information on our Pb-Free strategy and soldering details, please download the ON Semiconductor Soldering and Mounting Techniques Reference Manual, SOLDERRM/D.

ON Semiconductor and are registered trademarks of Semiconductor Components Industries, LLC (SCILLC). SCILLC reserves the right to make changes without further notice to any products herein. SCILLC makes no warranty, representation or guarantee regarding the suitability of its products for any particular purpose, nor does SCILLC assume any liability arising out of the application or use of any product or circuit, and specifically disclaims any and all liability, including without limitation special, consequential or incidental damages. "Typical" parameters which may be provided in SCILLC data sheets and/or specifications can and do vary in different applications and actual performance may vary over time. All operating parameters, including "Typicals" must be validated for each customer application by customer's technical experts. SCILLC does not convey any license under its patent rights nor the rights of others. SCILLC products are not designed, intended, or authorized for use as components in systems intended for surgical implant into the body, or other applications intended to support or sustain life, or for any other application in which the failure of the SCILLC product could create a situation where personal injury or death may occur. Should Buyer purchase or use SCILLC products for any such unintended or unauthorized application, Buyer shall indemnify and hold SCILLC and its officers, employees, subsidiaries, affiliates, and distributors harmless against all claims, costs, damages, and expenses, and reasonable attorney fees arising out of, directly or indirectly, any claim of personal injury or death associated with such unintended or unauthorized use, even if such claim alleges that SCILLC was negligent regarding the design or manufacture of the part. SCILLC is an Equal Opportunity/Affirmative Action Employer. This literature is subject to all applicable copyright laws and is not for resale in any manner.

### PUBLICATION ORDERING INFORMATION

**LITERATURE FULFILLMENT:**  
Literature Distribution Center for ON Semiconductor  
P.O. Box 5163, Denver, Colorado 80217 USA  
**Phone:** 303-675-2175 or 800-344-3860 Toll Free USA/Canada  
**Fax:** 303-675-2176 or 800-344-3867 Toll Free USA/Canada  
**Email:** orderlit@onsemi.com

**N. American Technical Support:** 800-282-9855 Toll Free USA/Canada  
**Europe, Middle East and Africa Technical Support:**  
Phone: 421 33 790 2910  
**Japan Customer Focus Center**  
Phone: 81-3-5773-3850

**ON Semiconductor Website:** [www.onsemi.com](http://www.onsemi.com)  
**Order Literature:** <http://www.onsemi.com/orderlit>

For additional information, please contact your local Sales Representative