

NL17SG32

Single 2-Input OR Gate

The NL17SG32 MiniGate™ is an advanced high-speed CMOS 2-input OR gate in ultra-small footprint.

The NL17SG32 input structures provides protection when voltages up to 4.6 V are applied.

Features

- Wide Operating V_{CC} Range: 0.9 V to 3.6 V
- High Speed: $t_{PD} = 2.4$ ns (Typ) at $V_{CC} = 3.0$ V, $C_L = 15$ pF
- Low Power Dissipation: $I_{CC} = 0.5$ μ A (Max) at $T_A = 25^\circ$ C
- 4.6 V Overvoltage Tolerant (OVT) Input Pins
- Ultra-Small Packages
- These are Pb-Free and Halide-Free Devices

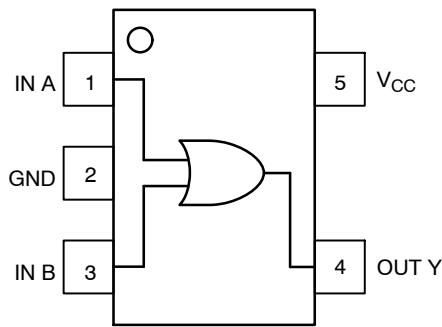

Figure 1. Pinout (Top View)

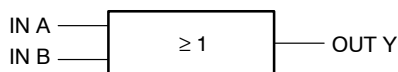

Figure 2. Logic Symbol



ON Semiconductor®

<http://onsemi.com>

MARKING DIAGRAM



3 = Specific Device Code
M = Month Code

PIN ASSIGNMENT

| | |
|---|----------|
| 1 | IN A |
| 2 | GND |
| 3 | IN B |
| 4 | OUT Y |
| 5 | V_{CC} |

FUNCTION TABLE

| Inputs | | Output |
|--------|---|--------|
| A | B | Y |
| L | L | L |
| L | H | H |
| H | L | H |
| H | H | H |

ORDERING INFORMATION

See detailed ordering and shipping information in the package dimensions section on page 5 of this data sheet.

NL17SG32

MAXIMUM RATINGS

| Symbol | Parameter | Value | Unit |
|---------------|---|--|------|
| V_{CC} | DC Supply Voltage | -0.5 to +5.5 | V |
| V_{IN} | DC Input Voltage | -0.5 to +5.5 | V |
| V_{OUT} | DC Output Voltage | -0.5 to $V_{CC} + 0.5$ | V |
| I_{IK} | DC Input Diode Current | $V_{IN} < GND$ -20 | mA |
| I_{OK} | DC Output Diode Current | $V_{OUT} < GND, V_{OUT} > V_{CC}$ ± 20 | mA |
| I_{OUT} | DC Output Source/Sink Current | ± 20 | mA |
| I_{CC} | DC Supply Current per Supply Pin | ± 20 | mA |
| I_{GND} | DC Ground Current per Ground Pin | ± 20 | mA |
| T_{STG} | Storage Temperature Range | -65 to +150 | °C |
| T_L | Lead Temperature, 1 mm from Case for 10 Seconds | 260 | °C |
| T_J | Junction Temperature Under Bias | +150 | °C |
| MSL | Moisture Sensitivity | Level 1 | |
| F_R | Flammability Rating | Oxygen Index: 28 to 34 UL 94 V-0 @ 0.125 in | |
| V_{ESD} | ESD Withstand Voltage | Human Body Model (Note 2) Machine Model (Note 3) >2000 >200 | V |
| $I_{LATCHUP}$ | Latchup Performance | Above V_{CC} and Below GND at 125°C (Note 4) ± 100 | mA |

Stresses exceeding Maximum Ratings may damage the device. Maximum Ratings are stress ratings only. Functional operation above the Recommended Operating Conditions is not implied. Extended exposure to stresses above the Recommended Operating Conditions may affect device reliability.

1. Measured with minimum pad spacing on an FR4 board, using 10 mm-by-1 inch, 2-ounce copper trace with no air flow.
2. Tested to EIA/JESD22-A114-A.
3. Tested to EIA/JESD22-A115-A.
4. Tested to EIA/JESD78.

RECOMMENDED OPERATING CONDITIONS

| Symbol | Characteristics | Min | Max | Unit |
|-----------------------|------------------------------------|-----|----------------------------------|------|
| V_{CC} | Positive DC Supply Voltage | 0.9 | 4.6 | V |
| V_{IN} | Digital Input Voltage | 0.0 | 4.6 | V |
| V_{OUT} | Output Voltage | 0.0 | V_{CC} | V |
| T_A | Operating Temperature Range | -55 | +125 | °C |
| $\Delta t / \Delta V$ | Input Transition Rise or Fall Rate | | $V_{CC} = 3.3 V \pm 0.3 V$ 10 | ns/V |

NL17SG32

DC ELECTRICAL CHARACTERISTICS

| Symbol | Parameter | Conditions | V _{CC} (V) | T _A = 25°C | | T _A = -55°C to +125°C | | Unit |
|-----------------|---------------------------|--|---------------------------|-----------------------|-----------------------|----------------------------------|-----------------------|------|
| | | | | Min | Max | Min | Max | |
| V _{IH} | High-Level Input Voltage | | 0.9 | V _{CC} | | V _{CC} | | V |
| | | | 1.1 to 1.3 | 0.7xV _{CC} | | 0.7xV _{CC} | | |
| | | | 1.4 to 1.6 | 0.65xV _{CC} | | 0.65xV _{CC} | | |
| | | | 1.65 to 1.95 | 0.65xV _{CC} | | 0.65xV _{CC} | | |
| | | | 2.3 to 2.7 | 1.7 | | 1.7 | | |
| | | | 3.0 to 3.6 | 2.0 | | 2.0 | | |
| V _{IL} | Low-Level Input Voltage | | 0.9 | | GND | | GND | V |
| | | | 1.1 to 1.3 | | 0.3xV _{CC} | | 0.3xV _{CC} | |
| | | | 1.4 to 1.6 | | 0.35xV _{CC} | | 0.35xV _{CC} | |
| | | | 1.65 to 1.95 | | 0.35xV _{CC} | | 0.35xV _{CC} | |
| | | | 2.3 to 2.7 | | 0.7 | | 0.7 | |
| | | | 3.0 to 3.6 | | 0.8 | | 0.8 | |
| V _{OH} | High-Level Output Voltage | V _{IN} = V _{IH} or V _{IL} | I _{OH} = -20 μA | 0.9 | 0.75 | | 0.75 | V |
| | | | I _{OH} = -0.3 mA | 1.1 to 1.3 | 0.75xV _{CC} | | 0.75xV _{CC} | |
| | | | I _{OH} = -1.7 mA | 1.4 to 1.6 | 0.75xV _{CC} | | 0.75xV _{CC} | |
| | | | I _{OH} = -3.0 mA | 1.65 to 1.95 | V _{CC} -0.45 | | V _{CC} -0.45 | |
| | | | I _{OH} = -4.0 mA | 2.3 to 2.7 | 2.0 | | 2.0 | |
| | | | I _{OH} = -8.0 mA | 3.0 to 3.6 | 2.48 | | 2.48 | |
| V _{OL} | Low-Level Output Voltage | V _{IN} = V _{IH} or V _{IL} | I _{OL} = 20 μA | 0.9 to 3.6 | | 0.1 | 0.1 | V |
| | | | I _{OL} = 1.1 mA | 1.1 to 1.3 | | 0.25xV _{CC} | 0.25xV _{CC} | |
| | | | I _{OL} = 1.7 mA | 1.4 to 1.6 | | 0.25xV _{CC} | 0.25xV _{CC} | |
| | | | I _{OL} = 3.0 mA | 1.65 to 1.95 | | 0.45 | 0.45 | |
| | | | I _{OL} = 4.0 mA | 2.3 to 2.7 | | 0.4 | 0.4 | |
| | | | I _{OL} = 8.0 mA | 3.0 to 3.6 | | 0.4 | 0.4 | |
| I _{IN} | Input Leakage Current | 0 ≤ V _{IN} ≤ 3.6 V | 0 to 3.6 | | ±0.1 | | ±1.0 | μA |
| I _{CC} | Quiescent Supply Current | V _{IN} = V _{CC} or GND | 3.6 | | 0.5 | | 10.0 | μA |

NL17SG32

AC ELECTRICAL CHARACTERISTICS Input $t_r = t_f = 3.0$ ns

| Symbol | Parameter | Test Condition | V_{CC} (V) | $T_A = 25^\circ\text{C}$ | | | $T_A = -55^\circ\text{C to } +125^\circ\text{C}$ | | Unit |
|--------------------------|---|--|--------------|--------------------------|------|------|--|------|------|
| | | | | Min | Typ | Max | Min | Max | |
| t_{PLH} , t_{PHL} | Propagation Delay, A or B to Y | $C_L = 10$ pF, $R_L = 1$ M Ω | 0.9 | - | 12.2 | 14.4 | - | 18.0 | ns |
| | | | 1.1 to 1.3 | - | 8.8 | 12.4 | - | 16.2 | |
| | | | 1.4 to 1.6 | - | 5.0 | 8.5 | - | 10.0 | |
| | | | 1.65 to 1.95 | - | 3.6 | 6.2 | - | 6.7 | |
| | | | 2.3 to 2.7 | - | 2.7 | 3.9 | - | 4.4 | |
| | | | 3.0 to 3.6 | - | 2.1 | 3.1 | - | 3.7 | |
| | | $C_L = 15$ pF, $R_L = 1$ M Ω | 0.9 | - | 13.0 | 16.0 | - | 18.0 | ns |
| | | | 1.1 to 1.3 | - | 7.8 | 12.0 | - | 16.0 | |
| | | | 1.4 to 1.6 | - | 5.9 | 9.3 | - | 11.2 | |
| | | | 1.65 to 1.95 | - | 4.5 | 6.9 | - | 7.1 | |
| | | | 2.3 to 2.7 | - | 3.0 | 4.4 | - | 5.0 | |
| | | | 3.0 to 3.6 | - | 2.4 | 3.4 | - | 3.9 | |
| | | $C_L = 30$ pF, $R_L = 1$ M Ω | 0.9 | - | 14.0 | 17.2 | - | 20.0 | ns |
| | | | 1.1 to 1.3 | - | 11.0 | 14.1 | - | 17.8 | |
| | | | 1.4 to 1.6 | - | 8.0 | 12.1 | - | 15.9 | |
| | | | 1.65 to 1.95 | - | 6.0 | 9.2 | - | 9.6 | |
| | | | 2.3 to 2.7 | - | 3.9 | 5.7 | - | 6.1 | |
| | | | 3.0 to 3.6 | - | 3.0 | 4.4 | - | 4.8 | |
| C_{IN} | Input Capacitance | | 0 to 3.6 | | 3 | - | - | pF | |
| C_{PD} | Power Dissipation Capacitance (Note 5) | $f = 10$ MHz | 0.9 to 3.6 | - | 4 | - | - | pF | |

5. C_{PD} is defined as the value of the internal equivalent capacitance which is calculated from the operating current consumption without load. Average operating current can be obtained by the equation: $I_{CC(OPR)} = C_{PD} \cdot V_{CC} \cdot f_{in} + I_{CC}$. C_{PD} is used to determine the no-load dynamic power consumption; $P_D = C_{PD} \cdot V_{CC}^2 \cdot f_{in} + I_{CC} \cdot V_{CC}$.

NL17SG32

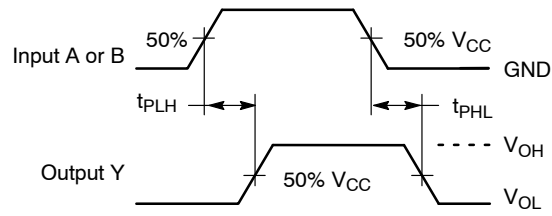
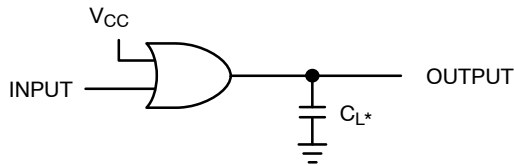

Figure 3. Switching Waveforms



*Includes all probe and jig capacitance.
A 1-MHz square input wave is recommended for propagation delay tests.

Figure 4. Test Circuit

ORDERING INFORMATION

| Device | Package | Shipping [†] |
|---------------|----------------------|-----------------------|
| NL17SG32P5T5G | SOT-953 (Pb-Free) | 8000 / Tape & Reel |

[†]For information on tape and reel specifications, including part orientation and tape sizes, please refer to our Tape and Reel Packaging Specifications Brochure, BRD8011/D.

NL17SG32

PACKAGE DIMENSIONS

SOT-953
CASE 527AE
ISSUE E

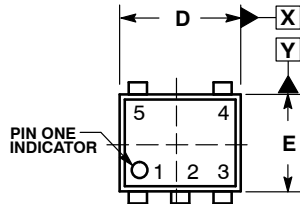

TOP VIEW

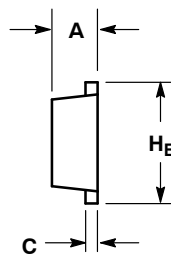

SIDE VIEW

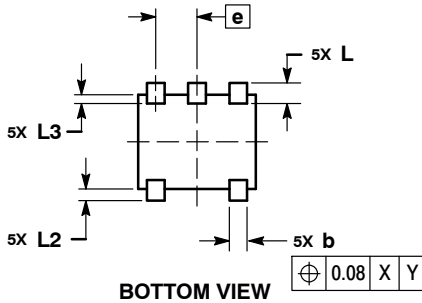

BOTTOM VIEW

NOTES:

1. DIMENSIONING AND TOLERANCING PER ASME Y14.5M, 1994.
2. CONTROLLING DIMENSION: MILLIMETERS
3. MAXIMUM LEAD THICKNESS INCLUDES LEAD FINISH. MINIMUM LEAD THICKNESS IS THE MINIMUM THICKNESS OF THE BASE MATERIAL.
4. DIMENSIONS D AND E DO NOT INCLUDE MOLD FLASH, PROTRUSIONS, OR GATE BURRS.

| DIM | MILLIMETERS | | |
|----------------|-------------|------|------|
| | MIN | NOM | MAX |
| A | 0.34 | 0.37 | 0.40 |
| b | 0.10 | 0.15 | 0.20 |
| C | 0.07 | 0.12 | 0.17 |
| D | 0.95 | 1.00 | 1.05 |
| E | 0.75 | 0.80 | 0.85 |
| e | 0.35 BSC | | |
| H _E | 0.95 | 1.00 | 1.05 |
| L | 0.175 REF | | |
| L2 | 0.05 | 0.10 | 0.15 |
| L3 | --- | --- | 0.15 |

SOLDERING FOOTPRINT*

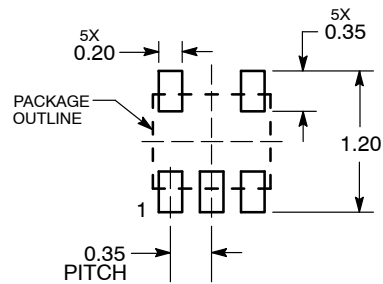

DIMENSIONS: MILLIMETERS

*For additional information on our Pb-Free strategy and soldering details, please download the ON Semiconductor Soldering and Mounting Techniques Reference Manual, SOLDERRM/D.

MiniGate is a trademark of Semiconductor Components Industries, LLC (SCILLC).

ON Semiconductor and are registered trademarks of Semiconductor Components Industries, LLC (SCILLC). SCILLC reserves the right to make changes without further notice to any products herein. SCILLC makes no warranty, representation or guarantee regarding the suitability of its products for any particular purpose, nor does SCILLC assume any liability arising out of the application or use of any product or circuit, and specifically disclaims any and all liability, including without limitation special, consequential or incidental damages. "Typical" parameters which may be provided in SCILLC data sheets and/or specifications can and do vary in different applications and actual performance may vary over time. All operating parameters, including "Typicals" must be validated for each customer application by customer's technical experts. SCILLC does not convey any license under its patent rights nor the rights of others. SCILLC products are not designed, intended, or authorized for use as components in systems intended for surgical implant into the body, or other applications intended to support or sustain life, or for any other application in which the failure of the SCILLC product could create a situation where personal injury or death may occur. Should Buyer purchase or use SCILLC products for any such unintended or unauthorized application, Buyer shall indemnify and hold SCILLC and its officers, employees, subsidiaries, affiliates, and distributors harmless against all claims, costs, damages, and expenses, and reasonable attorney fees arising out of, directly or indirectly, any claim of personal injury or death associated with such unintended or unauthorized use, even if such claim alleges that SCILLC was negligent regarding the design or manufacture of the part. SCILLC is an Equal Opportunity/Affirmative Action Employer. This literature is subject to all applicable copyright laws and is not for resale in any manner.

PUBLICATION ORDERING INFORMATION

LITERATURE FULFILLMENT:
Literature Distribution Center for ON Semiconductor
P.O. Box 5163, Denver, Colorado 80217 USA
Phone: 303-675-2175 or 800-344-3860 Toll Free USA/Canada
Fax: 303-675-2176 or 800-344-3867 Toll Free USA/Canada
Email: orderlit@onsemi.com

N. American Technical Support: 800-282-9855 Toll Free
USA/Canada
Europe, Middle East and Africa Technical Support:
Phone: 421 33 790 2910
Japan Customer Focus Center
Phone: 81-3-5817-1050

ON Semiconductor Website: www.onsemi.com

Order Literature: <http://www.onsemi.com/orderlit>

For additional information, please contact your local Sales Representative