

# NCV-RSL10

## Product Preview

# Bluetooth® 5 Radio System-on-Chip (SoC) for Automotive

### Introduction

A member of the RSL10 product family, NCV-RSL10 brings the industry's lowest power Bluetooth low energy technology to the automotive industry. NCV-RSL10 helps enable advanced new functionality including keyless entry using a fob or smartphone, active safety and diagnostic alerts, and enhanced infotainment controls while maximizing energy efficiency.

The Bluetooth 5 certified radio SoC supports 2 Mbps data rates, twice the speed possible with previous Bluetooth generations. Specially designed and qualified for the unique needs of automotive, NCV-RSL10 features built-in data encryption, wettable flank-plated packaging, and a higher operating temperature range.

### Key Features

- Automotive Ready
  - ◆ AEC-Q100 Grade 2, ETSI, FCC Qualified
  - ◆ Operating Temperature Range (-40°C to +105°C)
- Advanced Wireless Functionality
  - ◆ Bluetooth 5 Certified with Support for 2 Mbps Data Rates
  - ◆ Transmitting Power: -17 dBm to +6 dBm
  - ◆ Rx Sensitivity (Bluetooth Low Energy Mode, 1 Mbps): -94 dBm
- Enhanced Security
  - ◆ Built-in AES128 encryption accelerator
- Industry's Lowest Power Consumption
  - ◆ Tx peak (PHY) @ 0 dBm: 4.3 mA (3.3 V Supply)
  - ◆ Rx peak (PHY): 2.7 mA (3.3 V Supply)
  - ◆ Deep Sleep, I/O Wake-up (3.3 V Supply): 25 nA
  - ◆ Deep Sleep, Active External 32 kHz oscillator (3.3 V Supply): 40 nA
- Reliable Assembly
  - ◆ Wettable flank-plated WQFNW48, 7x7 mm package
- Highly-Integrated System-on-Chip (SoC)
  - ◆ 384 kB of Flash Memory
  - ◆ Flexible Dual-Core architecture (Arm(R) Cortex-M3 processor, 32-bit DSP)

### Other Specifications

- Data Rate: 62.5 to 2000 kbps
- Flexible Supply Voltage Range (1.1-3.3 V)
- Supports Firmware Over-The-Air (FOTA) updates

This document contains information on a product under development. ON Semiconductor reserves the right to change or discontinue this product without notice.



ON Semiconductor®

[www.onsemi.com](http://www.onsemi.com)

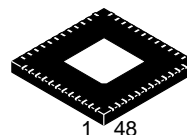

WQFNW48  
CASE 512AD

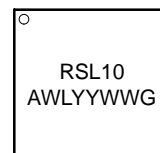

(WQFNW48)

A = Assembly Location  
WL = Wafer Lot  
YY = Year  
WW = Work Week  
G = Pb-Free Package

### ORDERING INFORMATION

Device	Package	Shipping†
NCV-RSL10-101Q48-AVG	WQFNW48 (Pb-Free)	3000 / Tape & Reel

†For information on tape and reel specifications, including part orientation and tape sizes, please refer to our Tape and Reel Packaging Specification Brochure, BRD8011/D.

## FEATURES

- **Arm Cortex–M3 Processor:** A 32–bit core for real–time applications, specifically developed to enable high–performance low–cost platforms for a broad range of low–power applications.
- **LPDSP32:** A 32–bit Dual Harvard DSP core that efficiently supports custom crypto graphic algorithms or other signal processing that require significant number crunching.
- **Radio Frequency Front–End:** Based on a 2.4 GHz RF transceiver, the RFFE implements the physical layer of the Bluetooth low energy technology standard and other proprietary or custom protocols.
- **Protocol Baseband Hardware:** Bluetooth 5 certified and includes support for a 2 Mbps RF link and custom protocol options. The RSL10 baseband stack is supplemented by support structures that enable implementation of ON Semiconductor and customer designed custom protocols.
- **Highly–Integrated SoC:** The dual–core architecture is complemented by high–efficiency power management units, oscillators, flash and RAM memories, a DMA controller, along with a full complement of peripherals and interfaces.
- **Deep Sleep Mode:** RSL10 can be put into a Deep Sleep Mode when no operations are required. Various Deep Sleep Mode configurations are available, including:
  - ◆ “IO wake–up” configuration. The power consumption in deep sleep mode is 25 nA (3.3 V VBAT).
  - ◆ Embedded 32 kHz oscillator running with interrupts from timer or external pin. The total current drain is 40 nA (3.3 V VBAT).
  - ◆ As above with 8 kB RAM data retention. The total current drain is 150 nA (3.3 V VBAT).
  - ◆ With the exception of IO wake up only configuration, the on–chip buck converter can also be enabled to reduce current consumption in Deep Sleep Mode.
- **Standby Mode:** Can be used to reduce the average power consumption for off–duty cycle operation, ranging typically from a few ms to a few hundreds of ms. The typical chip power consumption is 30  $\mu$ A in Standby Mode.
- **Multi–Protocol Support:** Using the flexibility provided by LPDSP32, the Arm Cortex–M3 processor, and the RF front–end; proprietary protocols and other custom protocols are supported.
- **Flexible Supply Voltage:** RSL10 integrates high–efficiency power regulators and has a VBAT range of 1.1 to 3.3 V.
- **Highly Configurable Interfaces:** I<sup>2</sup>C, UART, two SPI interfaces, PCM interface, multiple GPIOs.
- **Flexible Clocking Scheme:** RSL10 must be clocked from the XTAL/PLL of the radio front–end at 48 MHz when transmitting or receiving RF traffic. When RSL10 is not transmitting/receiving RF traffic, it can run off the 48 MHz XTAL, the internal RC oscillators, the 32 kHz oscillator, or an external clock. A low frequency RTC clock at 32 kHz can also be used in Deep Sleep Mode. It can be sourced from either the internal XTAL, the RC oscillator, or a digital input pad.
- **Diverse Memory Architecture:** 76 kB of SRAM program memory and 88 kB of SRAM data memory are available. A total of 384 kB of flash is available to store the Bluetooth stack and other applications. The Arm Cortex–M3 processor can execute from SRAM and/or flash.
- **IP Protection Feature:** Ensures that the customer’s flash contents cannot be copied by a third party. It prevents any core or memory from being accessed externally after the chip has booted.
- **RoHS Compliant device**

# NCV-RSL10

## RSL10 INTERNAL BLOCK DIAGRAM

The block diagram of the RSL10 chip is shown in Figure 1.

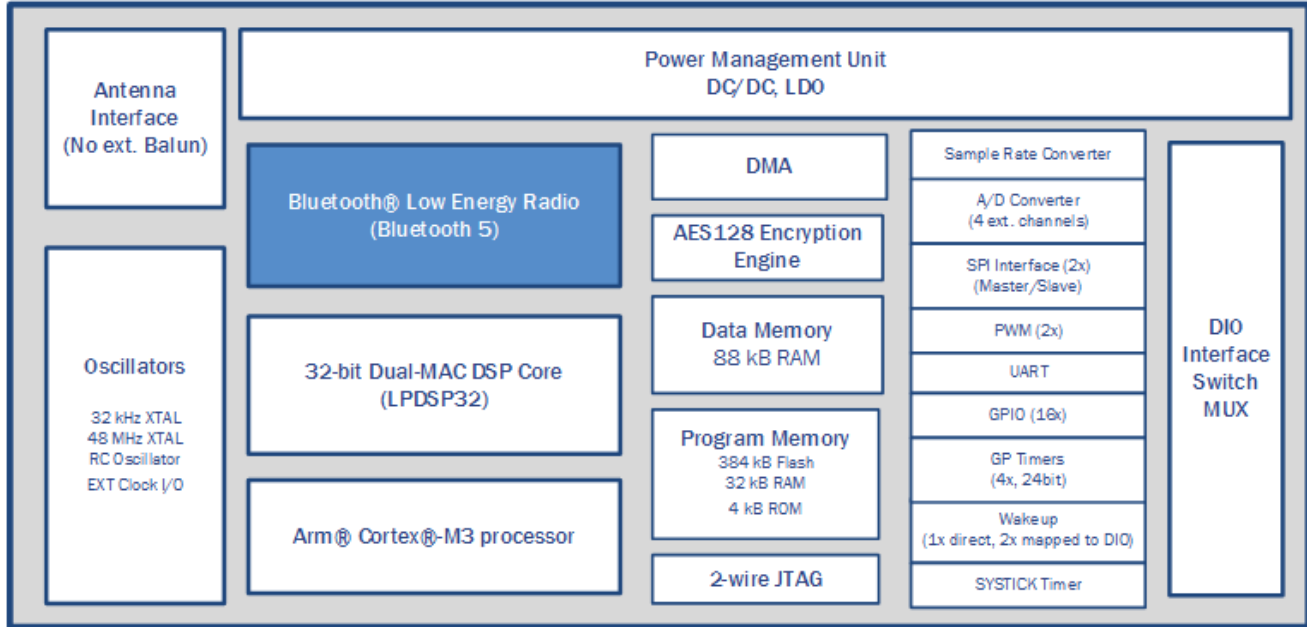

Figure 1. RSL10 Block Diagram

Table 1. ABSOLUTE MAXIMUM RATINGS

Symbol	Parameter	Min	Max	Unit
VBAT	Power supply voltage		3.63	V
VDDO	I/O supply voltage		3.63	V
VSSRF	RF front-end ground	-0.3		V
VSSA	Analog ground	-0.3		V
VSSD	Digital core and I/O ground	-0.3		V
V <sub>in</sub>	Voltage at any input pin	VSSD-0.3	VDDC + 0.3	V
T functional	Functional temperature range	-40	105	°C
T storage	Storage temperature range	-40	105	°C

Caution: Class 2 ESD Sensitivity, JESD22-A114-B (2000 V)  
The QFN package meets 450 V CDM level

Stresses exceeding those listed in the Maximum Ratings table may damage the device. If any of these limits are exceeded, device functionality should not be assumed, damage may occur and reliability may be affected.

Table 2. RECOMMENDED OPERATING CONDITIONS

Description	Symbol	Conditions	Min	Typ	Max	Units
Supply voltage operating range	VBAT	Input supply voltage on VBAT pin (Note 1)	1.18	1.25	3.3	V

Functional operation above the stresses listed in the Recommended Operating Ranges is not implied. Extended exposure to stresses beyond the Recommended Operating Ranges limits may affect device reliability.

1. In order to be able to use a VBAT Min of 1.1 V, the following reduced operating conditions should be observed:

- Maximum Tx power 0 dBm.
  - SYSClk ≤ 24 MHz.
  - Functional temperature range limited to 0–50 deg C
- The following trimming parameters should be used:

- VCC = 1.10 V
- VDDC = 0.92 V
- VDDM = 1.05 V, will be limited by VCC at end of battery life
- VDDRF = 1.05 V, will be limited by VCC at end of battery life. VDDPA should be disabled

RSL10 should enter in end-of-battery-life operating mode if VCC falls below 1.03 V. VCC will remain above 1.03 V if VBAT ≥ 1.10 V under the restricted operating conditions described above.

# NCV-RSL10

**Table 3. ELECTRICAL PERFORMANCE SPECIFICATIONS**

Unless otherwise noted, the specifications mentioned in the table below are valid at 25°C at VBAT = VDDO = 3 V.

Description	Symbol	Conditions	Min	Typ	Max	Units
<b>OVERALL</b>						
Current consumption RX, VBAT = 3 V	IVBAT		–	0.9	–	mA
Current consumption TX, VBAT = 3 V	IVBAT		–	0.9	–	mA
Deep sleep current, example 1, VBAT = 3 V	Ids1	Wake up form wake up pin.	–	25	–	nA
Deep sleep current, example 2, VBAT = 3 V	Ids2	Embedded 32 kHz oscillator running with interrupts from timer or external pin.	–	40	–	nA
Deep sleep current, example 3, VBAT = 3 V	Ids3	As Ids2 but with 8 kB RAM data retention.	–	100	–	nA
Standby Mode current, VBAT = 3 V	Istb	Digital blocks and memories are not clocked and are powered at a reduced voltage.	–	17	–	µA

**EEMBC ULPMark BENCHMARK, CORE PROFILE**

ULPMark CP 3.0 V		Arm Cortex–M3 processor running from RAM, VBAT= 3.0 V, IAR C/C++ Compiler for ARM 8.20.1.14183	–	1090	–	ULP Mark
ULPMark CP 2.1 V		Arm Cortex–M3 processor running from RAM, VBAT= 2.1 V, IAR C/C++ Compiler for ARM 8.20.1.14183	–	1260	–	ULP Mark

**EEMBC CoreMark BENCHMARK for the Arm Cortex–M3 Processor and the LPDSP32 DSP**

Arm Cortex–M3 processor running from RAM		At 48 MHz SYSCLK. Using the IAR 8.10.1 C compiler, certified		159		Core Mark
LPDSP32 running from RAM		At 48 MHz SYSCLK Using the 2017.03–SP3–2 release of the Synopsys LPDSP32 C compiler		133		Core Mark
Arm Cortex–M3 processor and LPDSP32 running from RAM, VBAT = 3 V		At 48 MHz SYSCLK		257		Core Mark/ mA

**INTERNALLY GENERATED VDDC: Digital Block Supply Voltage**

Supply voltage: operating range	VDDC		0.92	1.15	1.32 (Note 2)	V
Supply voltage: trimming range	VDDC <sub>RANGE</sub>		0.75		1.38	V
Supply voltage: trimming step	VDDC <sub>STEP</sub>		–	10	–	mV

**INTERNALLY GENERATED VDDM: Memories Supply Voltage**

Supply voltage: operating range	VDDM		1.05	1.15	1.32 (Note 3)	V
Supply voltage: trimming range	VDDM <sub>RANGE</sub>		0.75		1.38	V
Supply voltage: trimming step	VDDM <sub>STEP</sub>		–	10	–	mV

**INTERNALLY GENERATED VDDRF: Radio Front end supply voltage**

Supply voltage: operating range	VDDRF		1.00	1.10	1.32 (Notes 4 and 5)	V
Supply voltage: trimming range	VDDRF <sub>RANGE</sub>		0.75		1.38	V
Supply voltage: trimming step	VDDRF <sub>STEP</sub>		–	10	–	mV

**INTERNALLY GENERATED VDDPA: Optional Radio Power Amplifier Supply Voltage**

Supply voltage: operating range	VDDPA		1.05	1.3	1.68	V
Supply voltage: trimming range	VDDPA <sub>RANGE</sub>		1.05		1.68	V
Supply voltage: trimming step	VDDPA <sub>STEP</sub>		–	10	–	mV
Supply voltage: trimming step	DCDC <sub>STEP</sub>		–	10	–	mV

# NCV-RSL10

**Table 3. ELECTRICAL PERFORMANCE SPECIFICATIONS**

Unless otherwise noted, the specifications mentioned in the table below are valid at 25°C at VBAT = VDDO = 3 V.

Description	Symbol	Conditions	Min	Typ	Max	Units
<b>VDDO PAD SUPPLY VOLTAGE: Digital Level High Voltage</b>						
Digital I/O supply	VDDO		1.1		3.3	V
<b>INDUCTIVE BUCK DC-DC CONVERTER</b>						
VBAT range when the DC-DC converter is active (Note 6)	DCDC IN_RANGE		1.4		3.3	V
VBAT range when the LDO is active	LDO IN_RANGE		1.1		3.3	V
Output voltage: trimming range	DCDC OUT_RANGE		1.1	1.2	1.32	V
Supply voltage: trimming step	DCDC <sub>STEP</sub>		-	10	-	mV
<b>POWER-ON RESET</b>						
POR voltage	VBAT <sub>POR</sub>		0.4	0.8	1.0	V
<b>RADIO FRONT-END: General Specifications</b>						
RF input impedance	Z <sub>in</sub>	Single ended	-	50	-	Ω
Input reflection coefficient	S <sub>11</sub>	All channels	-	-	-8	dB
Data rate FSK / MSK / GFSK	R <sub>FSK</sub>	OQPSK as MSK	62.5	1000	3000	kbps
Data rate 4-FSK			-	-	4000	kbps
On-air data rate	bps	GFSK	250		2000	kbps
<b>RADIO FRONT-END: Crystal and Clock Specifications</b>						
Xtal frequency	F <sub>XTAL</sub>	Fundamental		48		MHz
Equiv. series Res.	ESR <sub>XTAL</sub>	RSL10 has internal load capacitors, additional external capacitors are not required	20	-	80	Ω
Differential equivalent load capacitance	CL <sub>XTAL</sub>	Internal load capacitors (NO EXTERNAL LOAD CAPACITORS REQUIRED)	6	8	10	pF
Settling time			-	0.5	1.5	ms
<b>RADIO FRONT-END: Synthesizer Specifications</b>						
Frequency range	F <sub>RF</sub>	Supported carrier frequencies	2360	-	2500	MHz
RX frequency step		RX Mode frequency synthesizer resolution	-	-	100	Hz
TX frequency step		TX Mode frequency synthesizer resolution	-	-	600	Hz
PLL Settling time, RX	t <sub>PLL_RX</sub>	RX Mode	-	15	25	μs
PLL Settling time, TX	t <sub>PLL_TX</sub>	TX mode, BLE modulation	-	5	10	μs
<b>RADIO FRONT-END: Receive Mode Specifications</b>						
Current consumption at 1 Mbps, V <sub>BAT</sub> = 3 V, DC-DC	IBAT <sub>RFRX</sub>	VDDRF = 1.1 V, 100% duty cycle	-	3.0	-	mA
Current consumption at 2 Mbps, V <sub>BAT</sub> = 3 V, DC-DC	IBAT <sub>RFRX</sub>	VDDRF = 1.1 V, 100% duty cycle	-	3.4	-	mA
RX Sensitivity, 0.25 Mbps		0.1% BER (Notes 7, 8)	-	-97	-	dBm
RX Sensitivity, 0.5 Mbps		0.1% BER (Notes 7, 8)	-	-96	-	dBm
RX Sensitivity, 1 Mbps, BLE		0.1% BER (Notes 7, 8) Single-ended on chip antenna match to 50 Ω	-	-94	-	dBm
RX Sensitivity, 2 Mbps, BLE		0.1% BER (Notes 7, 8)	-	-92	-	dBm
RSSI effective range		Without AGC	-	60	-	dB
RSSI step size			-	2.4	-	dB
RX AGC range			-	48	-	dB

# NCV-RSL10

**Table 3. ELECTRICAL PERFORMANCE SPECIFICATIONS**

Unless otherwise noted, the specifications mentioned in the table below are valid at 25°C at VBAT = VDDO = 3 V.

Description	Symbol	Conditions	Min	Typ	Max	Units
-------------	--------	------------	-----	-----	-----	-------

**RADIO FRONT-END: Receive Mode Specifications**

RX AGC step size		Programmable	–	6	–	dB
Max usable signal level		0.1% BER	0	5	–	dBm

**RADIO FRONT-END: Transmit Mode Specifications**

Tx peak power consumption at VBAT = 3 V (Note 9)	IBAT <sub>RFTX</sub>	Tx power 0 dBm, VDDRF = 1.07 V, VDDPA: off, DC-DC mode	–	4.6	–	mA
		Tx power 3 dBm, VDDRF = 1.1 V, VDDPA = 1.26 V, DC-DC mode	–	8.6	–	mA
		Tx power 6 dBm, VDDRF = 1.1 V, VDDPA = 1.60 V, DC-DC mode	–	12	–	mA
Transmit power range		BLE or 802.15.4 OQPSK	–17	+0.5	+6	dBm
Transmit power step size		Full band.	–	2	–	dB
Transmit power accuracy		Tx power 3 dBm. Full band. Relative to the typical value.	–1.5	–	+1	dB
		Tx power 0 dBm. Full band. Relative to the typical value.	–1.5	–	1.5	dB
Power in 2 <sup>nd</sup> harmonic		0 dBm mode. 50 Ω for “Typ” value. (Note 10)	–	–31	–18	dBm
Power in 3 <sup>rd</sup> harmonic		0 dBm mode. 50 Ω for “Typ” value. (Note 10)	–	–40	–31	dBm
Power in 4 <sup>th</sup> harmonic		0 dBm mode. 50 Ω for “Typ” value. (Note 10)	–	–49	–42	dBm

**ADC**

Resolution	ADC <sub>RES</sub>		8	12	14	bits
Input voltage range	ADC <sub>RANGE</sub>		0	–	2	V
INL	ADC <sub>INL</sub>		–2	–	+2	mV
DNL	ADC <sub>DNL</sub>		–1	–	+1	mV
Channel sampling frequency	ADC <sub>CH_SF</sub>	For the 8 channels sequentially, SLOWCLK = 1 MHz	0.0195	–	6.25	kHz

**32 kHz ON-CHIP RC OSCILLATOR**

Untrimmed Frequency	Freq <sub>UNTR</sub>		20	32	50	kHz
Trimming steps	Steps			1.5		%

**3 MHz ON-CHIP RC OSCILLATOR**

Untrimmed Frequency	Freq <sub>UNTR</sub>		2	3	5	MHz
Trimming steps	Steps			1.5		%
Hi Speed mode	Fhi			10		MHz

**32 kHz ON-CHIP CRYSTAL OSCILLATOR (Note 11)**

Output Frequency	Freq <sub>32k</sub>	Depends on xtal parameters		32768		Hz
Startup time				1	3	s
Internal load trimming range		Steps of 0.4 pF	0		25.2	pF
Load Capacitance		No external load capacitors required. Maximum external parasitic capacity allowed (package, routing, etc.)			3.5	pF
ESR					100	kΩ
Duty Cycle			40	50	60	%

**DC CHARACTERISTICS OF THE DIGITAL PADS – With VDDO = 2.97 V – 3.3 V, nominal: 3.0 V Logic**

Voltage level for high input	V <sub>IH</sub>		2		VDDO+0.3	V
------------------------------	-----------------	--	---	--	----------	---

# NCV-RSL10

**Table 3. ELECTRICAL PERFORMANCE SPECIFICATIONS**

Unless otherwise noted, the specifications mentioned in the table below are valid at 25°C at VBAT = VDDO = 3 V.

Description	Symbol	Conditions	Min	Typ	Max	Units
<b>DC CHARACTERISTICS OF THE DIGITAL PADS – With VDDO = 2.97 V – 3.3 V, nominal: 3.0 V Logic</b>						
Voltage level for low input	V <sub>IL</sub>		VSSD–0.3		0.8	V
<b>DIO DRIVE STRENGTH</b>						
DIO drive strength	IDIO		2	12	12	mA
<b>FLASH SPECIFICATIONS</b>						
Endurance of the 384 kB of flash			100,000			write/erase cycles
Endurance for sections NVR1, NVR2, and NVR3 (6 kB in total)			1000			write/erase cycles
Retention			25			years

Product parametric performance is indicated in the Electrical Characteristics for the listed test conditions, unless otherwise noted. Product performance may not be indicated by the Electrical Characteristics if operated under different conditions.

2. The maximum VDDC voltage cannot exceed the VBAT input voltage or the VCC output from the buck converter.
3. The maximum VDDM voltage cannot exceed the VBAT input voltage or the VCC output from the buck converter.
4. The maximum VDDRF voltage cannot exceed the VBAT input voltage or the VCC output from the buck converter.
5. The VDDRF calibrated targets are:
  - 1.10 V (TX power > 0 dBm, with optimal RX sensitivity)
  - 1.07 V (TX power = 0 dBm)
  - 1.20 V (TX power = 2 dBm)
 The VDDPA calibrated targets are:
  - 1.30 V
  - 1.26 V (TX power = 3 dBm, assumes VDDRF = 1.10 V)
  - 1.60 V (TX power = 6 dBm, assumes VDDRF = 1.10 V)
6. The LDO can be used to regulate down from VBAT and generate VCC. For VBAT values higher than 1.5 V, the LDO is less efficient and it is possible to save power by activating the DC-DC converter to generate VCC.
7. Signal generated by RF tester.
8. 0.5 to 1.0 dB degradation in the RX sensitivity is present on the QFN package. This is attributed to the presence of the metal slug of the QFN package which is in close proximity to on-chip inductors.
9. All values are based on evaluation board performance at the antenna connector, including the harmonic filter loss
10. The values shown here are without RF filter. Harmonics need to be filtered with an external filter (See “RF Filter” on Table 6).
11. These specifications have been validated with the Epson Toyocom MC – 306 crystal

**Table 4. VDDM Target Trimming Voltage as a Function of VDDO Voltage**

VDDM Voltage (V)	DIO_PAD_CFG DRIVE	Maximum VDDO Voltage (V)
1.05	1	2.7
1.05	0	3.2
1.10	0	3.3

NOTE: These are trimming targets at room/ATE temperature 25~30°C.

**Table 5. VDDO Target Trimming Voltage as a Function of SYSCLK Frequency**

VDDO Voltage (V)	Maximum SYSCLK Frequency (MHz)	Restriction
0.92	≤ 24	The ADC will be functional in low frequency mode and between 0 and 85°C only.
1.00	≤ 24	Fully functional
1.05	48	Fully functional

NOTE: These are trimming targets at room/ATE temperature 25~30°C.



# NCV-RSL10

**Table 6. RECOMMENDED EXTERNAL COMPONENTS:**

Components	Function	Recommended typical value	Tolerance
Cap (VBAT–VSSA)	VBAT decoupling	4.7 $\mu$ F + 100 pF (Note 12)	$\pm$ 20%
Cap (VDDO–VSSD)	VDDO decoupling	1 $\mu$ F	$\pm$ 20%
Cap (VDDRF–VSSRF)	VDDRF decoupling	2.2 $\mu$ F	$\pm$ 20%
Cap (VCC–VSSA)	VCC decoupling	Low ESR 2.2 $\mu$ F (Note 13) or 4.7 $\mu$ F	$\pm$ 20%
Cap (VDDA–VSSA)	VDDA decoupling	1 $\mu$ F	$\pm$ 20%
Cap (CAP0–CAP1)	Pump capacitor for the charge pump	1 $\mu$ F	$\pm$ 20%
Inductor (DC–DC)	DC–DC converter inductance	Low ESR 2.2 $\mu$ H (See Table 7 below)	$\pm$ 20%
Xtal_32 kHz	Xtal for 32 kHz oscillator	– MC – 306, Epson – CM8V–T1A, Micro Crystal Switzerland	
Xtal_48 MHz	Xtal for 48 MHz oscillator	8Q–48.000MEEV–T, TXC Corporation, Taiwan	
RF filter (Note 14)	External harmonic filter	1.5 pF / 3 nH / 1.5 pF / 1.8 nH	$\pm$ 20%

NOTE: All capacitors used must have good RF performance.

12. The recommended decoupling capacitance uses 2 capacitors with the values specified.

13. Example: AMK105BJ225\_P, Taiyo Yuden.

14. For improved harmonic performance in environments where RSL10 is operating in close proximity to smartphones or base stations, FBAR filters such as the Broadcom ACPFP–7924 can be applied instead of the suggested discrete harmonic filter.

**Table 7. RECOMMENDED DC–DC CONVERTER INDUCTANCE TABLE**

Manufacturer	Part Number	Case Size	Comments
Taiyo Yuden	CKP2012N_2R2	0805 SMD with $T_{max} = 1.0$ mm	A degradation of 1 dB in the RX sensitivity is expected in DC–DC mode (Vbat = 3.3 V) versus LDO mode operation.
Taiyo Yuden	CBMF1608T2R2M	0603 SMD with $T_{max} = 1.0$ mm	A degradation of <1 dB in RX sensitivity is expected in DC–DC mode (Vbat = 3.3 V) versus LDO mode operation. Also, the current drawn from the battery will be 4–10% higher than when the CKP2012N_2R2 is used depending on operation mode and settings.

NOTE: Values have been measured on the QFN version of the RSL10 development board.

## PCB Design Guidelines

1. Decoupling capacitors should be placed as close to the related pins as possible.
2. Differential output signals should be routed as symmetrically as possible.
3. Analog input signals should be shielded as well as possible.
4. Pay close attention to the parasitic coupling capacitors.
5. Special care should be made for PCB design in order to obtain good RF performance.
6. Multi–layer PCB should be used with a keep–out area on the inner layers directly below the antenna matching circuitry in order to reduce the stray capacitances that influence RF performance.
7. All the supply voltages should be decoupled as close as possible to their respective pin with high performance RF capacitors. These supplies should be routed separately from each other and if possible on different layers with short lines on the PCB from the chip’s pin to the supply source.
8. Digital signals shouldn’t be routed close to the crystal or the power supply lines.
9. Proper DC–DC component placement and layout is critical to RX sensitivity performance in DC–DC mode.



# NCV-RSL10

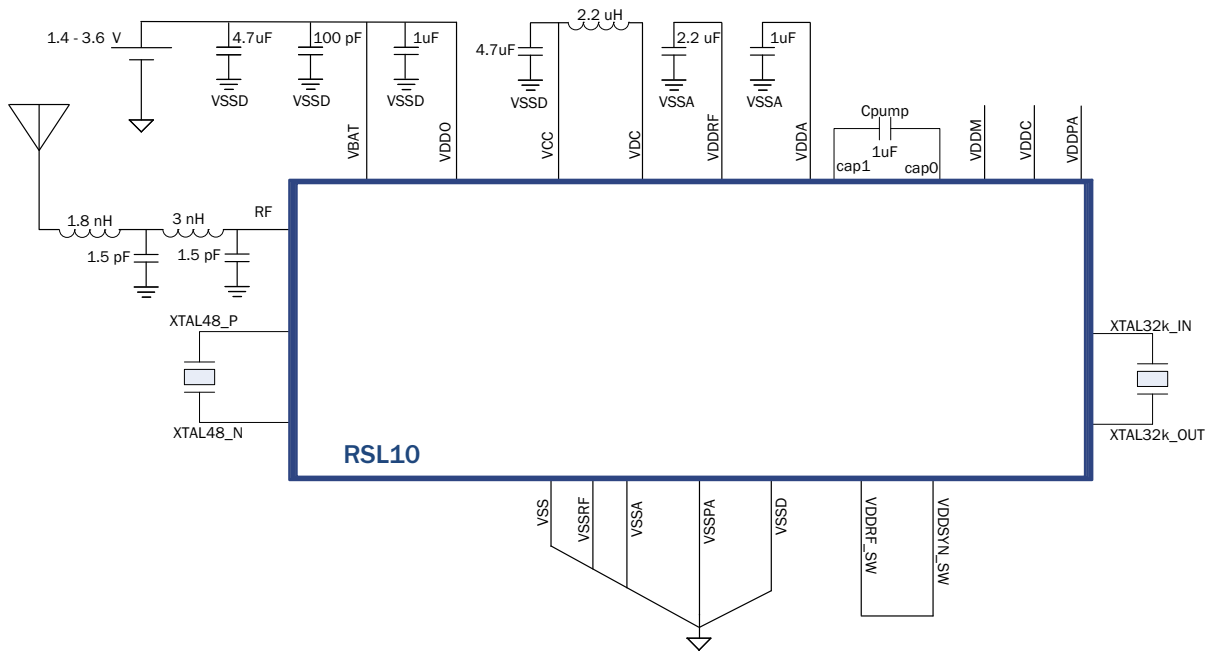

**Figure 2. RSL10 Application Diagram in Buck Mode**

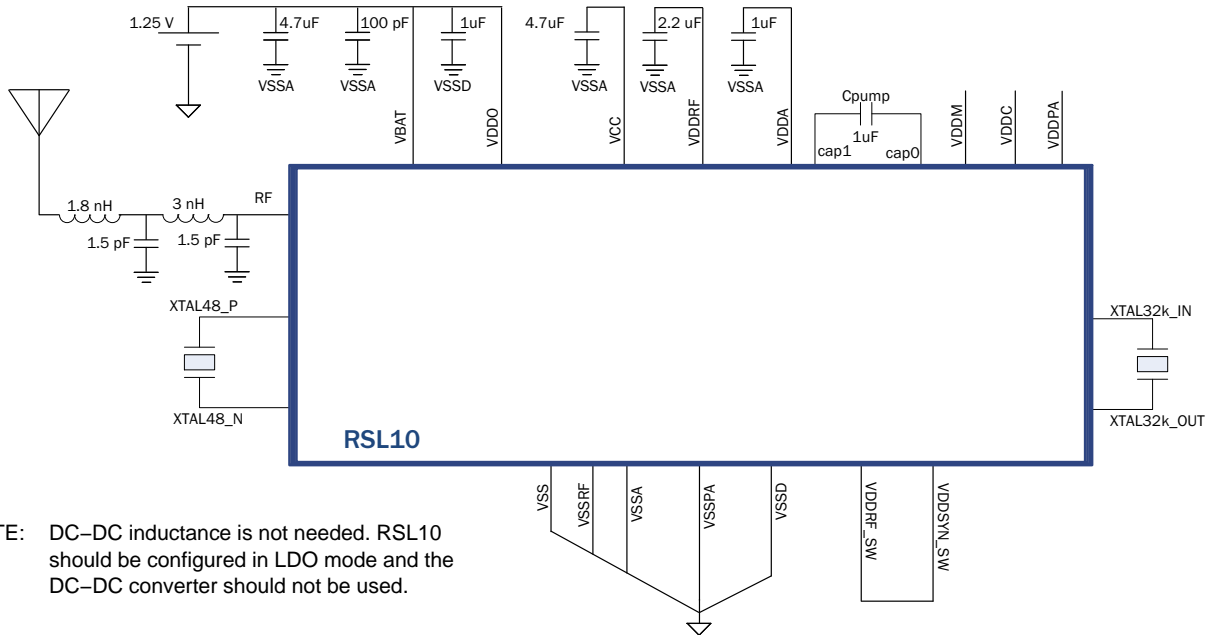

NOTE: DC-DC inductance is not needed. RSL10 should be configured in LDO mode and the DC-DC converter should not be used.

**Figure 3. RSL10 Application Diagram in LDO Mode**

**Table 8. CHIP INTERFACE SPECIFICATIONS**

Pad Name	Description	Power Domain	I/O	A/D	Pull	Pad #, QFN48
VBAT	Battery input voltage	VBAT	I	P		9
VDC	DC-DC output voltage to external LC filter		O	A		10
VCC	DC-DC filtered output		I	P/A		12
XTAL32_IN	Xtal input pin for 32 kHz xtal		I/O	A		14
XTAL32_OUT	Xtal output pin for 32 kHz xtal		I/O	A		13
VSSA	Analog ground		I/O	P		8
RES	RESERVED		I	D	D	11
VDDA	Charge pump output for analog and flash supplies	VDDA	I/O	P/A		5
VDDRF	LDO's output for radio voltage supply		I/O	P/A		48
CAP0	Pump capacitor connection		O	A		7
CAP1	Pump capacitor connection		O	A		6
AOUT	Analog test pin		O	A		4
VDDRF_SW	Supply pin for the RF	VDDRF_SW		P/A		47
VDDSYN_SW	Supply pin for the radio synthesizer			P/A		45
VSSRF	RF analog ground		I/O	P		46
XTAL48_N	Negative input for the 48 MHz xtal block		I/O	A		43
XTAL48_P	Positive input for the 48 MHz xtal block		I/O	A		44
VDDPA	Radio power amplifier voltage supply	VDDPA	I/O	P/A		2
VSSPA	Radio power amplifier ground		I/O	P		3
RF	RF signal input/output (Antenna)	RF	I/O	A		1
VPP	Flash high voltage access	VPP	I/O	A		17

**Table 8. CHIP INTERFACE SPECIFICATIONS**

Pad Name	Description	Power Domain	I/O	A/D	Pull	Pad #, QFN48
NRESET	Reset pin	VDDO	I	D	U1	16
WAKEUP	Wake-up pin for power modes		I	A		15
VDDC	LDO output for Core logic voltage supply		I/O	P		19
VDDM	LDO output for memories voltage supply		I/O	P		21
VDDO	Digital I/O voltage supply		I	P		36
VSSD	Digital ground pad for I/O		I/O	P		28, 35
VSS (*)	Substrate connection for the RF part		I/O	P		42
EXTCLK	External clock input		I	D	U	31
DIO[0]	Digital input output / ADC 0		I/O	A/D	U/D	18
DIO[1]	Digital input output / ADC 1		I/O	A/D	U/D	20
DIO[2]	Digital input output / ADC 2		I/O	A/D	U/D	23
DIO[3]	Digital input output / ADC 3		I/O	A/D	U/D	25
DIO[4]	Digital input output 4		I/O	D	U/D	24
DIO[5]	Digital input output 5		I/O	D	U/D	27
DIO[6]	Digital input output 6		I/O	D	U/D	29
DIO[7]	Digital input output 7		I/O	D	U/D	30
DIO[8]	Digital input output 8		I/O	D	U/D	26
DIO[9]	Digital input output 9		I/O	D	U/D	22
DIO[10]	Digital input output 10		I/O	D	U/D	32
DIO[11]	Digital input output 11		I/O	D	U/D	38
DIO[12]	Digital input output 12		I/O	D	U/D	37
DIO[13]	Digital input output / CM3-JTAG Test Reset		I/O	D	U/D	39
DIO[14]	Digital input output / CM3-JTAG Test Data In		I/O	D	U/D	41
DIO[15]	Digital input output / CM3-JTAG Test Data Out		I/O	D	U/D	40
JTCK	CM3-JTAG Test Clock		I/O	D	U	33
JTMS	CM3-JTAG Test Mode State		I/O	D	U	34

\*VSS should be connected to VSSRF at the PCB level.

NOTE: It is recommended that the QFN package metal slug be left open/floating for optimal Rx sensitivity performance

**Legend:**

Type: A = analog; D = digital; I = input; O = output; P = power

Pull: U = pull up; D = pull down

Pull up: selectable between 10 kΩ and 250 kΩ

Pull down: 250 kΩ

All digital pads have a Schmitt trigger input.

All DIO pads have a programmable I<sup>2</sup>C low pass filter.

# NCV-RSL10

## ARCHITECTURE OVERVIEW

The architecture of the RSL10 chip is shown in Figure 4.

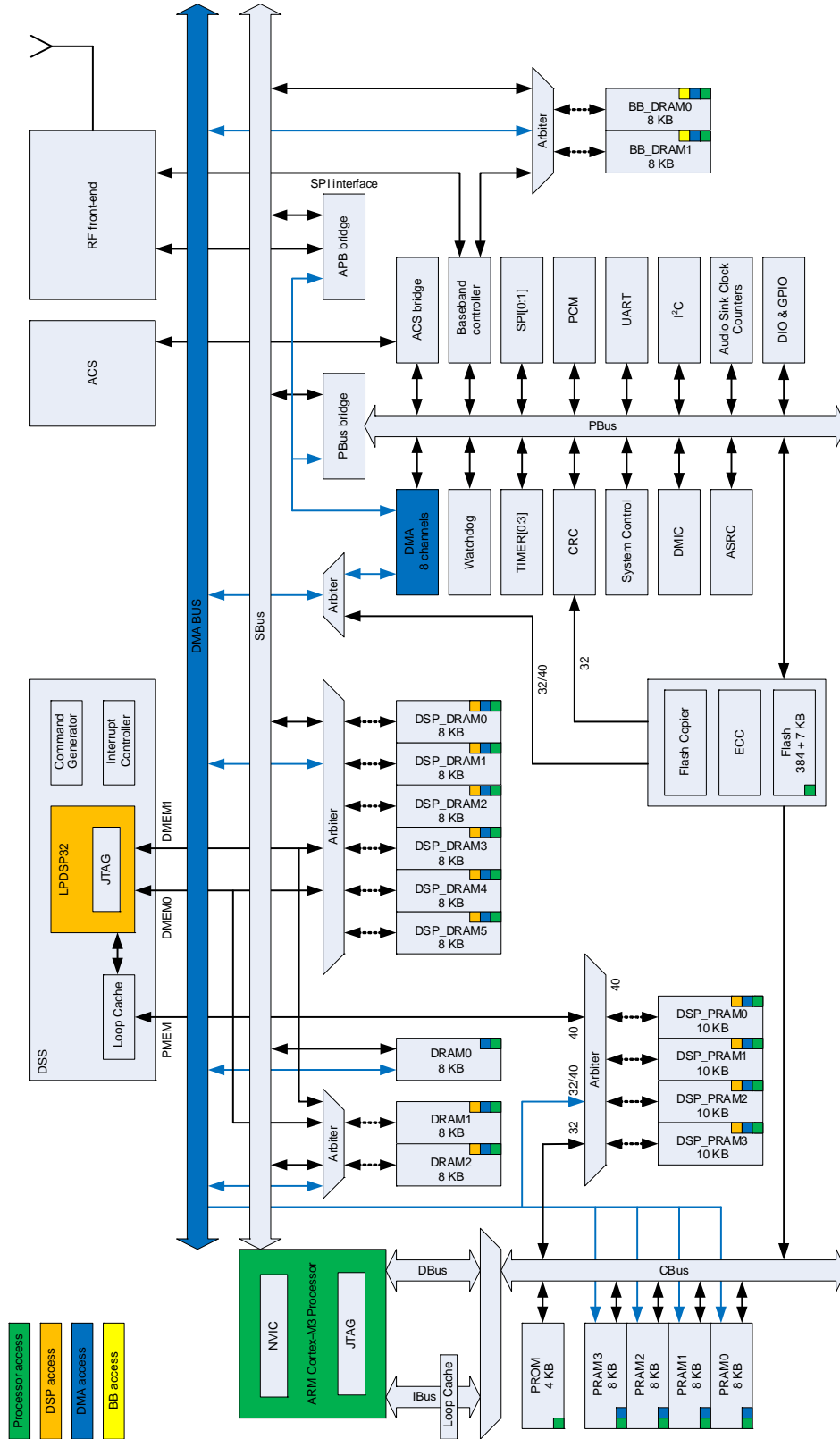

Figure 4. RSL10 Architecture

## Power Management Unit

The RSL10 power management unit prevents system brown-outs in case the battery voltage dips below the specified minimum voltage required for reliable operation. It does this by:

1. Monitoring the power supply and safely shutting down the system if needed.
2. Preventing possible damage to RSL10 when the battery is inserted or removed.
3. Allowing operation across wide temperature and voltage ranges at low power consumption.

RSL10 allows the use of either the DC-DC converter for a better efficiency when the battery voltage is higher than 1.4 V or the internal LDO when VBAT is lower than 1.4 V. The output of the DC-DC converter or the LDO regulator is used to supply other voltage regulator blocks of RSL10. These blocks are:

- A programmable voltage regulator to supply the digital cores (VDDC)
- A programmable voltage regulator to supply the memories (VDDM)
- A charge pump supplying the analog blocks and the flash memory (VDDA)
- A programmable voltage regulator to supply the radio front-end (VDDRF)
- A programmable voltage regulator to supply the power amplifier of the radio (VDDPA): This regulator is used only for the +6 dBm output power case or if we want to transmit at +3 dBm output power with a battery level less than 1.4 V. The VDDPA regulator can be disabled if RSL10 doesn't have to transmit at high power, and VDDRF only should be used.

## Clock and Clocking Options

RSL10's system clock (SYSCLK) can come from various sources:

- A 48 MHz crystal oscillator, used in normal operation mode
- An internal trimmable RC oscillator that supplies a 3 MHz – 12 MHz clock used at system startup
- A Real Time Clock, used in stand-by mode, generated from one of:
  - ◆ A 32 kHz RC oscillator
  - ◆ A 32 kHz crystal oscillator
  - ◆ An external input on one of DIO0 to DIO3
- A JTAG clock, used in debug mode, coming from the JTCK pad
- An external clock source, coming from the EXTCLK pad

Every clock generated in the system can be disabled when they are not needed. Also, every clock has an associated

configurable prescaler to minimize the power dissipated on the clock tree.

A clock detector unit can be used to monitor the system clock and/or the RTC clock in sleep and standby modes. In the event the clock frequency goes below a certain threshold, the RSL10 IC will be reset. The clock detector threshold is nominally 2 kHz. This block and the reset it triggers is enabled by default, but both can be disabled.

## Radio Front-End

RSL10 2.4 GHz radio front-end implements the physical layer for the Bluetooth low energy technology standard and other standard, proprietary, and custom protocols. It operates in the worldwide deployable 2.4 GHz ISM band (2.4000 to 2.4835 GHz) and supports:

- Bluetooth 5 certified with LE 2M PHY support

The RSL10 Radio Front End includes the necessary hardware to support the following protocols:

- The IEEE 802.15.4 standard, used as the physical layer for many standard and proprietary protocols including ZigBee and Thread
- Proprietary protocols

The 2.4 GHz radio front-end is based on a low-IF architecture and comprises the following building blocks:

- High performance single-ended RF port
- On-chip matching network with 50 ohm RF input
- High gain, low power LNA (low noise amplifier), and mixer
- PA (Power Amplifier) with +3 dBm output power for Bluetooth and 802.15.4 OQPSK applications, and up to +6 dBm with dedicated PA voltage supply
- ADC converter
- RSSI (Received Signal Strength Indication) with 60 dB nominal range with 2.4 dB steps (not considering AGC)
- Fully integrated ultra-low power frequency synthesis with fast settling time, with direct digital modulation in transmission (pulse shape programmable)
- 48 MHz XTAL reference (finely trimmable)
- Fully-integrated FSK-based modem with programmable pulse shape, data rate, and modulation index
- Digital baseband (DBB) with Link layer functionalities, including automatic packet handling with preamble & sync, CRC, and separate Rx and Tx 128-bytes FIFOs
- Serial and parallel digital interfaces

The 2.4 GHz radio front-end contains a full transceiver with the following features:

- IEEE 802.15.4 chip encoding & decoding
- Manchester encoding
- Data whitening

The 2.4 GHz radio front-end contains also a highly-flexible digital baseband—in terms of modulations, configurability and programmability – in order to support Bluetooth low energy technology, 802.15.4 OQPSK and DSSS, and proprietary protocols. It allows for programmable data rates from 62.5 kbps up to 2 Mbps, FSK with programmable pulse shape and modulation index.

The 2.4 GHz radio front-end also include IEEE 802.15.4 chip encoding & decoding, Manchester encoding and Data whitening. Its packet handling includes:

- Automatic preamble and sync word insertion
- Automatic packet length handler
- Basic address check
- Automatic CRC calculation and verification with a programmable CRC polynomial
- Multi-frame support
- 2x128 byte FIFOs

**Baseband Controller and Software Stack**

The RSL10 Bluetooth baseband controller is connected to the radio front-end. It configures the physical layer of the RSL10 for use as a Bluetooth low energy technology device. It provides access and support for the Direct-Test Mode (DTM) layer for RF testing, and it implements portions of the link layer and other controller level components from the Bluetooth stack. It is dedicated to low level bitwise operations and data packet processing.

RSL10 is Bluetooth 5 certified and includes LE 2 Mbps support and all optional features from earlier versions of Bluetooth low energy technology.

Also, the coexistence between Bluetooth and a custom protocol is supported.

The software stack, including the profiles and the application, handles the protocol functions and is executed on the Arm Cortex-M3 processor. The Bluetooth IP implementation is split among software and hardware as shown in Figure 5.

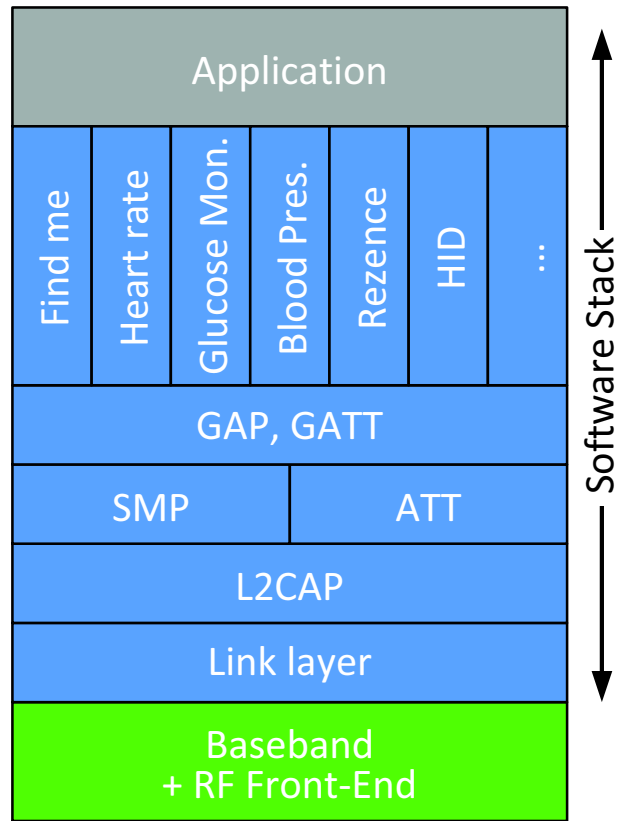

**Figure 5. Bluetooth Protocol Implementation**

The following is a sample of the Bluetooth low energy profiles supported by RSL10. For more information and a complete list of the profiles offered, please download the RSL10 SDK.

- Find Me
- Proximity
- HID over GATT (HOG)
- Alert Notification
- Phone Alert Status
- Location and Navigation
- Rezence (custom protocol defined by AirFuel™ Alliance to support wireless battery charging)

## Arm Cortex-M3 Processor Subsystem

The Arm Cortex-M3 processor subsystem includes the Arm Cortex-M3 processor, which is the master processor of the RSL10 chip. It also contains the Bluetooth baseband controller, and all interfaces and other peripherals.

## Arm Cortex-M3 Processor

The Arm Cortex-M3 processor is a state-of-the-art 32-bit core with embedded multiplier and ALU for handling typical control functions. Software development is done in C.

It features a low gate count, low interrupt latency, and low-cost debug functionality. It is primarily intended for deeply embedded applications that require low power consumption with fast interrupt response. The processor implements the Arm architecture v7-M. For power management, the processor can be placed under firmware control, into a Standby mode, in which the processor clock is disabled. The Nested Vectored Interrupt Controller (NVIC) will continue to run to enable exiting Standby mode on an interrupt.

## LPDSP32

LPDSP32 is a C-programmable, 32-bit DSP developed by ON Semiconductor. LPDSP32 is a high efficiency, dual Harvard DSP that supports both single (32-bit) and double precision (64-bit) arithmetic.

LPDSP32's dual MAC unit, load store architecture is specifically optimized to support audio processing tasks. The advanced architecture also provides:

- Two 72-bit ALUs capable of doing single and double precision arithmetic and logical operations
- Two 32-bit integer/fractional multipliers
- Four 64-bit accumulators with 8-bit overflow (extension bits)

Communications to the Arm Cortex-M3 processor are completed via interrupts and shared memories. Software development is done in C, and the development tools are provided upon request from Synopsys.

## Interfaces

RSL10 includes:

- Two independent SPI interfaces that can be configured in master and slave mode
- A fully configurable PCM interface
- A standard general purpose I<sup>2</sup>C interface
- A standard general purpose UART interface

- Two PWM (Pulse Width Modulation) drivers that can generate a single bit output signal at a given frequency
- SWJ-DP interface for the Arm Cortex-M3 processor
- JTAG interface for LPDSP32

RSL10 includes 16 DIO pads (Digital Input/Output) that all can be assigned to any of the interfaces above, or used as general purpose DIOs.

## Peripherals

RSL10 includes:

- Four general purpose timers
- A DMA (Direct Memory Access) controller to transfer data between peripherals and memories without any core intervention
- A flash copier to initialize SRAM memories and that can be used with the CRC blocks to validate flash memory contents
- An Analog to Digital converter (ADC), accessed by the Arm Cortex-M3 processor. The ADC can read 4 external values (DIO[0]-DIO[3]), AOUT, VDDC, VBAT/2 and the ADC offset value.
- Two standard Cyclic Redundancy Code (CRC) blocks to ensure data integrity of the user application code and data
- A Watchdog timer to detect and recover from RSL10 malfunctions.
- Four autonomous 32-bit Activity Counters. These counters help analyze how long the system has been running and how much the Arm Cortex-M3 processor, LPDSP32, and the flash memory have been used by the application. This is useful information to estimate and optimize the power consumption of the application.
- An IP protection system to ensure that the flash content cannot be copied by a third party. It can be used to prevent any core or memory of the RSL10 from being accessed externally after the RSL10 has booted.
- Program memory loop caches for each processor to reduce the RSL10 power consumption. This reduces the number of flash and RAM memory accesses by caching the program words that are read in these loops.

## RSL10 Memory Structure

Table 9 lists the memory structures attached to RSL10, and the size and width of each memory structure.



**Table 9. RSL10 MEMORY STRUCTURES**

Memory type	Data Width	Memory Size	Accessed by
Program memory (ROM)	32	4 kB	Arm Cortex-M3 processor
Program memory (RAM)	32	4 instances of 8 kB	Arm Cortex-M3 processor
Program memory (RAM)	40	4 instances of 10 kB	LPDSP32 / Arm Cortex-M3 processor
Data memory (RAM)	32	1 instances of 8 kB	Arm Cortex-M3 processor
Data memory (RAM)	32	2 instances of 8 kB	Arm Cortex-M3 processor / LPDSP32
Data memory (RAM)	32	6 instances of 8 kB	LPDSP32 / Arm Cortex-M3 processor
Data memory (RAM)	32	2 instances of 8 kB	Baseband / Arm Cortex-M3 processor
Flash	32	384 kB	Arm Cortex-M3 processor / Flash copier

**Chip Identification**

System identification is used to identify different system components. For the RSL10 chip, the key identifier components and values are as follows:

- Chip Family: 0x09
- Chip Version: 0x01
- Chip Revision: 0x01

**Electrostatic Discharge (ESD) Sensitive Device**

**CAUTION:** ESD sensitive device. Permanent damage may occur on devices subjected to high-energy electrostatic discharges. Proper ESD precautions in handling, packaging and testing are recommended to avoid performance degradation or loss of functionality.

**Solder Information**

The RSL10 QFN package is constructed with all RoHS compliant material and should be reflowed accordingly.

This device is Moisture Sensitive Class MSL3 and must be stored and handled accordingly. Re-flow according to

IPC/JEDEC standard J-STD-020C, Joint Industry Standard: Re-flow Sensitivity Classification for Nonhermetic Solid State Surface Mount Devices. Hand soldering is not recommended for this part.

**Development Tools**

RSL10 is supported by a full suite of comprehensive tools including:

- An easy-to-use development board
- Software Development Kit (SDK) including an Oxygen Eclipse-based development environment, Bluetooth protocol stacks, sample code, libraries, and documentation

**Company or Product Inquiries**

For more information about ON Semiconductor products or services visit our Web site at <http://onsemi.com>.

For sales or technical support, contact your local representative or authorized distributor.

# NCV-RSL10

## PACKAGE DIMENSIONS

WQFNW48 7x7, 0.5P  
CASE 512AD  
ISSUE O

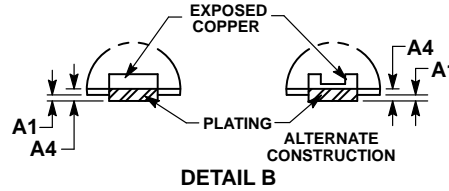
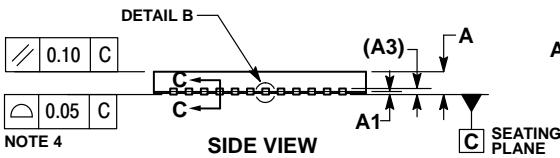
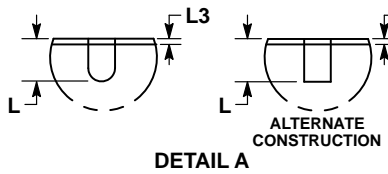
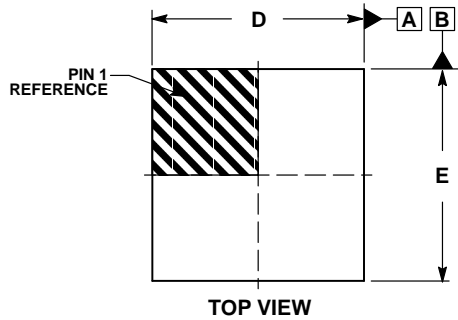

- NOTES:
1. DIMENSIONS AND TOLERANCING PER ASME Y14.5M, 1994.
  2. CONTROLLING DIMENSION: MILLIMETERS.
  3. DIMENSION b APPLIES TO THE PLATED TERMINAL AND IS MEASURED ABETWEEN 0.15 AND 0.30 MM FROM THE TERMINAL TIP.
  4. COPLANARITY APPLIES TO THE EXPOSED PAD AS WELL AS THE TERMINALS.

DIM	MILLIMETERS		
	MIN	NOM	MAX
A	0.70	0.75	0.80
A1	---	---	0.05
A3	0.20 REF		
A4	0.10 REF		
b	0.20	0.25	0.30
D	6.90	7.00	7.10
D2	3.00	3.10	3.20
E	6.90	7.00	7.10
E2	3.00	3.10	3.20
e	0.50 BSC		
K	1.55 REF		
L	0.30	0.40	0.50
L3	0.05 REF		

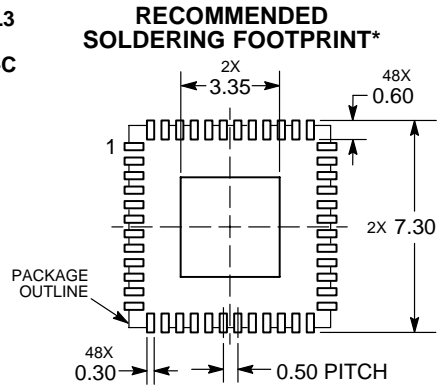
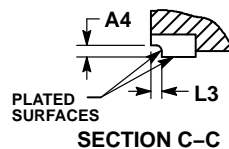
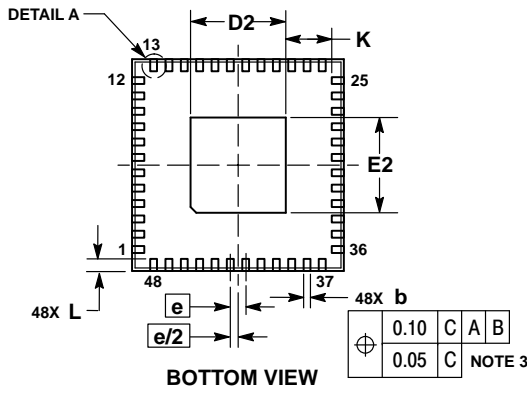

DIMENSIONS: MILLIMETERS

\*For additional information on our Pb-Free strategy and soldering details, please download the ON Semiconductor Soldering and Mounting Techniques Reference Manual, SOLDERRM/D.

ON Semiconductor is licensed by the Philips Corporation to carry the I<sup>2</sup>C bus protocol.  
AirFuel is a trademark of Air Routing International Corporation.  
Bluetooth is a registered trademark of Bluetooth SIG.  
Arm and Cortex are registered trademarks of Arm Limited (or its subsidiaries).

ON Semiconductor and are trademarks of Semiconductor Components Industries, LLC dba ON Semiconductor or its subsidiaries in the United States and/or other countries. ON Semiconductor owns the rights to a number of patents, trademarks, copyrights, trade secrets, and other intellectual property. A listing of ON Semiconductor's product/patent coverage may be accessed at [www.onsemi.com/site/pdf/Patent-Marking.pdf](http://www.onsemi.com/site/pdf/Patent-Marking.pdf). ON Semiconductor reserves the right to make changes without further notice to any products herein. ON Semiconductor makes no warranty, representation or guarantee regarding the suitability of its products for any particular purpose, nor does ON Semiconductor assume any liability arising out of the application or use of any product or circuit, and specifically disclaims any and all liability, including without limitation special, consequential or incidental damages. Buyer is responsible for its products and applications using ON Semiconductor products, including compliance with all laws, regulations and safety requirements or standards, regardless of any support or applications information provided by ON Semiconductor. "Typical" parameters which may be provided in ON Semiconductor data sheets and/or specifications can and do vary in different applications and actual performance may vary over time. All operating parameters, including "Typicals" must be validated for each customer application by customer's technical experts. ON Semiconductor does not convey any license under its patent rights nor the rights of others. ON Semiconductor products are not designed, intended, or authorized for use as a critical component in life support systems or any FDA Class 3 medical devices or medical devices with a same or similar classification in a foreign jurisdiction or any devices intended for implantation in the human body. Should Buyer purchase or use ON Semiconductor products for any such unintended or unauthorized application, Buyer shall indemnify and hold ON Semiconductor and its officers, employees, subsidiaries, affiliates, and distributors harmless against all claims, costs, damages, and expenses, and reasonable attorney fees arising out of, directly or indirectly, any claim of personal injury or death associated with such unintended or unauthorized use, even if such claim alleges that ON Semiconductor was negligent regarding the design or manufacture of the part. ON Semiconductor is an Equal Opportunity/Affirmative Action Employer. This literature is subject to all applicable copyright laws and is not for resale in any manner.

### PUBLICATION ORDERING INFORMATION

**LITERATURE FULFILLMENT:**  
Literature Distribution Center for ON Semiconductor  
19521 E. 32nd Pkwy, Aurora, Colorado 80011 USA  
Phone: 303-675-2175 or 800-344-3860 Toll Free USA/Canada  
Fax: 303-675-2176 or 800-344-3867 Toll Free USA/Canada  
Email: [orderlit@onsemi.com](mailto:orderlit@onsemi.com)

**N. American Technical Support:** 800-282-9855 Toll Free  
USA/Canada  
**Europe, Middle East and Africa Technical Support:**  
Phone: 421 33 790 2910

**ON Semiconductor Website:** [www.onsemi.com](http://www.onsemi.com)  
**Order Literature:** <http://www.onsemi.com/orderlit>

For additional information, please contact your local Sales Representative