

NC7SP74 TinyLogic® ULP D-Type Flip-Flop with Preset and Clear

General Description

The NC7SP74 is a single D-type CMOS Flip-Flop with preset and clear from Fairchild's Ultra Low Power (ULP) Series of TinyLogic®. Ideal for applications where battery life is critical, this product is designed for ultra low power consumption within the V_{CC} operating range of 0.9V to 3.6V.

The internal circuit is composed of a minimum of inverter stages including the output buffer, to enable ultra low static and dynamic power.

The NC7SP74, for lower drive requirements, is uniquely designed for optimized power and speed, and is fabricated with an advanced CMOS technology to achieve best in class speed operation while maintaining extremely low CMOS power dissipation.

The signal level applied to the D input is transferred to the Q output during the positive going transition of the CLK pulse.

Features

- Space saving US8 surface mount package
- MicroPak™ Pb-Free leadless package
- 0.9V to 3.6V V_{CC} supply operation
- 3.6V overvoltage tolerant I/Os at V_{CC} from 0.9V to 3.6V
- t_{PD}
 - 3.0 ns typ for 3.0V to 3.6V V_{CC}
 - 4.0 ns typ for 2.3V to 2.7V V_{CC}
 - 5.0 ns typ for 1.65V to 1.95V V_{CC}
 - 6.0 ns typ for 1.40V to 1.60V V_{CC}
 - 9.0 ns typ for 1.10V to 1.30V V_{CC}
 - 24.0 ns typ for 0.90V V_{CC}
- Power-Off high impedance inputs and outputs
- Static Drive (I_{OH}/I_{OL})
 - ±2.6 mA @ 3.00V V_{CC}
 - ±2.1 mA @ 2.30V V_{CC}
 - ±1.5 mA @ 1.65V V_{CC}
 - ±1.0 mA @ 1.40V V_{CC}
 - ±0.5 mA @ 1.10V V_{CC}
 - ±20 μ A @ 0.9V V_{CC}
- Uses patented Quiet Series™ noise/EMI reduction circuitry
- Ultra low dynamic power

Ordering Code:

| Order Number | Package Number | Product Code Top Mark | Package Description | Supplied As |
|--------------|----------------|-----------------------|---|---------------------------|
| NC7SP74K8X | MAB08A | P74 | 8-Lead US8, JEDEC MO-187, Variation CA 3.1mm Wide | 3k Units on Tape and Reel |
| NC7SP74L8X | MAC08A | X9 | Pb-Free 8-Lead MicroPak, 1.6 mm Wide | 5k Units on Tape and Reel |

Pb-Free package per JEDEC J-STD-020B.

Battery Life vs. V_{CC} Supply Voltage

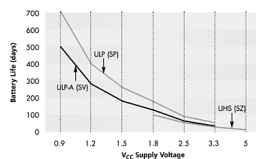

TinyLogic ULP and ULP-A with up to 50% less power consumption can extend your battery life significantly.

$$\text{Battery Life} = (V_{\text{battery}} \cdot I_{\text{battery}} \cdot 9) / (P_{\text{device}}) / 24 \text{hrs/day}$$

$$\text{Where, } P_{\text{device}} = (I_{CC} \cdot V_{CC}) + (C_{PD} + C_L) \cdot V_{CC}^2 \cdot f$$

Assumes ideal 3.6V Lithium Ion battery with current rating of 900mAh and derated 90% and device frequency at 10MHz, with $C_L = 15$ pF load

TinyLogic® is a registered trademark of Fairchild Semiconductor Corporation.

MicroPak™ and Quiet Series™ are trademarks of Fairchild Semiconductor Corporation.

Pin Descriptions

| Pin Names | Description |
|--------------------------|---------------------|
| D | Data Input |
| CK | Clock Pulse Input |
| $\overline{\text{CLR}}$ | Direct Clear Input |
| Q, $\overline{\text{Q}}$ | Flip-Flop Output |
| $\overline{\text{PR}}$ | Direct Preset Input |

Logic Symbol

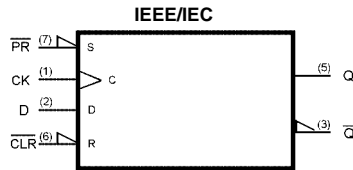

Truth Table

| Inputs | | | | Outputs | | Function |
|-------------------------|------------------------|---|----|---------|-----------------------|-----------|
| $\overline{\text{CLR}}$ | $\overline{\text{PR}}$ | D | CK | Q | $\overline{\text{Q}}$ | |
| L | H | X | X | L | H | Clear |
| H | L | X | X | H | L | Preset |
| L | L | X | X | H | H | — |
| H | H | L | ↑ | L | H | — |
| H | H | H | ↑ | H | L | — |
| H | H | X | ↓ | Q_n | \overline{Q}_n | No Change |

H = HIGH Logic Level
 L = LOW Logic Level
 Q_n = No change in data
 X = Immaterial
 Z = High Impedance
 ↑ = Rising Edge
 ↓ = Falling edge

Connection Diagrams

Pin Assignments for US8

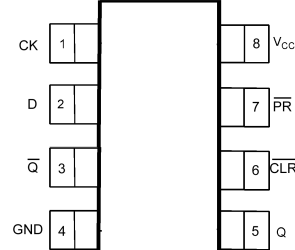

(Top View)

Pin One Orientation Diagram

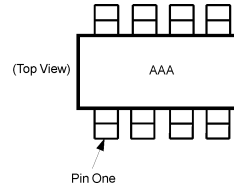

AAA represents Product Code Top Mark - see ordering code

Note: Orientation of Top Mark determines Pin One location. Read the top product code mark left to right, Pin One is the lower left pin (see diagram).

Pad Assignments for MicroPak

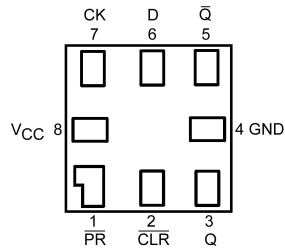

(Top Thru View)

| Absolute Maximum Ratings (Note 1) | | Recommended Operating Conditions (Note 3) | |
|---|--------------------------|---|-------------------|
| Supply Voltage (V_{CC}) | -0.5V to +4.6V | Power Supply | 0.9V to 3.6V |
| DC Input Voltage (V_{IN}) | -0.5V to +4.6V | Input Voltage (V_{IN}) | 0V to 3.6V |
| DC Output Voltage (V_{OUT}) | -0.5V to +7.0V | Output Voltage (V_{OUT}) | HIGH or LOW State |
| HIGH or LOW State (Note 2) | -0.5V to $V_{CC} + 0.5V$ | HIGH or LOW State | 0V to V_{CC} |
| $V_{CC} = 0V$ | -0.5V to 4.6V | $V_{CC} = 0V$ | 0V to 3.6V |
| DC Input Diode Current (I_{IK}) $V_{IN} < 0V$ | ± 50 mA | Output Current in (I_{OH}/I_{OL}) | |
| DC Output Diode Current (I_{OK}) | | $V_{CC} = 3.0V$ to 3.6V | ± 2.6 mA |
| $V_{OUT} < 0V$ | -50 mA | $V_{CC} = 2.3V$ to 2.7V | ± 2.1 mA |
| $V_{OUT} > V_{CC}$ | +50 mA | $V_{CC} = 1.65V$ to 1.95V | ± 1.5 mA |
| DC Output Source/Sink Current (I_{OH}/I_{OL}) | ± 50 mA | $V_{CC} = 1.40V$ to 1.60V | ± 1.0 mA |
| DC V_{CC} or Ground Current per | | $V_{CC} = 1.10V$ to 1.30V | ± 0.5 mA |
| Supply Pin (I_{CC} or Ground) | ± 50 mA | $V_{CC} = 0.9V$ | ± 20 μA |
| Storage Temperature Range (T_{STG}) | -65°C to +150°C | Free Air Operating Temperature (T_A) | -40°C to +85°C |
| | | Minimum Input Edge Rate ($\Delta t/\Delta V$) | |
| | | $V_{IN} = 0.8V$ to 2.0V, $V_{CC} = 3.0V$ | 10 ns/V |

Note 1: Absolute Maximum Ratings: are those values beyond which the safety of the device cannot be guaranteed. The device should not be operated at these limits. The parametric values defined in the Electrical Characteristics tables are not guaranteed at the absolute maximum ratings. The "Recommended Operating Conditions" table will define the conditions for actual device operation.

Note 2: I_O Absolute Maximum rating must be observed.

Note 3: Unused inputs must be held HIGH or LOW. They may not float.

DC Electrical Characteristics

| Symbol | Parameter | V_{CC} (V) | $T_A = +25^\circ C$ | | $T_A = -40^\circ C$ to $+85^\circ C$ | | Units | Conditions |
|------------------------------|------------------------------|------------------------------|---------------------|-----------------|--------------------------------------|-----------------|-------|----------------------|
| | | | Min | Max | Min | Max | | |
| V_{IH} | HIGH Level Input Voltage | 0.90 | 0.65 x V_{CC} | | 0.65 x V_{CC} | | V | |
| | | $1.10 \leq V_{CC} \leq 1.30$ | 0.65 x V_{CC} | | 0.65 x V_{CC} | | | |
| | | $1.40 \leq V_{CC} \leq 1.60$ | 0.65 x V_{CC} | | 0.65 x V_{CC} | | | |
| | | $1.65 \leq V_{CC} \leq 1.95$ | 0.65 x V_{CC} | | 0.65 x V_{CC} | | | |
| | | $2.30 \leq V_{CC} \leq 2.70$ | 1.6 | | 1.6 | | | |
| | | $3.00 \leq V_{CC} \leq 3.60$ | 2.1 | | 2.1 | | | |
| V_{IL} | LOW Level Input Voltage | 0.90 | | 0.35 x V_{CC} | | 0.35 x V_{CC} | V | |
| | | $1.10 \leq V_{CC} \leq 1.30$ | | 0.35 x V_{CC} | | 0.35 x V_{CC} | | |
| | | $1.40 \leq V_{CC} \leq 1.60$ | | 0.35 x V_{CC} | | 0.35 x V_{CC} | | |
| | | $1.65 \leq V_{CC} \leq 1.95$ | | 0.35 x V_{CC} | | 0.35 x V_{CC} | | |
| | | $2.30 \leq V_{CC} \leq 2.70$ | | 0.7 | | 0.7 | | |
| | | $3.00 \leq V_{CC} \leq 3.60$ | | 0.9 | 0.9 | | | |
| V_{OH} | HIGH Level Output Voltage | 0.90 | $V_{CC} - 0.1$ | | $V_{CC} - 0.1$ | | V | $I_{OH} = -20 \mu A$ |
| | | $1.10 \leq V_{CC} \leq 1.30$ | $V_{CC} - 0.1$ | | $V_{CC} - 0.1$ | | | |
| | | $1.40 \leq V_{CC} \leq 1.60$ | $V_{CC} - 0.1$ | | $V_{CC} - 0.1$ | | | |
| | | $1.65 \leq V_{CC} \leq 1.95$ | $V_{CC} - 0.1$ | | $V_{CC} - 0.1$ | | | |
| | | $2.30 \leq V_{CC} \leq 2.70$ | $V_{CC} - 0.1$ | | $V_{CC} - 0.1$ | | | |
| | | $3.00 \leq V_{CC} \leq 3.60$ | $V_{CC} - 0.1$ | | $V_{CC} - 0.1$ | | | |
| | | $1.10 \leq V_{CC} \leq 1.30$ | 0.75 x V_{CC} | | 0.70 x V_{CC} | | | |
| | | $1.40 \leq V_{CC} \leq 1.60$ | 1.07 | | 0.99 | | | |
| | | $1.65 \leq V_{CC} \leq 1.95$ | 1.24 | | 1.22 | | | |
| $2.30 \leq V_{CC} \leq 2.70$ | 1.95 | | 1.87 | | | | | |
| | | $3.00 \leq V_{CC} \leq 3.60$ | 2.61 | | 2.55 | | | |

DC Electrical Characteristics (Continued)

| Symbol | Parameter | V _{CC} (V) | T _A = +25°C | | T _A = -40°C to +85°C | | Units | Conditions |
|-------------------------------|-----------------------------|-------------------------------|------------------------|------------------------|---------------------------------|------------------------|-------|---|
| | | | Min | Max | Min | Max | | |
| V _{OL} | LOW Level Output Voltage | 0.90 | | 0.1 | | 0.1 | V | I _{OL} = 20 μA |
| | | 1.10 ≤ V _{CC} ≤ 1.30 | | 0.1 | | 0.1 | | |
| | | 1.40 ≤ V _{CC} ≤ 1.60 | | 0.1 | | 0.1 | | |
| | | 1.65 ≤ V _{CC} ≤ 1.95 | | 0.1 | | 0.1 | | |
| | | 2.30 ≤ V _{CC} ≤ 2.70 | | 0.1 | | 0.1 | | |
| | | 3.00 ≤ V _{CC} ≤ 3.60 | | 0.1 | | 0.1 | | |
| | | 1.10 ≤ V _{CC} ≤ 1.30 | | 0.30 x V _{CC} | | 0.30 x V _{CC} | | |
| | | 1.40 ≤ V _{CC} ≤ 1.60 | | 0.31 | | 0.37 | | |
| | | 1.65 ≤ V _{CC} ≤ 1.95 | | 0.31 | | 0.35 | | |
| 2.30 ≤ V _{CC} ≤ 2.70 | | 0.31 | | 0.33 | | | | |
| 3.00 ≤ V _{CC} ≤ 3.60 | | 0.31 | | 0.33 | | | | |
| I _{IN} | Input Leakage Current | 0.90 to 3.60 | | ±0.1 | | ±0.5 | μA | 0 ≤ V _I ≤ 3.6V |
| I _{OFF} | Power Off Leakage Current | 0 | | 0.5 | | 0.5 | μA | 0 ≤ (V _I , V _O) ≤ 3.6V |
| I _{CC} | Quiescent Supply Current | 0.90 to 3.60 | | 0.9 | | 0.9 | μA | V _I = V _{CC} or GND |

| AC Electrical Characteristics (10pF, 1MΩ) | | | | | | | | | | |
|---|---|-------------------------------|------------------------|------|------|---------------------------------|------|-------|---|---------------|
| Symbol | Parameter | V _{CC} (V) | T _A = +25°C | | | T _A = -40°C to +85°C | | Units | Conditions | Figure Number |
| | | | Min | Typ | Max | Min | Max | | | |
| f _{MAX} | Maximum Clock Frequency | 0.90 | | 40.0 | | | | MHz | C _L = 10 pF R _D = 1 MΩ | Figures 1, 5 |
| | | 1.10 ≤ V _{CC} ≤ 1.30 | 50 | | | 50 | | | | |
| | | 1.40 ≤ V _{CC} ≤ 1.60 | 75 | | | 75 | | | | |
| | | 1.65 ≤ V _{CC} ≤ 1.95 | 100 | | | 100 | | | | |
| | | 2.30 ≤ V _{CC} ≤ 2.70 | 125 | | | 125 | | | | |
| 3.00 ≤ V _{CC} ≤ 3.60 | 150 | | | 150 | | | | | | |
| t _{PLH} t _{PHL} | Propagation Delay CK to Q, \bar{Q} | 0.90 | | 24.0 | | | | ns | C _L = 10 pF R _D = 1 MΩ | Figures 1, 3 |
| | | 1.10 ≤ V _{CC} ≤ 1.30 | 4.0 | 15.0 | 22.0 | 3.5 | 31.0 | | | |
| | | 1.40 ≤ V _{CC} ≤ 1.60 | 2.0 | 9.0 | 13.0 | 1.5 | 14.0 | | | |
| | | 1.65 ≤ V _{CC} ≤ 1.95 | 1.5 | 7.0 | 11.0 | 1.0 | 13.0 | | | |
| | | 2.30 ≤ V _{CC} ≤ 2.70 | 1.0 | 5.0 | 8.0 | 0.8 | 9.0 | | | |
| 3.00 ≤ V _{CC} ≤ 3.60 | 1.0 | 4.0 | 7.0 | 0.5 | 8.0 | | | | | |
| t _{PLH} t _{PHL} | Propagation Delay $\overline{\text{CLR}}$, $\overline{\text{PR}}$, to Q, \bar{Q} | 0.90 | | 6.5 | | | | ns | C _L = 10 pF R _D = 1 MΩ | Figures 1, 3 |
| | | 1.10 ≤ V _{CC} ≤ 1.30 | 4.0 | 12.0 | 23.0 | 4.0 | 34.0 | | | |
| | | 1.40 ≤ V _{CC} ≤ 1.60 | 2.0 | 9.0 | 12.0 | 2.0 | 14.0 | | | |
| | | 1.65 ≤ V _{CC} ≤ 1.95 | 1.5 | 7.0 | 11.0 | 1.5 | 13.0 | | | |
| | | 2.30 ≤ V _{CC} ≤ 2.70 | 1.0 | 5.0 | 9.0 | 1.0 | 9.0 | | | |
| 3.00 ≤ V _{CC} ≤ 3.60 | 1.0 | 4.0 | 7.0 | 1.0 | 8.0 | | | | | |
| t _S | Setup Time, CK to D | 0.90 | | 10.0 | | | | ns | C _L = 10 pF R _D = 1 MΩ | Figures 1, 4 |
| | | 1.10 ≤ V _{CC} ≤ 1.30 | 7.0 | | | 7.0 | | | | |
| | | 1.40 ≤ V _{CC} ≤ 1.60 | 3.0 | | | 3.0 | | | | |
| | | 1.65 ≤ V _{CC} ≤ 1.95 | 2.0 | | | 2.0 | | | | |
| | | 2.30 ≤ V _{CC} ≤ 2.70 | 1.5 | | | 1.5 | | | | |
| 3.00 ≤ V _{CC} ≤ 3.60 | 1.0 | | | 1.0 | | | | | | |
| t _H | Hold Time, CK to D | 0.90 | | 1.0 | | | | ns | C _L = 10 pF R _D = 1 MΩ | Figures 1, 4 |
| | | 1.10 ≤ V _{CC} ≤ 1.30 | 0.5 | | | 0.5 | | | | |
| | | 1.40 ≤ V _{CC} ≤ 1.60 | 0.5 | | | 0.5 | | | | |
| | | 1.65 ≤ V _{CC} ≤ 1.95 | 0.5 | | | 0.5 | | | | |
| | | 2.30 ≤ V _{CC} ≤ 2.70 | 0.5 | | | 0.5 | | | | |
| 3.00 ≤ V _{CC} ≤ 3.60 | 0.5 | | | 0.5 | | | | | | |
| t _W | Pulse Width, CK, $\overline{\text{PR}}$, $\overline{\text{CLR}}$ | 0.90 | | 5.0 | | | | ns | C _L = 10 pF R _D = 1 MΩ | Figures 1, 5 |
| | | 1.10 ≤ V _{CC} ≤ 1.30 | 5.0 | | | 5.0 | | | | |
| | | 1.40 ≤ V _{CC} ≤ 1.60 | 3.0 | | | 3.0 | | | | |
| | | 1.65 ≤ V _{CC} ≤ 1.95 | 2.5 | | | 2.5 | | | | |
| | | 2.30 ≤ V _{CC} ≤ 2.70 | 2.5 | | | 2.5 | | | | |
| 3.00 ≤ V _{CC} ≤ 3.60 | 2.0 | | | 2.0 | | | | | | |
| t _{REC} | Recover Time $\overline{\text{CLR}}$, $\overline{\text{PR}}$ to CK | 0.90 | | 12.0 | | | | ns | C _L = 10 pF R _D = 1 MΩ | Figures 1, 4 |
| | | 1.10 ≤ V _{CC} ≤ 1.30 | 8.5 | | | 8.5 | | | | |
| | | 1.40 ≤ V _{CC} ≤ 1.60 | 3.5 | | | 3.5 | | | | |
| | | 1.65 ≤ V _{CC} ≤ 1.95 | 3.0 | | | 3.0 | | | | |
| | | 2.30 ≤ V _{CC} ≤ 2.70 | 2.5 | | | 2.5 | | | | |
| 3.00 ≤ V _{CC} ≤ 3.60 | 2.0 | | | 2.0 | | | | | | |

| AC Electrical Characteristics (15pF, 1MΩ) | | | | | | | | | | |
|---|---|-------------------------------|------------------------|------|------|---------------------------------|------|-------|---|---------------|
| Symbol | Parameter | V _{CC} (V) | T _A = +25°C | | | T _A = -40°C to +85°C | | Units | Conditions | Figure Number |
| | | | Min | Typ | Max | Min | Max | | | |
| f _{MAX} | Maximum Clock Frequency | 0.90 | | 40.0 | | | | MHz | C _L = 15 pF R _D = 1 MΩ | Figures 1, 5 |
| | | 1.10 ≤ V _{CC} ≤ 1.30 | 50 | | | 150 | | | | |
| | | 1.40 ≤ V _{CC} ≤ 1.60 | 75 | | | 200 | | | | |
| | | 1.65 ≤ V _{CC} ≤ 1.95 | 100 | | | 250 | | | | |
| | | 2.30 ≤ V _{CC} ≤ 2.70 | 125 | | | 175 | | | | |
| 3.00 ≤ V _{CC} ≤ 3.60 | 150 | | | 200 | | | | | | |
| t _{PLH} t _{PHL} | Propagation Delay CK to Q, \bar{Q} | 0.90 | | 27.0 | | | | ns | C _L = 15 pF R _D = 1 MΩ | Figures 1, 3 |
| | | 1.10 ≤ V _{CC} ≤ 1.30 | 5.0 | 16.0 | 23.0 | 4.5 | 34.0 | | | |
| | | 1.40 ≤ V _{CC} ≤ 1.60 | 3.0 | 10.0 | 14.0 | 2.5 | 16.0 | | | |
| | | 1.65 ≤ V _{CC} ≤ 1.95 | 2.0 | 7.0 | 11.0 | 2.0 | 13.0 | | | |
| | | 2.30 ≤ V _{CC} ≤ 2.70 | 1.5 | 5.0 | 8.0 | 1.0 | 9.0 | | | |
| 3.00 ≤ V _{CC} ≤ 3.60 | 1.0 | 4.0 | 7.0 | 0.5 | 8.0 | | | | | |
| t _{PLH} t _{PHL} | Propagation Delay \overline{CLR} , \overline{PR} , to Q, \bar{Q} | 0.90 | | 27.0 | | | | ns | C _L = 15 pF R _D = 1 MΩ | Figures 1, 3 |
| | | 1.10 ≤ V _{CC} ≤ 1.30 | 5.0 | 15.0 | 24.0 | 5.0 | 37.0 | | | |
| | | 1.40 ≤ V _{CC} ≤ 1.60 | 3.0 | 10.0 | 13.0 | 3.0 | 16.0 | | | |
| | | 1.65 ≤ V _{CC} ≤ 1.95 | 2.0 | 7.0 | 11.0 | 2.0 | 13.0 | | | |
| | | 2.30 ≤ V _{CC} ≤ 2.70 | 1.5 | 5.0 | 9.0 | 1.5 | 9.0 | | | |
| 3.00 ≤ V _{CC} ≤ 3.60 | 1.0 | 4.0 | 7.0 | 1.0 | 8.0 | | | | | |
| t _S | Setup Time, CK to D | 0.90 | | 10.0 | | | | ns | C _L = 15 pF R _D = 1 MΩ | Figures 1, 4 |
| | | 1.10 ≤ V _{CC} ≤ 1.30 | 7.0 | | | 7.0 | | | | |
| | | 1.40 ≤ V _{CC} ≤ 1.60 | 3.0 | | | 3.0 | | | | |
| | | 1.65 ≤ V _{CC} ≤ 1.95 | 2.0 | | | 2.0 | | | | |
| | | 2.30 ≤ V _{CC} ≤ 2.70 | 1.5 | | | 1.5 | | | | |
| 3.00 ≤ V _{CC} ≤ 3.60 | 1.0 | | | 1.0 | | | | | | |
| t _H | Hold Time, CK to D | 0.90 | | 1.0 | | | | ns | C _L = 15 pF R _D = 1 MΩ | Figures 1, 4 |
| | | 1.10 ≤ V _{CC} ≤ 1.30 | 0.5 | | | 0.5 | | | | |
| | | 1.40 ≤ V _{CC} ≤ 1.60 | 0.5 | | | 0.5 | | | | |
| | | 1.65 ≤ V _{CC} ≤ 1.95 | 0.5 | | | 0.5 | | | | |
| | | 2.30 ≤ V _{CC} ≤ 2.70 | 0.5 | | | 0.5 | | | | |
| 3.00 ≤ V _{CC} ≤ 3.60 | 0.5 | | | 0.5 | | | | | | |
| t _W | Pulse Width, CK, \overline{PR} , \overline{CLR} | 0.90 | | 5.0 | | | | ns | C _L = 15 pF R _D = 1 MΩ | Figures 1, 5 |
| | | 1.10 ≤ V _{CC} ≤ 1.30 | 5.0 | | | 5.0 | | | | |
| | | 1.40 ≤ V _{CC} ≤ 1.60 | 3.0 | | | 3.0 | | | | |
| | | 1.65 ≤ V _{CC} ≤ 1.95 | 2.5 | | | 2.5 | | | | |
| | | 2.30 ≤ V _{CC} ≤ 2.70 | 2.5 | | | 2.5 | | | | |
| 3.00 ≤ V _{CC} ≤ 3.60 | 2.0 | | | 2.0 | | | | | | |
| t _{REC} | Recover Time \overline{CLR} , \overline{PR} to CK | 0.90 | | 12.0 | | | | ns | C _L = 15 pF R _D = 1 MΩ | Figures 1, 4 |
| | | 1.10 ≤ V _{CC} ≤ 1.30 | 8.5 | | | 8.5 | | | | |
| | | 1.40 ≤ V _{CC} ≤ 1.60 | 3.5 | | | 3.5 | | | | |
| | | 1.65 ≤ V _{CC} ≤ 1.95 | 3.0 | | | 3.0 | | | | |
| | | 2.30 ≤ V _{CC} ≤ 2.70 | 2.5 | | | 2.5 | | | | |
| 3.00 ≤ V _{CC} ≤ 3.60 | 2.0 | | | 2.0 | | | | | | |

| AC Electrical Characteristics (30pF, 1MΩ) | | | | | | | | | | |
|---|---|-------------------------------|------------------------|------|------|---------------------------------|------|-------|---|---------------|
| Symbol | Parameter | V _{CC} (V) | T _A = +25°C | | | T _A = -40°C to +85°C | | Units | Conditions | Figure Number |
| | | | Min | Typ | Max | Min | Max | | | |
| f _{MAX} | Maximum Clock Frequency | 0.90 | | 40.0 | | | | MHz | C _L = 30 pF R _D = 1 MΩ | Figures 1, 5 |
| | | 1.10 ≤ V _{CC} ≤ 1.30 | 50 | | | 150 | | | | |
| | | 1.40 ≤ V _{CC} ≤ 1.60 | 75 | | | 200 | | | | |
| | | 1.65 ≤ V _{CC} ≤ 1.95 | 100 | | | 250 | | | | |
| | | 2.30 ≤ V _{CC} ≤ 2.70 | 125 | | | 175 | | | | |
| 3.00 ≤ V _{CC} ≤ 3.60 | 150 | | | 200 | | | | | | |
| t _{PLH} t _{PHL} | Propagation Delay CK to Q, \bar{Q} | 0.90 | | 34.0 | | | | ns | C _L = 30 pF R _D = 1 MΩ | Figures 1, 3 |
| | | 1.10 ≤ V _{CC} ≤ 1.30 | 6.0 | 18.0 | 27.0 | 5.0 | 43.0 | | | |
| | | 1.40 ≤ V _{CC} ≤ 1.60 | 4.0 | 11.0 | 17.0 | 3.0 | 18.0 | | | |
| | | 1.65 ≤ V _{CC} ≤ 1.95 | 2.0 | 8.0 | 13.0 | 2.0 | 15.0 | | | |
| | | 2.30 ≤ V _{CC} ≤ 2.70 | 1.0 | 6.0 | 10.0 | 1.0 | 11.0 | | | |
| 3.00 ≤ V _{CC} ≤ 3.60 | 0.8 | 5.0 | 8.0 | 0.5 | 10.0 | | | | | |
| t _{PLH} t _{PHL} | Propagation Delay $\overline{\text{CLR}}$, $\overline{\text{PR}}$, to Q, \bar{Q} | 0.90 | | 34.0 | | | | ns | C _L = 30 pF R _D = 1 MΩ | Figures 1, 3 |
| | | 1.10 ≤ V _{CC} ≤ 1.30 | 6.0 | 17.0 | 28.0 | 5.5 | 46.0 | | | |
| | | 1.40 ≤ V _{CC} ≤ 1.60 | 4.0 | 11.0 | 16.0 | 3.5 | 18.0 | | | |
| | | 1.65 ≤ V _{CC} ≤ 1.95 | 2.0 | 8.0 | 13.0 | 2.5 | 15.0 | | | |
| | | 2.30 ≤ V _{CC} ≤ 2.70 | 1.0 | 6.0 | 9.0 | 1.5 | 11.0 | | | |
| 3.00 ≤ V _{CC} ≤ 3.60 | 0.8 | 5.0 | 8.0 | 1.0 | 10.0 | | | | | |
| t _S | Setup Time, CK to D | 0.90 | | 10.0 | | | | ns | C _L = 30 pF R _D = 1 MΩ | Figures 1, 4 |
| | | 1.10 ≤ V _{CC} ≤ 1.30 | 7.0 | | | 7.0 | | | | |
| | | 1.40 ≤ V _{CC} ≤ 1.60 | 3.0 | | | 3.0 | | | | |
| | | 1.65 ≤ V _{CC} ≤ 1.95 | 2.0 | | | 2.0 | | | | |
| | | 2.30 ≤ V _{CC} ≤ 2.70 | 1.5 | | | 1.5 | | | | |
| 3.00 ≤ V _{CC} ≤ 3.60 | 1.0 | | | 1.0 | | | | | | |
| t _H | Hold Time, CK to D | 0.90 | | 1.0 | | | | ns | C _L = 30 pF R _D = 1 MΩ | Figures 1, 4 |
| | | 1.10 ≤ V _{CC} ≤ 1.30 | 0.5 | | | 0.5 | | | | |
| | | 1.40 ≤ V _{CC} ≤ 1.60 | 0.5 | | | 0.5 | | | | |
| | | 1.65 ≤ V _{CC} ≤ 1.95 | 0.5 | | | 0.5 | | | | |
| | | 2.30 ≤ V _{CC} ≤ 2.70 | 0.5 | | | 0.5 | | | | |
| 3.00 ≤ V _{CC} ≤ 3.60 | 0.5 | | | 0.5 | | | | | | |
| t _W | Pulse Width, CK, $\overline{\text{PR}}$, $\overline{\text{CLR}}$ | 0.90 | | 5.0 | | | | ns | C _L = 30 pF R _D = 1 MΩ | Figures 1, 5 |
| | | 1.10 ≤ V _{CC} ≤ 1.30 | 5.0 | | | 4.0 | | | | |
| | | 1.40 ≤ V _{CC} ≤ 1.60 | 3.0 | | | 3.0 | | | | |
| | | 1.65 ≤ V _{CC} ≤ 1.95 | 2.5 | | | 2.0 | | | | |
| | | 2.30 ≤ V _{CC} ≤ 2.70 | 2.5 | | | 3.0 | | | | |
| 3.00 ≤ V _{CC} ≤ 3.60 | 2.0 | | | 2.0 | | | | | | |
| t _{REC} | Recover Time $\overline{\text{CLR}}$, $\overline{\text{PR}}$ to CK | 0.90 | | 12.0 | | | | ns | C _L = 30 pF R _D = 1 MΩ | Figures 1, 4 |
| | | 1.10 ≤ V _{CC} ≤ 1.30 | 8.5 | | | 8.5 | | | | |
| | | 1.40 ≤ V _{CC} ≤ 1.60 | 3.5 | | | 3.5 | | | | |
| | | 1.65 ≤ V _{CC} ≤ 1.95 | 3.0 | | | 3.0 | | | | |
| | | 2.30 ≤ V _{CC} ≤ 2.70 | 2.5 | | | 2.5 | | | | |
| 3.00 ≤ V _{CC} ≤ 3.60 | 2.0 | | | 2.0 | | | | | | |

| Capacitance | | | | | | |
|------------------|-------------------------------|-----|-----|-------|--|---------------|
| Symbol | Parameter | Typ | Max | Units | Conditions | Figure Number |
| C _{IN} | Input Capacitance | 2.0 | | pF | V _{CC} = 0V | |
| C _{OUT} | Output Capacitance | 4.0 | | pF | V _{CC} = 0V | |
| C _{PD} | Power Dissipation Capacitance | 8.0 | | pF | V _I = 0V or V _{CC} f = 10 MHz | Figure 2 |

AC Loading and Waveforms

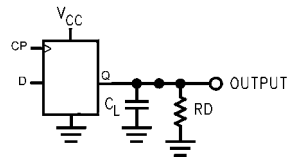

C_L includes load and stray capacitance
 Input PRR = 1.0 MHz; $t_w = 500$ ns

FIGURE 1. AC Test Circuit

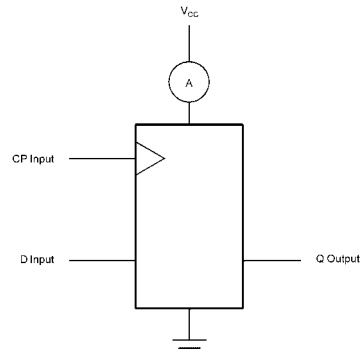

CP Input = AC Waveform; $t_r = t_f = 2.5$ ns;
 CP Input PRR = 10 MHz; Duty Cycle = 50%
 D Input PRR = 5MHz; Duty Cycle = 50%

FIGURE 2. I_{CCD} Test Circuit

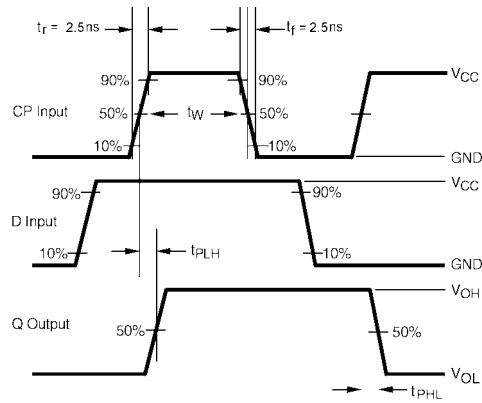

FIGURE 3. AC Waveforms

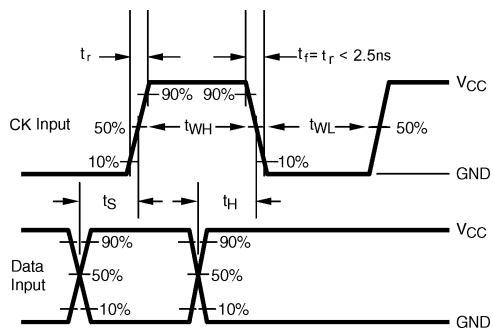

FIGURE 4. AC Waveforms

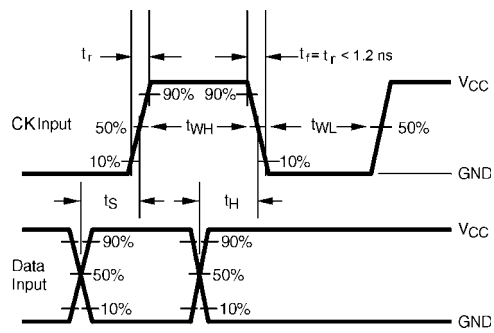

FIGURE 5. AC Waveforms

Tape and Reel Specification

TAPE FORMAT for US8

| Package Designator | Tape Section | Number Cavities | Cavity Status | Cover Tape Status |
|--------------------|--------------------|-----------------|---------------|-------------------|
| K8X | Leader (Start End) | 125 (typ) | Empty | Sealed |
| | Carrier | 3000 | Filled | Sealed |
| | Trailer (Hub End) | 75 (typ) | Empty | Sealed |

TAPE DIMENSIONS inches (millimeters)

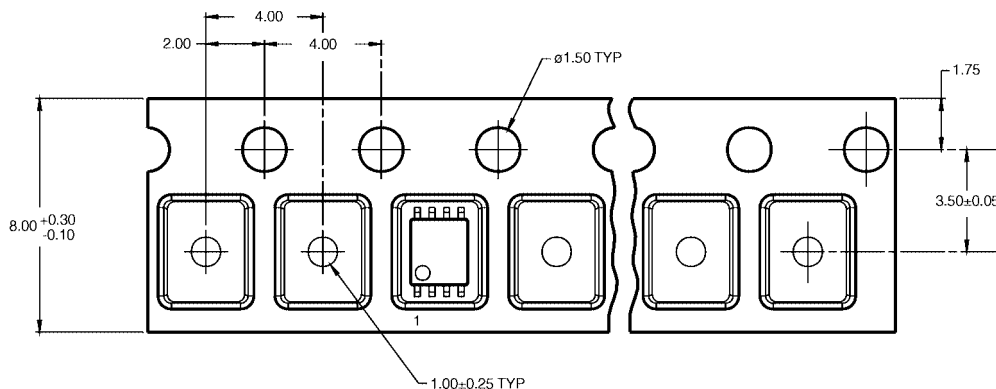

TAPE FORMAT for MicroPak

| Package Designator | Tape Section | Number Cavities | Cavity Status | Cover Tape Status |
|--------------------|--------------------|-----------------|---------------|-------------------|
| L8X | Leader (Start End) | 125 (typ) | Empty | Sealed |
| | Carrier | 3000 | Filled | Sealed |
| | Trailer (Hub End) | 75 (typ) | Empty | Sealed |

TAPE DIMENSIONS inches (millimeters)

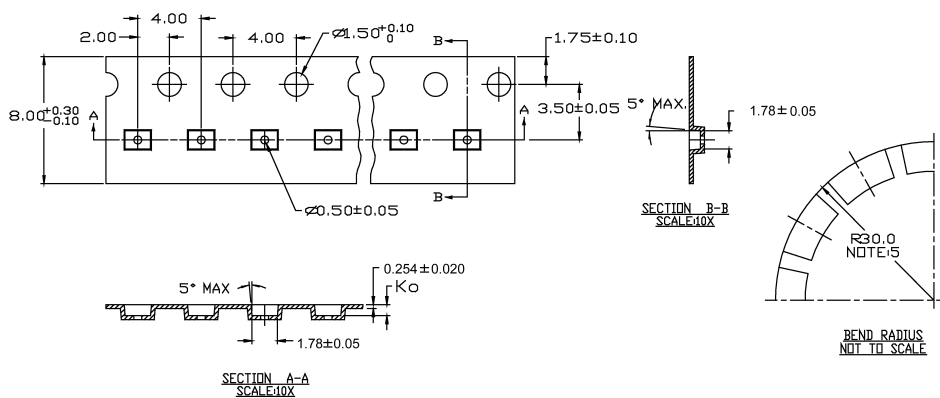

Tape and Reel Specification (Continued)
REEL DIMENSIONS inches (millimeters)

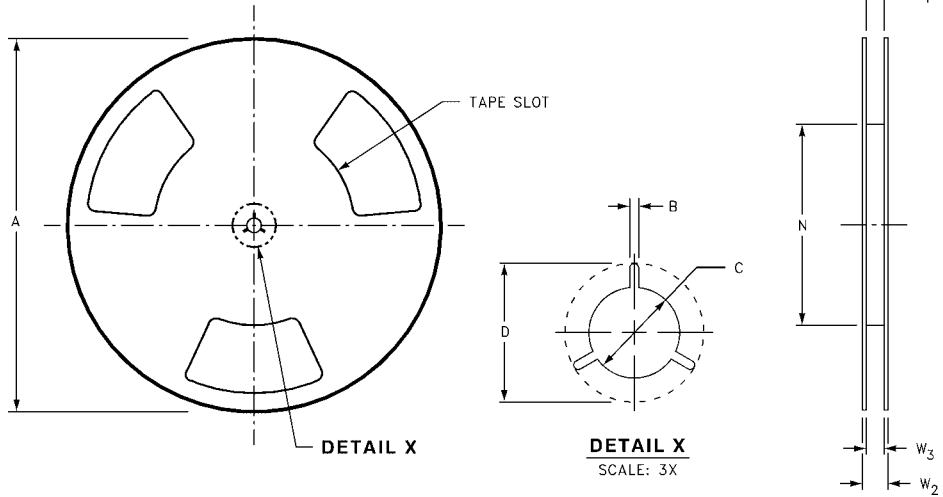

| Tape Size | A | B | C | D | N | W1 | W2 | W3 |
|-----------|----------------|-----------------|------------------|------------------|------------------|---|------------------|--|
| 8 mm | 7.0 (177.8) | 0.059 (1.50) | 0.512 (13.00) | 0.795 (20.20) | 2.165 (55.00) | $0.331 + 0.059/-0.000$ ($8.40 + 1.50/-0.00$) | 0.567 (14.40) | $W1 + 0.078/-0.039$ ($W1 + 2.00/-1.00$) |

Physical Dimensions inches (millimeters) unless otherwise noted

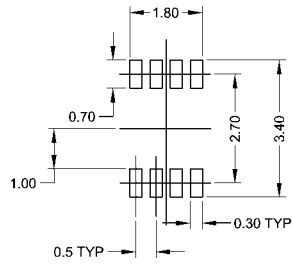
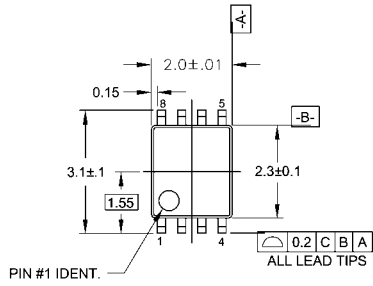

LAND PATTERN RECOMMENDATION

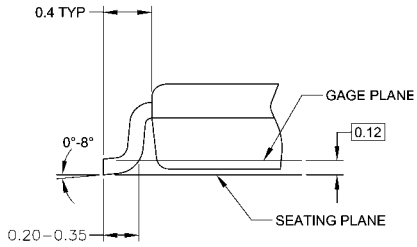
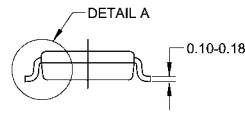
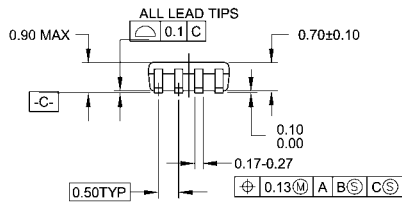

DETAIL A

NOTES:

- A. CONFORMS TO JEDEC REGISTRATION MO-187
- B. DIMENSIONS ARE IN MILLIMETERS.
- C. DIMENSIONS ARE EXCLUSIVE OF BURRS, MOLD FLASH, AND TIE BAR EXTRUSIONS.
- D. DIMENSIONS AND TOLERANCES PER ANSI Y14.5M, 1982.

MAB08AREVC

**8-Lead US8, JEDEC MO-187, Variation CA 3.1mm Wide
Package Number MAB08A**

Physical Dimensions inches (millimeters) unless otherwise noted (Continued)

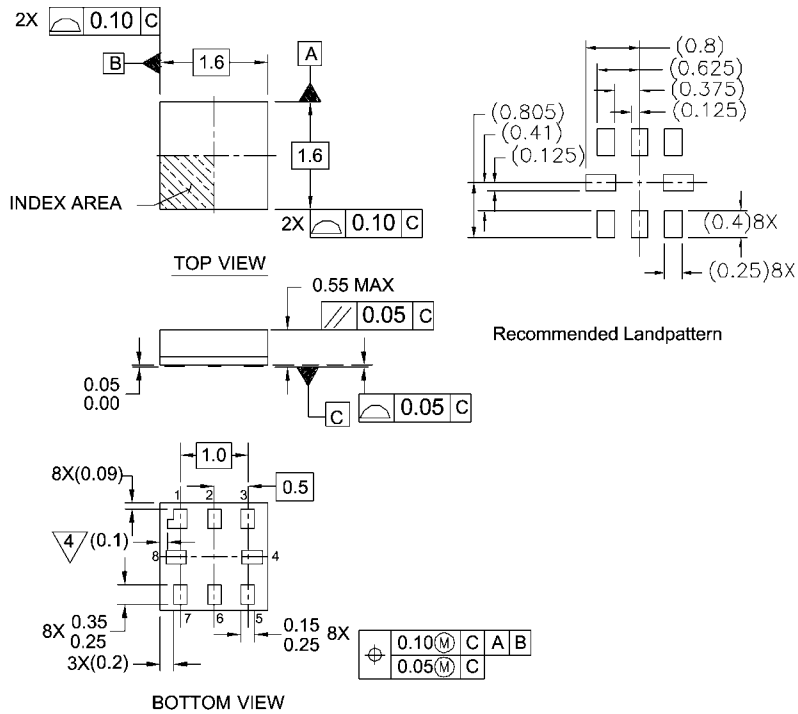

Notes:

1. PACKAGE CONFORMS TO JEDEC MO-255 VARIATION UAAD
2. DIMENSIONS ARE IN MILLIMETERS
3. DRAWING CONFORMS TO ASME Y.14M-1994
4. PIN 1 FLAG, END OF PACKAGE OFFSET.

MAC08AREVC

**Pb-Free 8-Lead MicroPak, 1.6 mm Wide
Package Number MAC08A**

Fairchild does not assume any responsibility for use of any circuitry described, no circuit patent licenses are implied and Fairchild reserves the right at any time without notice to change said circuitry and specifications.

LIFE SUPPORT POLICY

FAIRCHILD'S PRODUCTS ARE NOT AUTHORIZED FOR USE AS CRITICAL COMPONENTS IN LIFE SUPPORT DEVICES OR SYSTEMS WITHOUT THE EXPRESS WRITTEN APPROVAL OF THE PRESIDENT OF FAIRCHILD SEMICONDUCTOR CORPORATION. As used herein:

1. Life support devices or systems are devices or systems which, (a) are intended for surgical implant into the body, or (b) support or sustain life, and (c) whose failure to perform when properly used in accordance with instructions for use provided in the labeling, can be reasonably expected to result in a significant injury to the user.
2. A critical component in any component of a life support device or system whose failure to perform can be reasonably expected to cause the failure of the life support device or system, or to affect its safety or effectiveness.

www.fairchildsemi.com