

J-FET INPUT DUAL OP-AMPs

- LOW POWER CONSUMPTION
- WIDE COMMON-MODE AND DIFFERENTIAL VOLTAGE RANGE
- LOW INPUT BIAS AND OFFSET CURRENT
- OUTPUT SHORT-CIRCUIT PROTECTION
- HIGH INPUT IMPEDANCE J-FET INPUT STAGE
- INTERNAL FREQUENCY COMPENSATION
- LATCH UP FREE OPERATION
- HIGH SLEW RATE : 13 V/ μ s (typ)

DESCRIPTION

These circuits are high speed J-FET input dual operational amplifiers incorporating well matched, high voltage J-FET and bipolar transistors in a monolithic integrated circuit.

The devices feature high slew rates, low input bias and offset current, and low offset voltage temperature coefficient.

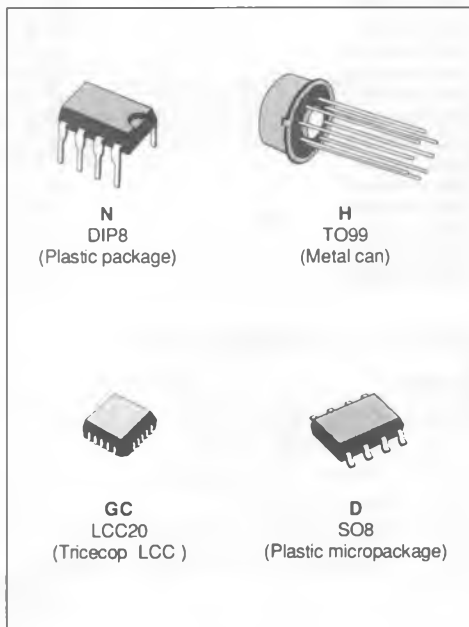

PIN CONNECTIONS (Top views)

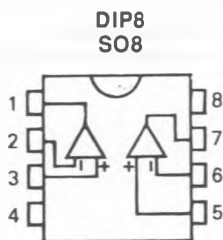

- 1 - Output 1
- 2 - Inverting input 1
- 3 - Non-inverting input 1
- 4 - V_{CC}
- 5 - Non-inverting input 2
- 6 - Inverting input 2
- 7 - Output 2
- 8 - V_{CC}

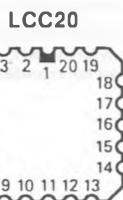
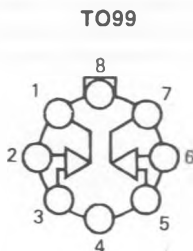

- | | |
|---------------------------|----------------------------|
| 1 - NC | 11 - NC |
| 2 - Output 1 | 12 - Non-inverting input 2 |
| 3 - NC | 13 - NC |
| 4 - NC | 14 - NC |
| 5 - Inverting input 1 | 15 - Inverting input 2 |
| 6 - NC | 16 - NC |
| 7 - Non-inverting input 1 | 17 - Output 2 |
| 8 - NC | 18 - NC |
| 9 - NC | 19 - NC |
| 10 - V_{CC} | 20 - V_{CC} |

ORDER CODES

Part Number	Temperature	Package
MC35002GC	- 55 °C to + 125 °C	LCC
MC35002AGC	- 55 °C to + 125 °C	LCC
MC35002BGC	- 55 °C to + 125 °C	LCC
MC35002H	- 55 °C to + 125 °C	METAL CAN
MC35002AH	- 55 °C to + 125 °C	METAL CAN
MC35002BH	- 55 °C to + 125 °C	METAL CAN
MC33002N	- 40 °C to + 105 °C	DIP8
MC33002AN	- 40 °C to + 105 °C	DIP8
MC33002BN	- 40 °C to + 105 °C	DIP8
MC33002D	- 40 °C to + 105 °C	SO8
MC33002AD	- 40 °C to + 105 °C	SO8
MC33002BD	- 40 °C to + 105 °C	SO8
MC34002N	0 °C to + 70 °C	DIP8
MC34002AN	0 °C to + 70 °C	DIP8
MC34002BN	0 °C to + 70 °C	DIP8
MC34002D	0 °C to + 70 °C	SO8
MC34002AD	0 °C to + 70 °C	SO8
MC34002BD	0 °C to + 70 °C	SO8

ABSOLUTE MAXIMUM RATINGS

Symbol	Parameter	Value	Unit
V_{CC}	Supply Voltage (note 1)	± 18	V
V_I	Input Voltage (note 3)	± 15	V
V_{CC}	Diff. Input Voltage (note 2)	± 30	V
P_{tot}	Power Dissipation	680	mW
	Output Short-circuit Duration (note 4)	Infinite	
T_{oper}	Operating Free Air Temperature Range	MC34002, A, B MC33002, A, B MC35002, A, B	°C
T_{stg}	Storage Temperature Range	- 65 to 150	°C

- Notes :
1. All voltage values, except differential voltage, are with respect to the zero reference level (ground) of the supply voltages where the zero reference level is the midpoint between V_{CC} and V_{CC} .
 2. Differential voltages are at the non-inverting input terminal with respect to the inverting input terminal.
 3. The magnitude of the input voltage must never exceed the magnitude of the supply voltage or 15 volts, whichever is less.
 4. The output may be shorted to ground or to either supply. Temperature and/or supply voltages must be limited to ensure that the dissipation rating is not exceeded.

SCHEMATIC DIAGRAM

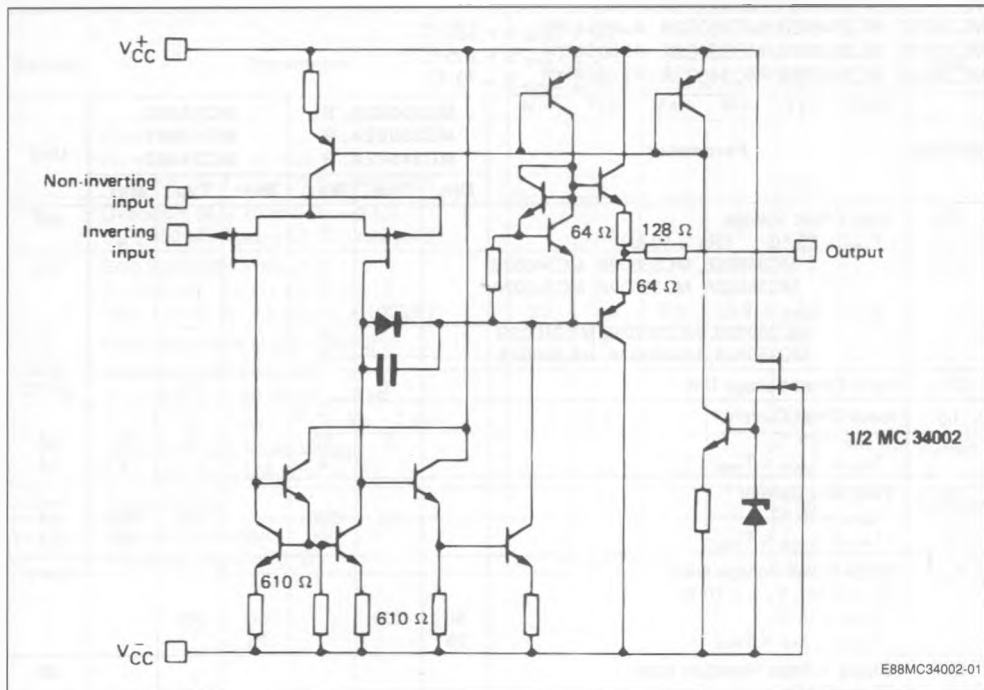

Case	Outputs	Non-inverting Inputs	Inverting Inputs	V_{CC}	V_{CC}	N.C.
DIP8 SO8 TO99	1, 7	3, 5	2, 6	4	8	
LCC20	2, 17	7, 12	5, 15	10	20	*

* LCC20 : Other pins are not connected.

ELECTRICAL CHARACTERISTICS

$V_{CC} = \pm 15\text{ V}$ (unless otherwise specified)

MC35002, MC35002B, MC35002A $-55 \leq T_{amb} \leq +125\text{ }^{\circ}\text{C}$

MC33002, MC33002B, MC33002A $-40 \leq T_{amb} \leq +105\text{ }^{\circ}\text{C}$

MC34002, MC34002B, MC34002A $0 \leq T_{amb} \leq +70\text{ }^{\circ}\text{C}$

Symbol	Parameter	MC35002A, B MC33002A, B MC34002A, B			MC35002 MC33002 MC34002			Unit
		Min.	Typ.	Max.	Min.	Typ.	Max.	
V_{IO}	Input Offset Voltage $T_{amb} = 25\text{ }^{\circ}\text{C}$ ($R_S < 10\text{ k}\Omega$) MC35002B, MC33002B, MC34002B MC35002A, MC33002A, MC34002A $T_{min} \leq T_{amb} \leq T_{max}$ MC35002B, MC33002B, MC34002B MC35002A, MC33002A, MC34002A		3 1	5 2		3	8 13	mV
DV_{IO}	Input Offset Voltage Drift		10			10		$\mu\text{V}/^{\circ}\text{C}$
I_{IO}	Input Offset Current * $T_{amb} = 25\text{ }^{\circ}\text{C}$ $T_{min} \leq T_{amb} \leq T_{max}$		5	50 4		5	50 4	pA nA
I_{IB}	Input Bias Current * $T_{amb} = 25\text{ }^{\circ}\text{C}$ $T_{min} \leq T_{amb} \leq T_{max}$		20	200 20		20	200 20	pA nA
A_{VD}	Large Signal Voltage Gain ($R_L \geq 2\text{ k}\Omega$, $V_O = \pm 10\text{ V}$) $T_{amb} = 25\text{ }^{\circ}\text{C}$ $T_{min} \leq T_{amb} \leq T_{max}$	50 25	200		50 25	200		V/mV
SVR	Supply Voltage Rejection Ratio ($R_S < 10\text{ k}\Omega$) $T_{amb} = 25\text{ }^{\circ}\text{C}$ $T_{min} \leq T_{amb} \leq T_{max}$	80 80	86		80 80	86		dB
I_{CC}	Supply Current, per Amp, no Load $T_{amb} = 25\text{ }^{\circ}\text{C}$ $T_{min} \leq T_{amb} \leq T_{max}$		1.4	2.5 2.5		1.4	2.5 2.5	mA
V_I	Input Voltage Range $T_{amb} = 25\text{ }^{\circ}\text{C}$ $T_{min} \leq T_{amb} \leq T_{max}$	- 11		+ 11	- 11		+ 11	V
CMR	Common Mode Rejection Ratio ($R_S \leq 10\text{ k}\Omega$) $T_{amb} = 25\text{ }^{\circ}\text{C}$ $T_{min} \leq T_{amb} \leq T_{max}$	80 80	86		70 70	86		dB
I_{OS}	Output Short-circuit Current $T_{amb} = 25\text{ }^{\circ}\text{C}$ $T_{min} \leq T_{amb} \leq T_{max}$	10 10	40	60 60	10 10	40	60 60	mA
$\pm V_{OPP}$	Output Voltage Swing $T_{amb} = 25\text{ }^{\circ}\text{C}$ $T_{min} \leq T_{amb} \leq T_{max}$		$R_L \geq 2\text{ k}\Omega$ 11 $R_L \geq 10\text{ k}\Omega$ 12 $R_L \geq 2\text{ k}\Omega$ 11 $R_L \geq 10\text{ k}\Omega$ 12	12 13.5		$R_L \geq 2\text{ k}\Omega$ 11 $R_L \geq 10\text{ k}\Omega$ 12	12 13.5	V
S_{VO}	Slew-rate ($V_I = 10\text{ V}$, $R_L = 2\text{ k}\Omega$) $C_L \leq 100\text{ pF}$, $T_{amb} = 25\text{ }^{\circ}\text{C}$, unity gain	12	16		12	16		V/ μs

* The input bias currents are junction leakage currents which approximately double for every 10 °C increase in the junction temperature.

ELECTRICAL CHARACTERISTICS (continued)

Symbol	Parameter	MC34002A, B MC33002A, B MC35002A, B			MC34002 MC33002 MC35002			Unit
		Min.	Typ.	Max.	Min.	Typ.	Max.	
t_r	Rise Time ($V_i = 20$ mV, $R_L = 2$ k Ω) $C_L = 100$ pF, $T_{amb} = 25$ °C, unity Gain		0.1			0.1		μ s
K_{OV}	Overshoot ($V_i = 20$ mV, $R_L = 2$ k Ω) $C_L \leq 100$ pF, $T_{amb} = 25$ °C, unity gain)		10			10		%
GBP	Gain Bandwidth Product ($f = 100$ kHz, $T_{amb} = 25$ °C) $V_{IN} = 10$ mV, $R_L = 2$ k Ω , $C_L = 100$ pF)	3.3	4.0	5.0	3.3	4.0	5.0	MHz
R_i	Input Resistance ($T_{amb} = 25$ °C)		10^{12}			10^{12}		Ω
THD	Total Harmonic Distortion ($f = 1$ kHz, $A_v = 20$ dB, $R_L = 2$ k Ω) $C_L \leq 100$ pF, $T_{amb} = 25$ °C, $V_O = 2$ V _{PP})		0.01			0.01		%
V_n	Equivalent Input Noise Voltage ($f = 1$ kHz, $R_g = 100$ Ω)		15			15		nV/ \sqrt Hz
ϕ_m	Phase Margin		45			45		Degrees
V_{O1}/V_{O2}	Channel Separation $A_{VD} = 100$, $T_{amb} = 25$ °C		120			120		dB

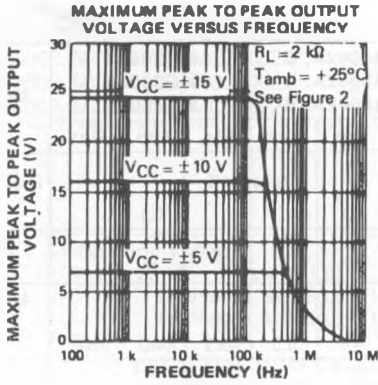

E88MC34002.02

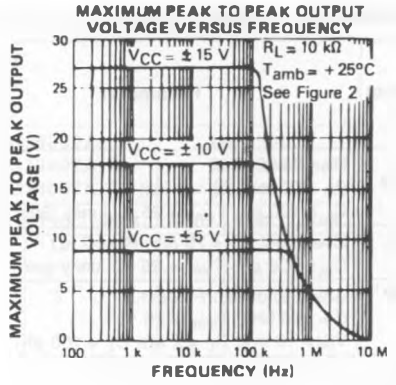

E88MC34002.03

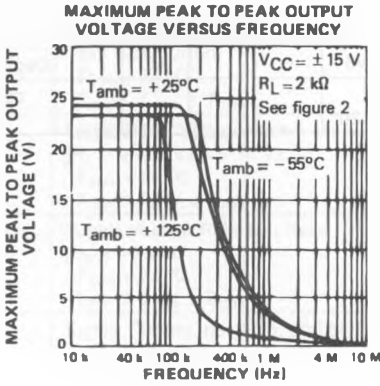

E88MC34002.04

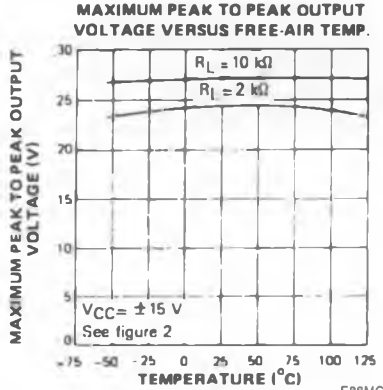

E88MC34002.05

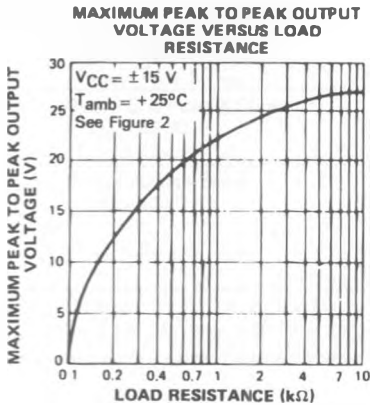

E88MC34002.06

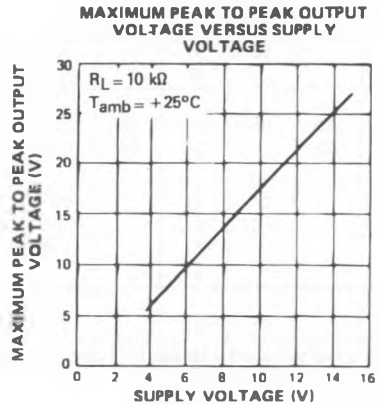

E88MC34002.07

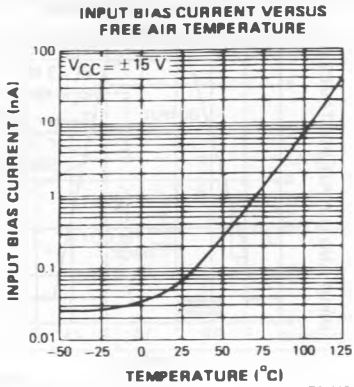

E88MC34002-08

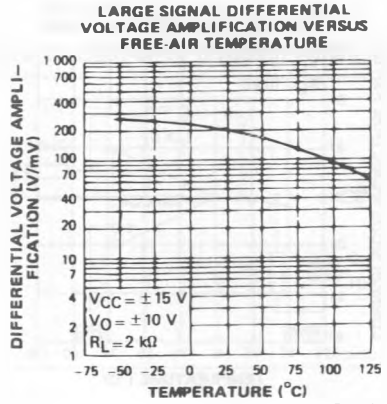

E88MC34002-09

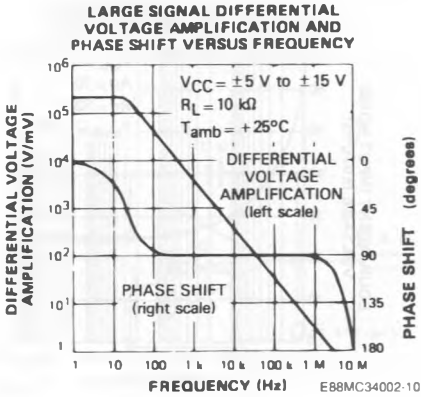

E88MC34002-10

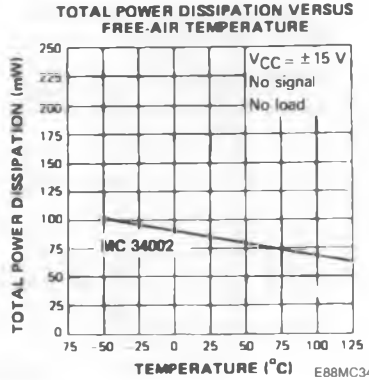

E88MC34002-11

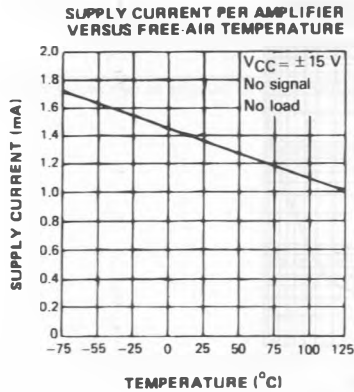

E88MC34002-12

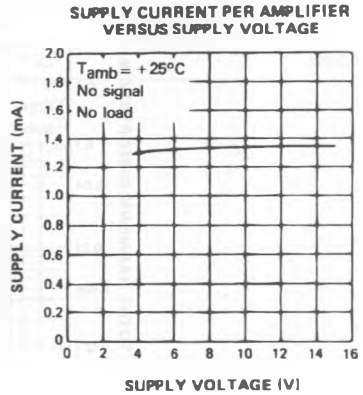

E88MC34002-13

COMMON MODE REJECTION RATIO
VERSUS FREE-AIR TEMPERATURE

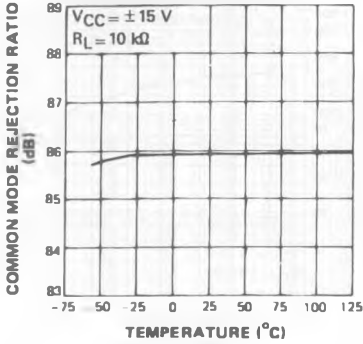

E88MC34002-14

VOLTAGE FOLLOWER LARGE
SIGNAL PULSE RESPONSE

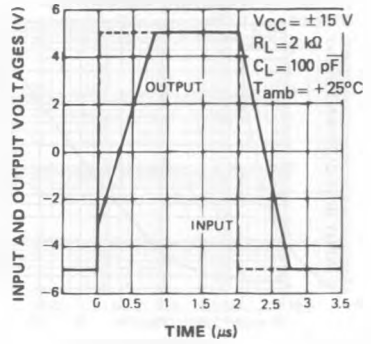

E88MC34002-15

OUTPUT VOLTAGE VERSUS TIME

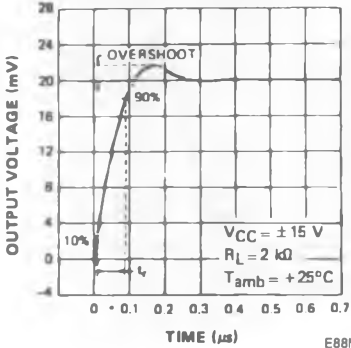

E88MC34002-16

EQUIVALENT INPUT NOISE VOL-
TAGE VERSUS FREQUENCY

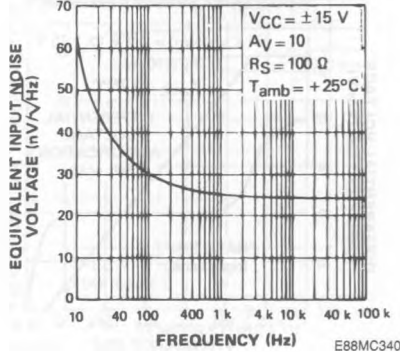

E88MC34002-17

TOTAL HARMONIC DISTORTION
VERSUS FREQUENCY

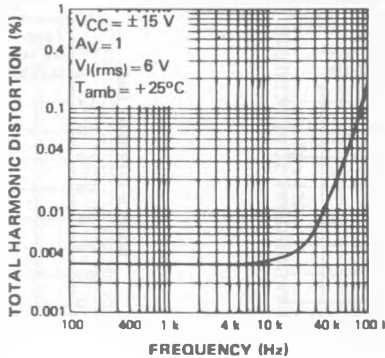

E88MC34002-18

PARAMETER MEASUREMENT INFORMATION

Figure 1 : Voltage Follower.

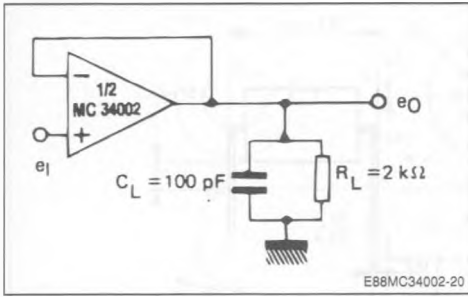
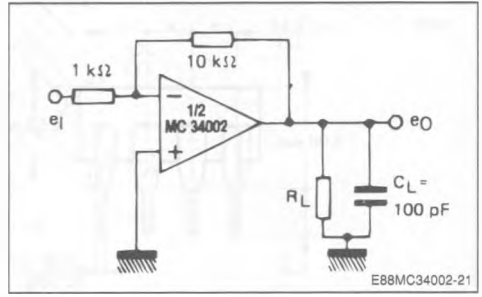
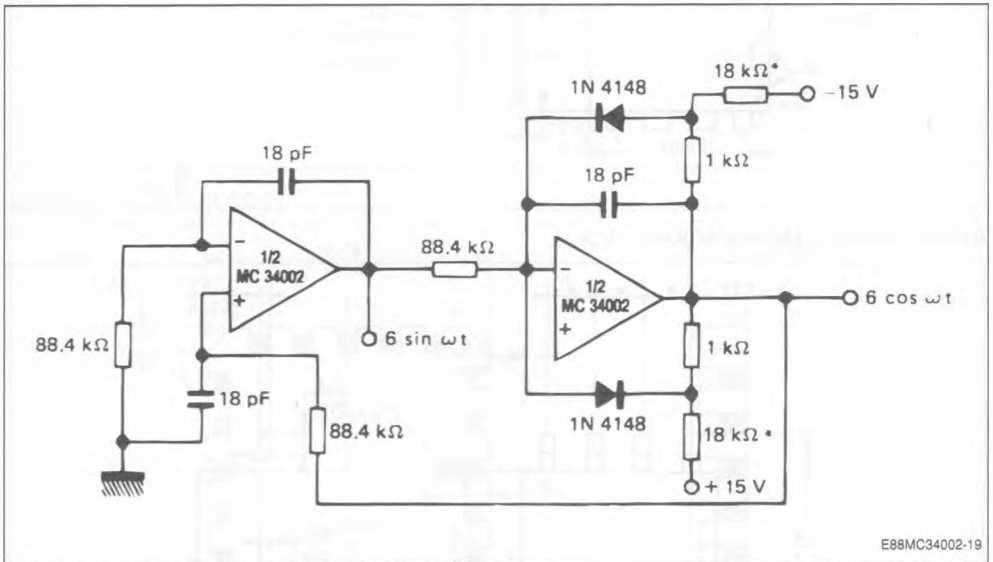

Figure 2 : Gain-of-10 Inverting Amplifier.



TYPICAL APPLICATION

QUADRATURE OSCILLATOR



* These resistor values may be adjusted for a symmetrical output.

PACKAGE MECHANICAL DATA

8 PINS - PLASTIC DIP

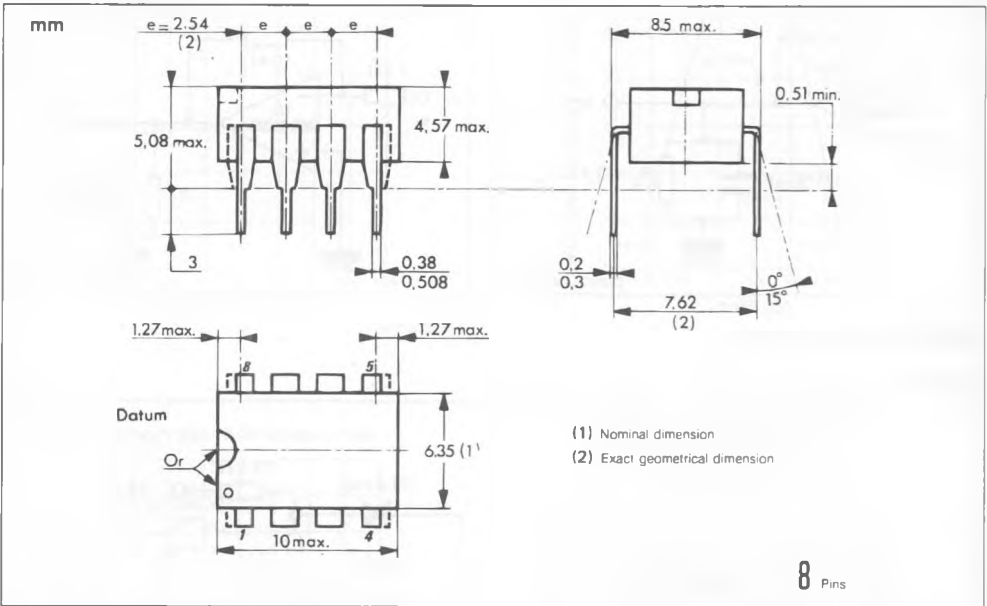

8 PINS - PLASTIC MICROPACKAGE (SO)

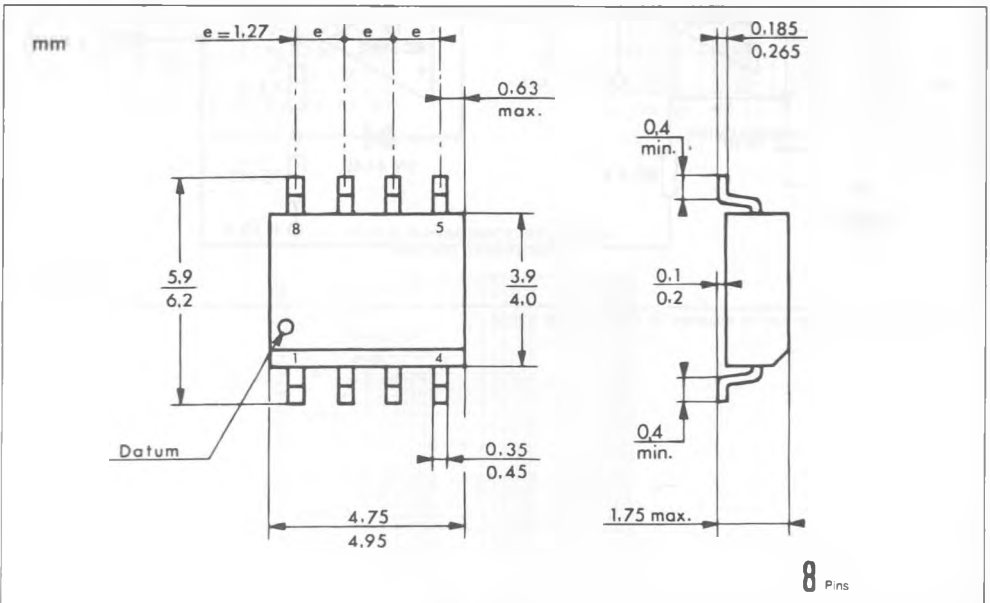

TO99 – METAL CAN

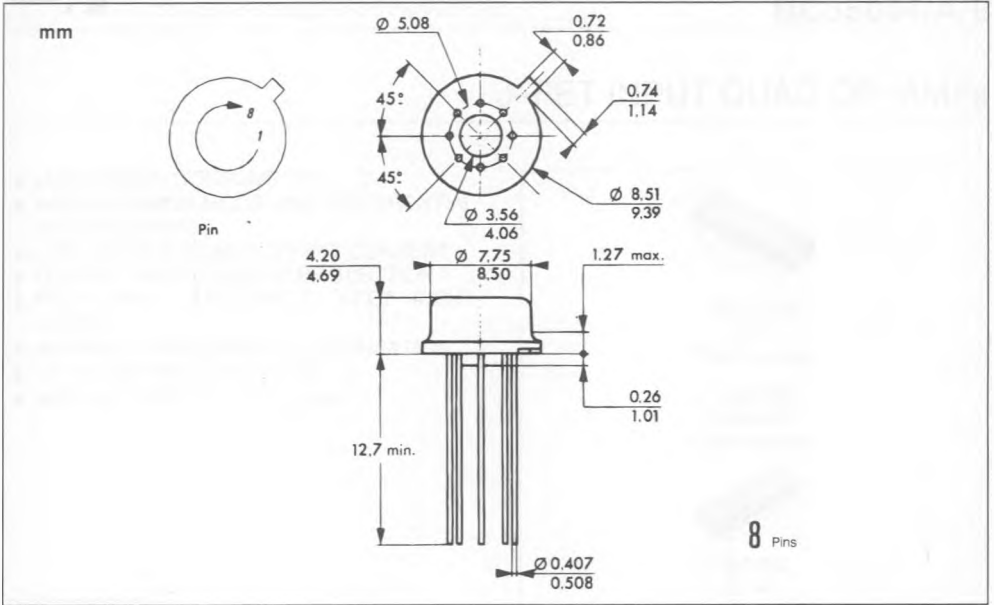

20 PINS – TRICECOP (LCC)

