

OCTAL COUNTER/DIVIDER

- **HIGH SPEED**
 $f_{MAX} = 44 \text{ MHz (TYP.) at } V_{CC} = 5\text{V}$
- **LOW POWER DISSIPATION**
 $I_{CC} = 4 \mu\text{A (MAX.) at } T_A = 25^\circ\text{C}$
- **HIGH NOISE IMMUNITY**
 $V_{NIH} = V_{NIL} = 28\% V_{CC} \text{ (MIN.)}$
- **OUTPUT DRIVE CAPABILITY**
 10 LSTTL LOADS
- **SYMMETRICAL OUTPUT IMPEDANCE**
 $|I_{OH}| = I_{OL} = 4 \text{ mA (MIN.)}$
- **BALANCED PROPAGATION DELAYS**
 $t_{PLH} = t_{PHL}$
- **WIDE OPERATING VOLTAGE RANGE**
 $V_{CC} \text{ (OPR)} = 2\text{V to } 6\text{V}$
- **PIN AND FUNCTION COMPATIBLE**
 WITH 4022B

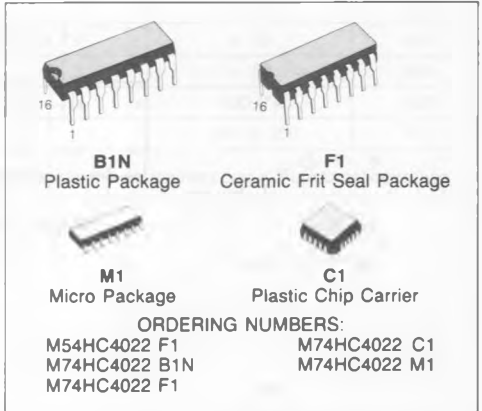





DESCRIPTION

The M54/74HC4022 is a high speed CMOS OCTAL COUNTER/DIVIDER fabricated in silicon gate C²MOS technology.

It has the same high speed performance of LSTTL combined with true CMOS low power consumption. It contains a 4-stage divide-by-8 Johnson counter with 8 decoded outputs (Q0-Q7) and a Carry-out bit. This counter is advanced on the positive edge of the clock signal when **CLOCK ENABLE** input is held low, or is advanced on the negative edge of clock enable signal when **CLOCK** input is held high, and the selected one of eight outputs goes high. Holding the **CLEAR** input high clears the counter to zero regardless of the other input conditions. All inputs are equipped with protection circuits against static discharge and transient excess voltage.

TRUTH TABLE

(X = DON'T CARE)

CLOCK	CE	CLEAR	DECODER OUTPUT(H)
X	X	H	Q0
L	X	L	NO CHANGE
X	H	L	NO CHANGE
	L	L	NO CHANGE + 1
	L	L	NO CHANGE
H		L	NO CHANGE
H		L	NO CHANGE + 1

PIN CONNECTIONS (top view)

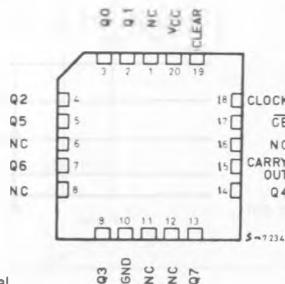
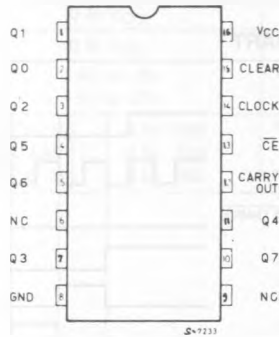

NC =
No Internal
Connection

LOGIC DIAGRAM

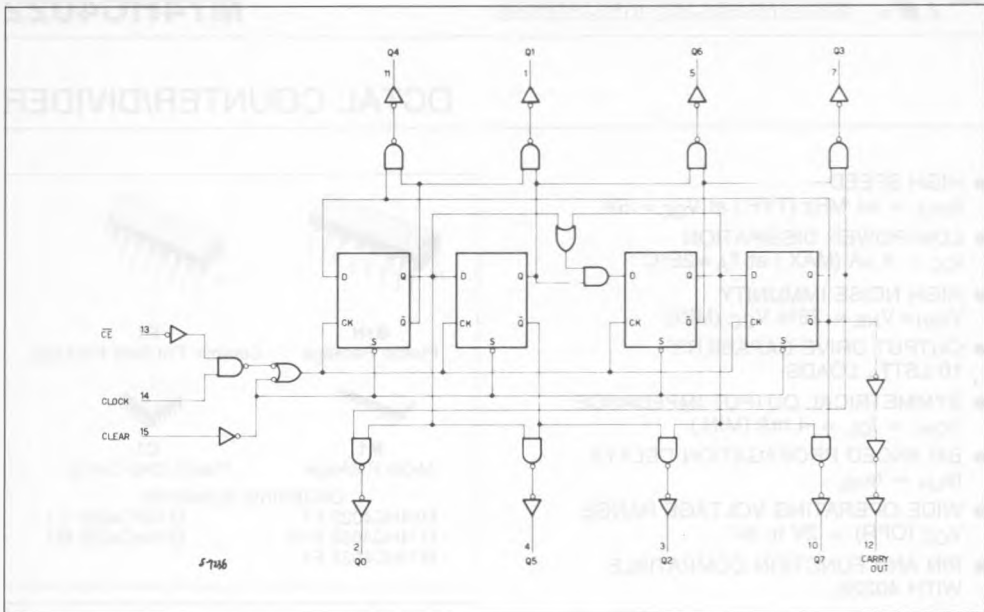

TIMING CHART

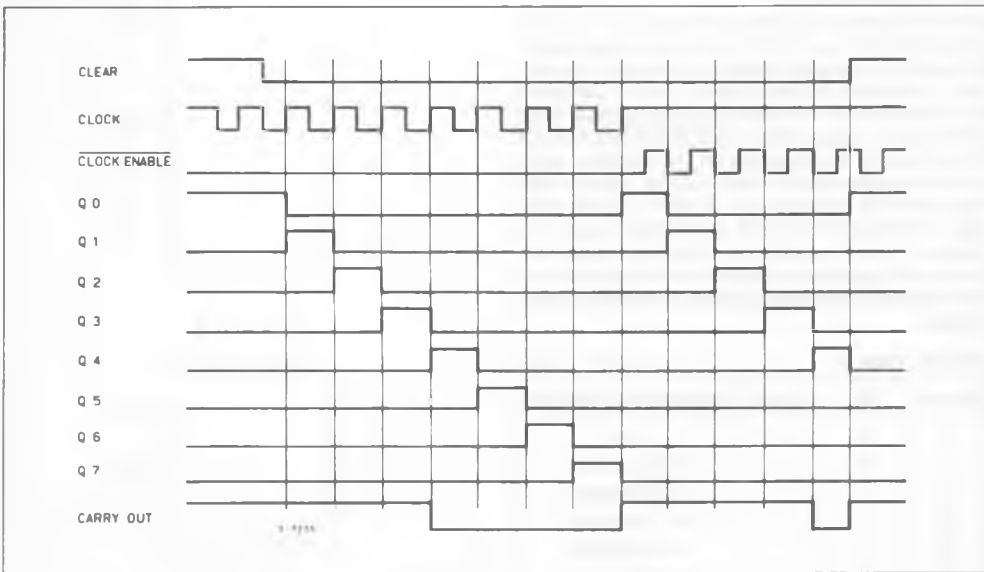

ABSOLUTE MAXIMUM RATINGS

Symbol	Parameter	Value	Unit
V_{CC}	Supply Voltage	-0.5 to 7	V
V_I	DC Input Voltage	-0.5 to $V_{CC} + 0.5$	V
V_O	DC Output Voltage	-0.5 to $V_{CC} + 0.5$	V
I_{IK}	DC Input Diode Current	± 20	mA
I_{OK}	DC Output Diode Current	± 20	mA
I_O	DC Output Source Sink Current Per Output Pin	± 25	mA
I_{CC} or I_{GND}	DC V_{CC} or Ground Current	± 50	mA
P_D	Power Dissipation	500 (*)	mW
T_{stg}	Storage Temperature	-65 to 150	$^{\circ}C$

Absolute Maximum Ratings are those values beyond which damage to the device may occur. Functional operation under these condition is not implied.

(*) 500 mW: $\cong 65^{\circ}C$ derate to 300 mW by 10 mW/ $^{\circ}C$: $65^{\circ}C$ to $85^{\circ}C$.

RECOMMENDED OPERATING CONDITIONS

Symbol	Parameter	Value	Unit
V_{CC}	Supply Voltage	2 to 6	V
V_I	Input Voltage	0 to V_{CC}	V
V_O	Output Voltage	0 to V_{CC}	V
T_A	Operating Temperature 74HC Series 54HC Series	-40 to 85 -55 to 125	$^{\circ}C$
t_r, t_f	Input Rise and Fall Time	$V_{CC} \begin{cases} 2 \text{ V} & 0 \text{ to } 1000 \\ 4.5 \text{ V} & 0 \text{ to } 500 \\ 6 \text{ V} & 0 \text{ to } 400 \end{cases}$	ns

INPUT AND OUTUT EQUIVALENT CIRCUIT

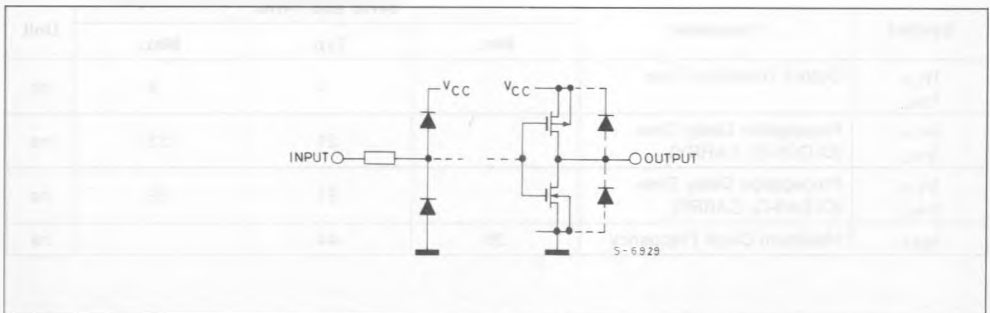

DC SPECIFICATIONS

Symbol	Parameter	V _{CC}	Test Condition	T _A = 25°C 54HC and 74HC			- 40 to 85°C 74HC		- 55 to 125°C 54HC		Unit	
				Min.	Typ.	Max.	Min.	Max.	Min.	Max.		
V _{IH}	High Level Input Voltage	2.0		1.5	—	—	1.5	—	1.5	—	V	
		4.5		3.15	—	—	3.15	—	3.15	—		
		6.0		4.2	—	—	4.2	—	4.2	—		
V _{IL}	Low Level Input Voltage	2.0		—	—	0.5	—	0.5	—	0.5	V	
		4.5		—	—	1.35	—	1.35	—	1.35		
		6.0		—	—	1.8	—	1.8	—	1.8		
V _{OH}	High Level Output Voltage	2.0	V _I	I _O	1.9	2.0	—	1.9	—	1.9	—	V
		4.5	V _{IH} or V _{IL}	- 20 μA	4.4	4.5	—	4.4	—	4.4	—	
		6.0			5.9	6.0	—	5.9	—	5.9	—	
		4.5	V _{IH} or V _{IL}	- 4.0 mA	4.18	4.31	—	4.13	—	4.10	—	
6.0	- 5.2 mA	5.68			5.8	—	5.63	—	5.60	—		
V _{OL}	Low Level Output Voltage	2.0	V _{IH} or V _{IL}	20 μA	—	0.0	0.1	—	0.1	—	0.1	V
		4.5			—	0.0	0.1	—	0.1	—	0.1	
		6.0			—	0.0	0.1	—	0.1	—	0.1	
		4.5			V _{IH} or V _{IL}	4.0 mA	—	0.17	0.26	—	0.33	
6.0	5.2 mA	—	0.18	0.26			—	0.33	—	0.40		
I _I	Input Leakage Current	6.0	V _I = V _{CC} or GND		—	—	±0.1	—	±1.0	—	±1.0	μA
I _{CC}	Quiescent Supply Current	6.0	V _I = V _{CC} or GND		—	—	4	—	40	—	80	μA

AC ELECTRICAL CHARACTERISTICS (V_{CC} = 5V, T_A = 25°C, C_L = 15pF, Input t_r = t_f = 6ns)

Symbol	Parameter	54HC and 74HC			Unit
		Min.	Typ.	Max.	
t _{TLH} t _{THL}	Output Transition Time		4	8	ns
t _{PLH} t _{PHL}	Propagation Delay Time (CLOCK-Q, CARRY)		21	33	ns
t _{PLH} t _{PHL}	Propagation Delay Time (CLEAR-Q, CARRY)		21	33	ns
f _{MAX}	Maximum Clock Frequency	28	44		ns

AC ELECTRICAL CHARACTERISTICS ($C_L = 50\text{pF}$, Input $t_r = t_f = 6\text{ns}$)

Symbol	Parameter	V_{CC}	Test Condition	$T_A = 25^\circ\text{C}$ 54HC and 74HC			-40 to 85°C 74HC		-55 to 125°C 54HC		Unit
				Min.	Typ.	Max.	Min.	Max.	Min.	Max.	
t_{TLH} t_{THL}	Output Transition Time	2.0		—	30	75	—	95	—	110	ns
		4.5		—	8	15	—	19	—	22	
		6.0		—	7	13	—	16	—	19	
t_{PLH} t_{PHL}	Propagation Delay Time (CLOCK-Q, CARRY)	2.0		—	100	195	—	245	—	295	ns
		4.5		—	25	39	—	49	—	59	
		6.0		—	21	33	—	42	—	50	
t_{PLH} t_{PHL}	Propagation Delay Time (CLEAR-Q, CARRY)	2.0		—	100	195	—	245	—	295	ns
		4.5		—	25	39	—	49	—	59	
		6.0		—	21	33	—	42	—	50	
f_{MAX}	Maximum Clock Frequency	2.0		5	10	—	4.0	—	3.4	—	MHz
		4.5		25	40	—	20	—	17	—	
		6.0		29	47	—	24	—	20	—	
$t_{W(H)}$ $t_{W(L)}$	Minimum Pulse Width (CLOCK)	2.0		—	30	75	—	95	—	110	ns
		4.5		—	8	15	—	19	—	22	
		6.0		—	7	13	—	16	—	19	
$t_{W(H)}$	Minimum Pulse Width (CLEAR)	2.0		—	35	75	—	95	—	110	ns
		4.5		—	9	15	—	19	—	22	
		6.0		—	8	13	—	16	—	19	
t_s	Minimum Set-up Time	2.0		—	—	0	—	0	—	0	ns
		4.5		—	—	0	—	0	—	0	
		6.0		—	—	0	—	0	—	0	
t_h	Minimum Hold Time	2.0		—	35	75	—	95	—	110	ns
		4.5		—	9	15	—	19	—	22	
		6.0		—	8	13	—	16	—	19	
t_{REM}	Minimum Removal Time	2.0		—	30	75	—	95	—	110	ns
		4.5		—	8	15	—	19	—	22	
		6.0		—	7	13	—	16	—	19	
C_{IN}	Input Capacitance			—	5	10	—	10	—	10	pF
$C_{PD} (*)$	Power Dissipation Capacitance			—	52	—	—	—	—	—	pF

Note (*) C_{PD} is defined as the value of the IC's internal equivalent capacitance which is calculated from the operating current consumption without load. (Refer to Test Circuit)

Average operating current can be obtained by the following equation

$$I_{CC(oper)} = C_{PD} \cdot V_{CC} \cdot f_{IN} + I_{CC}$$

SWITCHING CHARACTERISTICS TEST WAVEFORM

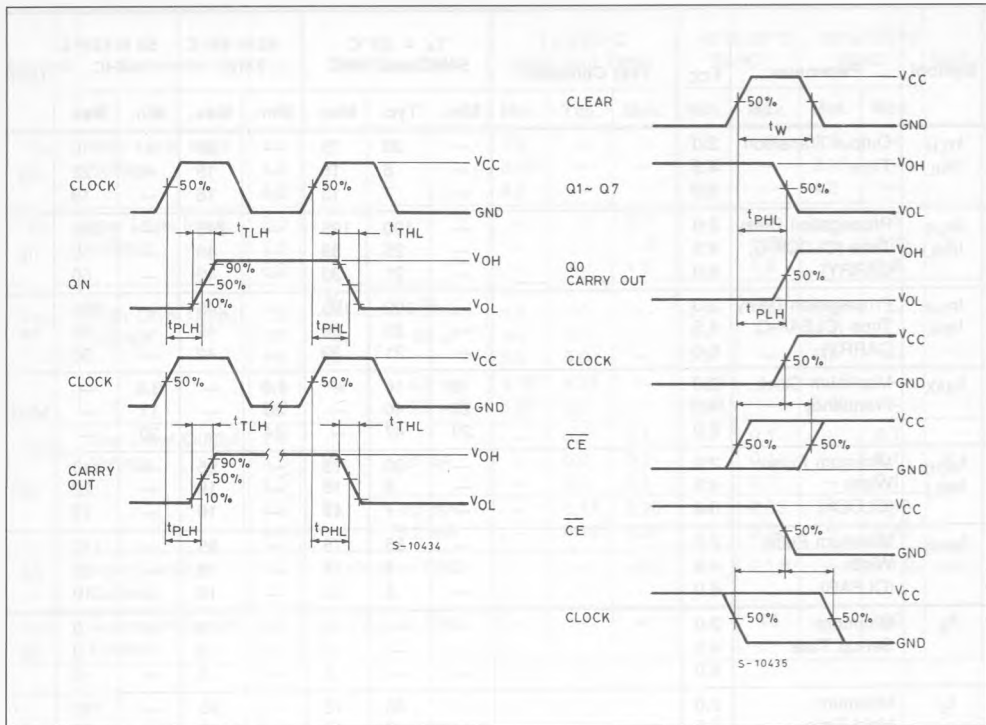

TEST CIRCUIT I_{CC} (Opr.)

