



## LA4460N, 4461N

### 12W AF Power Amplifier for Car Radio, Car Stereo

#### Features

- High gain of 51dB typ. and high power output of 12W typ.
- Possible to delete output and bootstrap capacitors, this encourages cost and space reductions due to external parts reduction.
- Reduced external components (8 pieces recommended, 6 pieces minimum).
- Almost no pop noises heard during power on or off operation.
- Soft tonal quality in saturated power output.
- Low distortion over low to high ranges of the audio frequencies.
- Low residual noises ( $R_g=0$ ).
- Good operation conditions because of SIP (single ended pins) package having been employed for the LA4460N.
- All pin terminal layouts of the LA4461N are reversed for easy stereo PC board pattern arrangement.
- Two ground terminals for pre-amplifier and power amplifier are provided for easy PC board pattern arrangement and for stabilizing distortion characteristics depending on signal source impedance.
- Voltage gain is fixed at 51dB, however, lowering the gain is possible by adding a resistor.
- IC is not damaged, if it is connected reversely.
- Audio muting functions (AC mute & DC mute) are equipped.
- Several protection circuits are installed, including :
  - a. Thermal protection circuit.
  - b. Overvoltage & surge voltage protection circuit.
  - c. Load short-circuit current limiting protection circuit.
  - d. Output pins DC short-circuit protection circuit.  
(grounding protection between OUT & GND, and speaker protection provided.)

#### Package Dimensions

unit:mm

3024A-SIP10H

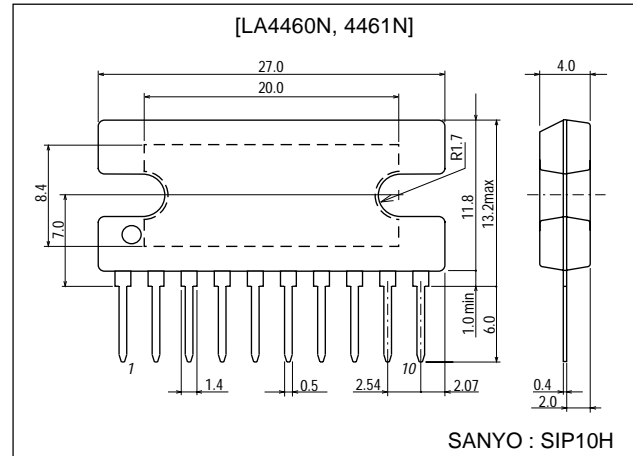

■ Any and all SANYO products described or contained herein do not have specifications that can handle applications that require extremely high levels of reliability, such as life-support systems, aircraft's control systems, or other applications whose failure can be reasonably expected to result in serious physical and/or material damage. Consult with your SANYO representative nearest you before using any SANYO products described or contained herein in such applications.

■ SANYO assumes no responsibility for equipment failures that result from using products at values that exceed, even momentarily, rated values (such as maximum ratings, operating condition ranges, or other parameters) listed in products specifications of any and all SANYO products described or contained herein.

**SANYO Electric Co., Ltd. Semiconductor Company**

TOKYO OFFICE Tokyo Bldg., 1-10, 1 Chome, Ueno, Taito-ku, TOKYO, 110-8534 JAPAN

21500TN (KT)/90196RM/D187KI, TS No.2660-1/12

# LA4460N, 4461N

## Specifications

### Absolute Maximum Ratings at $T_a = 25^\circ\text{C}$

Parameter	Symbol	Conditions	Ratings	Unit
Maximum supply voltage	$V_{CC \text{ max1}}$	Quiescent (30s)	25	V
	$V_{CC \text{ max2}}$	with signal	18	V
Supply current	$I_{10\text{peak}}$	Instantaneous value duty $\leq$ 5%, pulse width $\leq$ 1ms flow-in only	4.5	A
Output current	$I_7, I_9 \text{ peak}$	Instantaneous value duty $\leq$ 5%, pulse width $\leq$ 1ms	4.5	A
Surge supply voltage	$V_{\text{surge}}$	$t \leq 0.2\text{s}$	50	V
Allowable power dissipation	$P_d \text{ max}$	$T_c = 75^\circ\text{C}$ , See $P_d \text{ max} - T_a$ graph.	25	W
Package thermal resistance	$\theta_{j-c}$		3	$^\circ\text{C/W}$
Operating temperature	$T_{\text{opr}}$		-20 to +75	$^\circ\text{C}$
Storage temperature	$T_{\text{stg}}$		-40 to +150	$^\circ\text{C}$

### Recommended Operating Conditions at $T_a = 25^\circ\text{C}$

Parameter	Symbol	Conditions	Ratings	Unit
Recommended supply voltage	$V_{CC}$		13.2	V
Load resistance	$R_L$		4 to 8	$\Omega$

### Operating Characteristics at $T_a = 25^\circ\text{C}$ , $V_{CC} = 13.2\text{V}$ , $R_L = 4\Omega$ , $f = 1\text{kHz}$ , $R_g = 600\Omega$ , with $100 \times 100 \times 1.5\text{mm}^3$

Al heat sink, See specified Test Circuit

Parameter	Symbol	Conditions	Ratings			Unit
			min	typ	max	
Quiescent current	$I_{CCO}$			65	120	mA
Voltage gain	VG	closed loop, at specified recommended circuit.	49	51	53	dB
Output power	$P_O$	THD=10%	10	12		W
Total harmonic distortion	THD	$P_O = 1\text{W}$		0.1	1.0	%
Input resistance	$r_i$		21	30		$k\Omega$
Output noise voltage	$V_{NO1}$	$R_g = 0$ , $f = 20\text{Hz}$ to $20\text{kHz}$ , band-pass filter		0.4	1.0	mV
	$V_{NO2}$	$R_g = 10k\Omega$ , $f = 20\text{Hz}$ to $20\text{kHz}$ , band-pass filter		0.6	2.0	mV
Output offset voltage	$V_{\text{off}}$		-300		+300	mV
Muting attenuation (AC)	ATT	$V_O = 0\text{dBm}$ , $V_M = 9\text{V}$		38		dB

(Note) : For DC muting,  $ATT = \infty$

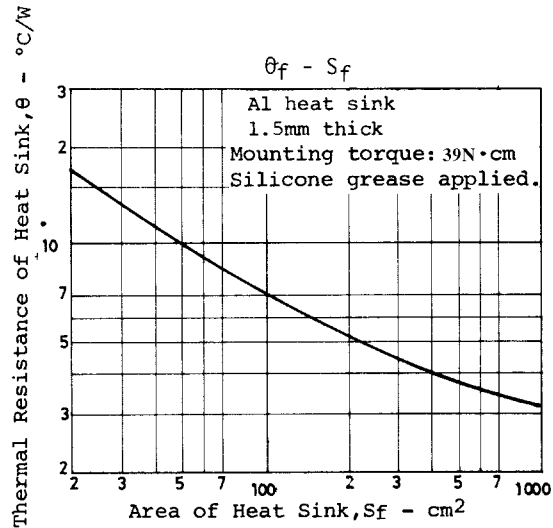
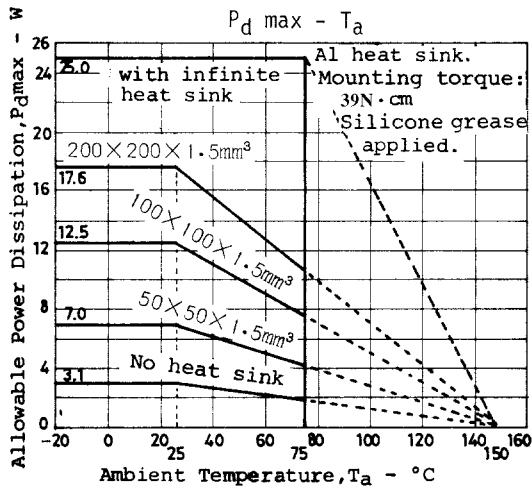

# LA4460N, 4461N

## Equivalent Circuit Block Diagram

( ): LA4461N

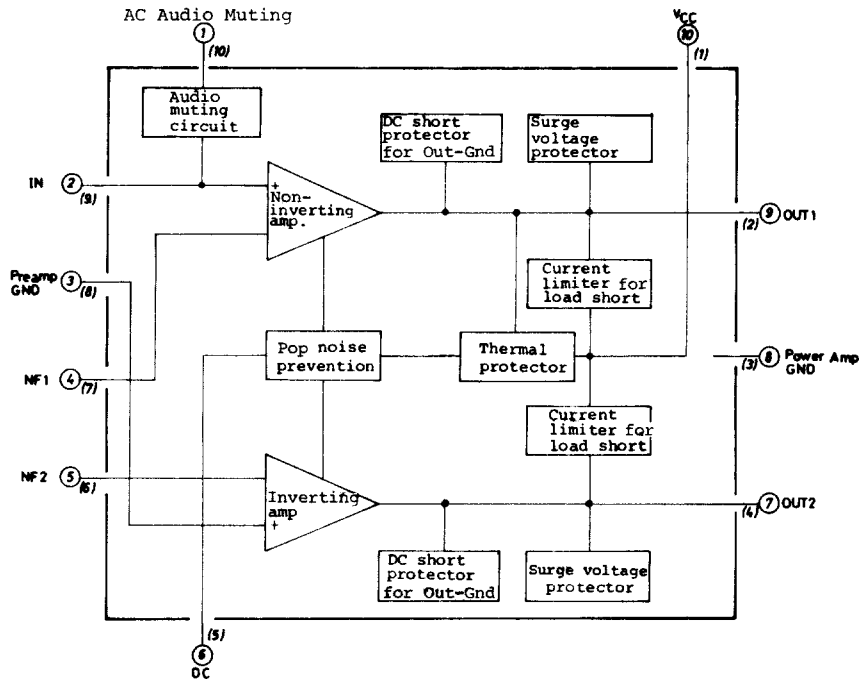

## Sample Application Circuit 1 : Recommended Circuit

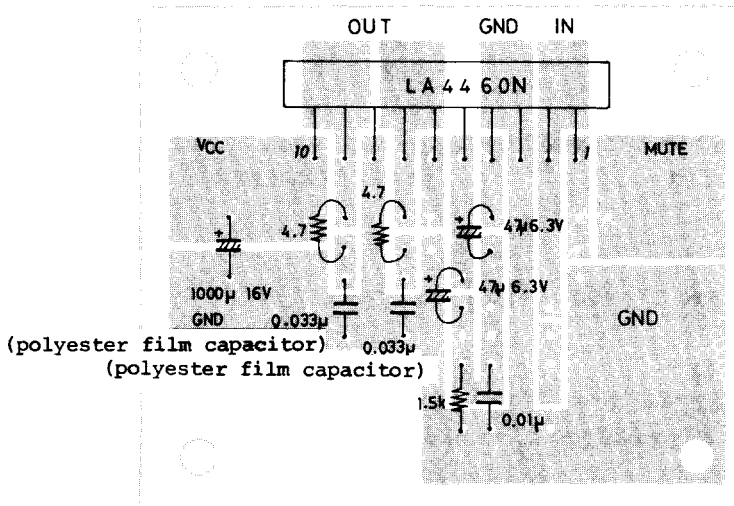
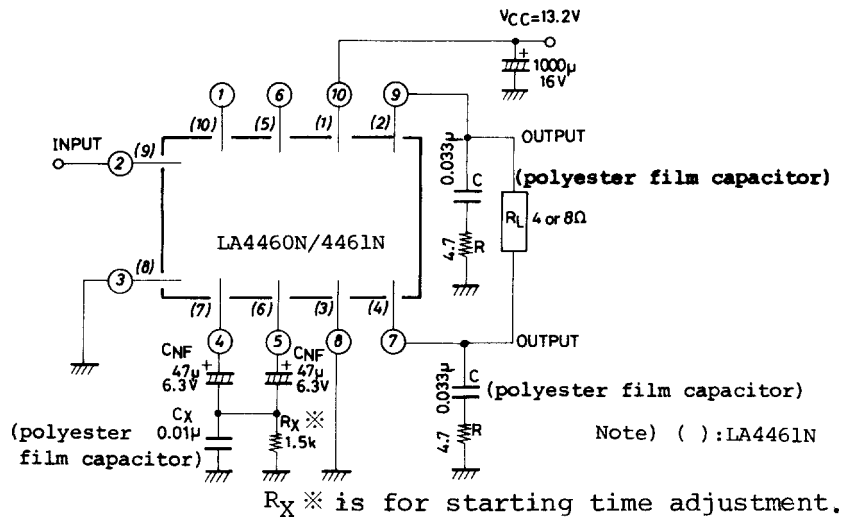

Sample Printed Circuit Pattern of LA4460N (Cu-foiled side) 40 x 50mm<sup>2</sup>

# LA4460N, 4461N

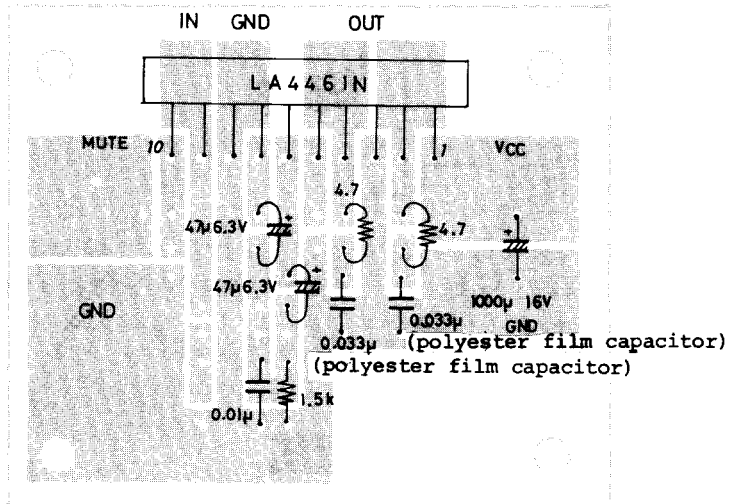

Sample Printed Circuit Pattern of LA4461N (Cu-foiled side) 40 x 50mm<sup>2</sup>

## Sample Application Circuit 2 : An Example with Minimum Parts

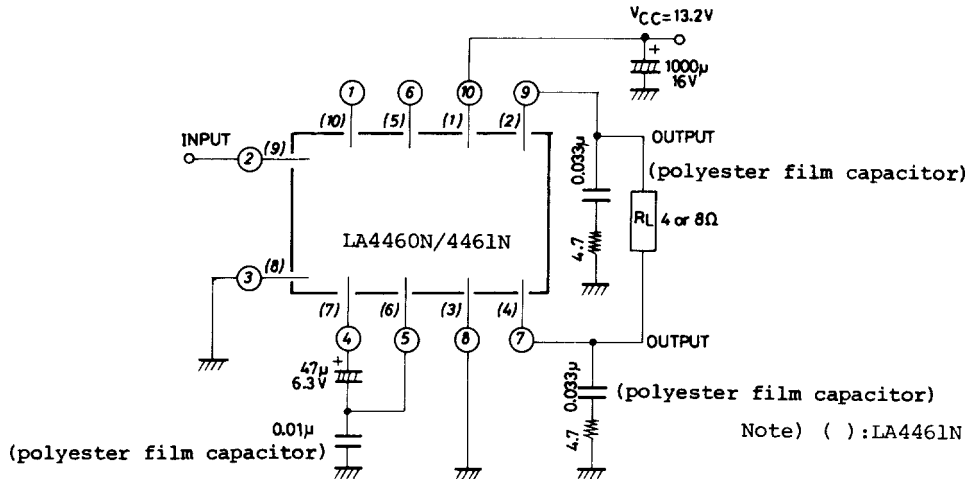

## Functional Description on the External Parts

Recommended number of the external parts for the LA4460N/4461N is 8 as shown in the Sample Application Circuit 1. Namely they are :

- Feedback capacitors                      2 pieces        4.7µF/6.3V×2
- Starting time adjustmant resistor      1 pieace        1.5kΩ
- Oscillation compensation capacitor    1 piece        0.01µF
- Oscillation compensation C · R        4 pieces        0.033µF×2, 4.7Ω×2

### a) Feedback capacitor C<sub>NF</sub>

This relates to a low range cutoff frequency  $f_L$ , and  $f_L$  lowers with increasing value of the 'C<sub>NF</sub> and increases with decreasing C<sub>NF</sub>.

### b) Oscillation compensation capacitor C<sub>X</sub>

Signals are applied from the non-inverted NF terminal to the inverted NF terminal through the two C<sub>NF</sub> capacitors. It is recommended to connect the oscillation compensation capacitor C<sub>X</sub>=0.01µF between the floating junction of the capacitors (minus side of C<sub>NF</sub>) and GND. As a rule a polyester film capacitor is recommended, but a ceramic type may be used if a PC board shows good circuit stability.

c) Starting time adjustment resistor  $R_X$

The purpose of the  $R_X$  is to adjust the starting time  $t_s$ , and a resistor of  $1.5k\Omega$  is used. In this case, a rising DC locus as shown below will be obtained at the output terminals.

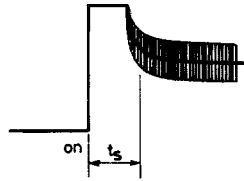

The circuit has been set to provide signals about  $0.4\mu s$ . after the power is turned on. Though the  $t_s$  will increase with decreasing  $R_X$ , the total output across the load will be decreased, since the signal flowing to the non-inverted side will flow into the ground through the  $R_X$ . Contrarily, increasing the  $R_X$  to  $R_X=\infty$  as shown in the Sample Application Circuit 2, the  $t_s$  reduces to zero s., and the rising locus as shown below will be obtained.



d) Oscillation compensation CR across the load

To prevent parasitic oscillation, it is recommended to connect  $0.033\mu F$  plus  $4.7\Omega$  between each channel output terminal and GND. (As a rule the capacitor should be a polyester film capacitor.) This measure against the oscillation may be replaced with the methods as shown below, depending upon the stability of PC boards used.

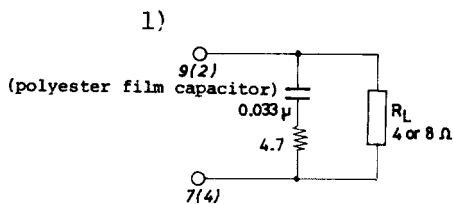

Note :

- Check for oscillation at low temperatures.
- Check for oscillation on stereo PC boards.
- Do not use shielded wires for output cords.

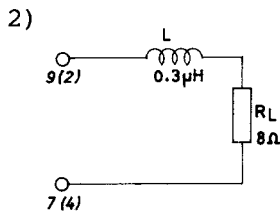

Note :

- Check for oscillation at low temperatures.
- Use  $8\Omega$  load resistor.
- Do not use shielded wires for output cords.
- L should be higher than  $0.3\mu H$ .

(Removal of oscillation compensation CR)

Coil used

Air core

Inner diameter :  $8\phi$

Number of turns : 6 turns

Wire size : UEW 1.5

Winding method : Solenoid ( $0.3\mu H$ )

Above examples can be applied to the Sample Application Circuits 1, 2.

**Features of IC System and Roles of the Remaining Pin Terminals**

- Since a zero-bias design is introduced into the input circuit to keep the input potential at about zero by employing PNP in the input circuit, an input coupling capacitor can be removed for direct connection. However, when noises caused by a DC current flowing to a volume control circuit or the input circuit causes problems, connect a capacitor in series with the input circuit.
- To prevent damage or deterioration of the IC due to the load short-circuited, a load short-circuit current limiting type protection circuit has been provided. However, when making the load short-circuit test, always mount the IC on the specified heat sink.
- A circuit which prevents pop noise caused by the power on-off operation is also provided, thereby reducing the offset voltage and protecting speaker systems against damage.

Continued on next page.

Continued from preceding page.

- Soft clipping characteristics are accomplished by lowering the open loop voltage gain and reducing the amount of feedback to reduce undesired radiation to radio frequency circuits and to increase the circuit stability. The distortion deterioration resulted from the decreased amount of feedback will be avoided by using a unique distortion reduction circuit, thus 0.1% typ. will be assured.
- A capacitor for oscillation compensation is included inside the IC as a method of reducing external parts. The capacitance is 30pF and this determines the cutoff frequency  $f_H$  (-3dB point) of the high range ( $f_H \approx 30\text{kHz}$ ).
- To reduce variations of the voltage gain, a feedback resistor  $R_{NF}$  is also built-in, and the voltage gain is fixed to 51dB.

$$R_{NF}=53\Omega, R_f=20\text{k}\Omega$$

when  $R_{NF}'=0$

$$VG=20\log \frac{R_f}{R_{NF}} \text{ (dB)}$$

when  $R_{NF}'$  is used

$$VG=20\log \frac{R_f}{R_{NF} + \frac{R_{NF}'}{2}} \text{ (dB)}$$

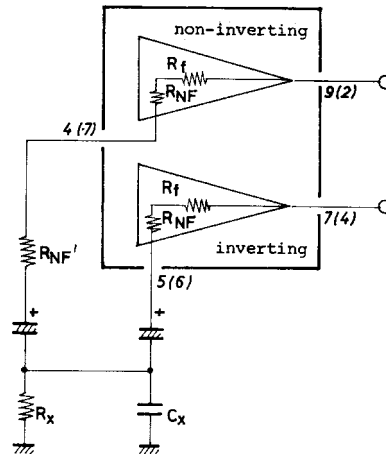

However the voltage gain will be decreased by adding a resistor  $R_{NF}'$ , where the  $R_{NF}'$  is the resistor to be connected to the pin 4. (In the Sample Application Circuit 2, the gain adjustment will be made with the resistor connected to either pin 4 or 5.)

- Two ground pin terminals are provided, one for the preamplifier and the other for the power amplifier. Accordingly, stability of the IC is increased, especially, distortion deterioration phenomenon caused by increased signal source impedance  $R_g$  is improved and a flat response will be obtained.
- An overvoltage protector circuit is included to protect the IC from damage when a surge voltage is applied to the power line. The overvoltage is set at 25V, however, the circuit can resist 50V for giant pulse surge of 200ms.
- For OCL connections, a DC short-circuit protection circuit is required. Therefore a grounding protection circuit which endures against the OUTPUT-GND short-circuit is provided. Since consideration is given to the offset caused by short-circuit or releasing the short-circuit both the speaker and the IC can be protected.
- When adding an audio muting circuit in each application circuit, refer to the illustration below.

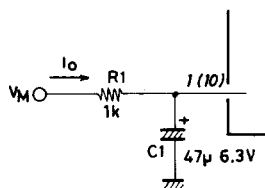

$6V \leq V_M \leq V_{CC}$   
 Recommended  $V_M=9V$   
 ATT=38dB ( $R_g=600\Omega$ )

Flow-in current  $I_O$  is calculated as shown below.

$$I_O = \frac{V_M - V_{BE}}{R_1}$$

To increase muting attenuation, connect a resistor of 5.6k $\Omega$  in series with the input circuit, then the attenuation will be increased to 55dB. It should be noted that adding an input capacitor will increase pop noise when the AC muting is operated. Pop noise can be reduced by increasing the value of  $R_1$  and  $C_1$ .

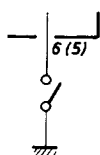

Common switch

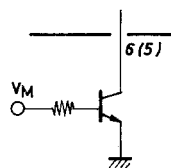

Transistorized switch

# LA4460N, 4461N

## Pin Voltage (unit : V)

LA4460N	1	2	3	4	5	6	7	8	9	10
LA4461N	10	9	8	7	6	5	4	3	2	1
Function	AC Audio Muting	INPUT	Pre GND	NON INV NF	INV OUT	DC Audio Muting	INV OUT	Power GND	NON INV OUT	V <sub>CC</sub>
Quiescent pin voltage	0	0.06	0	2.8	2.8	5.6	6.6	0	6.6	13.2

Much data on general characteristics are given for the Sample Application 1, but these data can be also applied to the Sample Application 2 because of no characteristic changed. However, the data on “Pop noise at power turned on”, “Starting time  $t_s$ ” and “DC muting” are shown for only the Sample Application 1. For the same characteristics to be applied to the Sample Application 2, refer to 1-C on page 4.

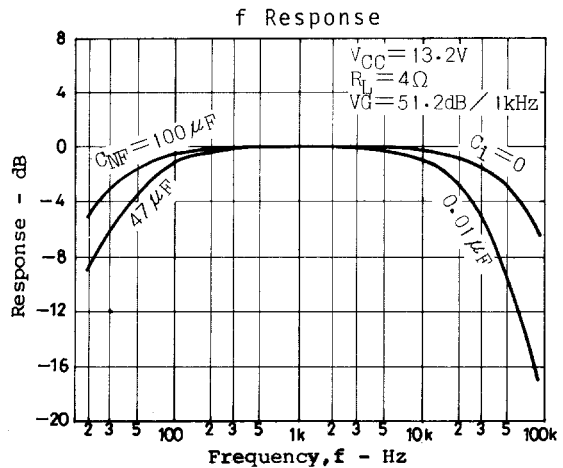
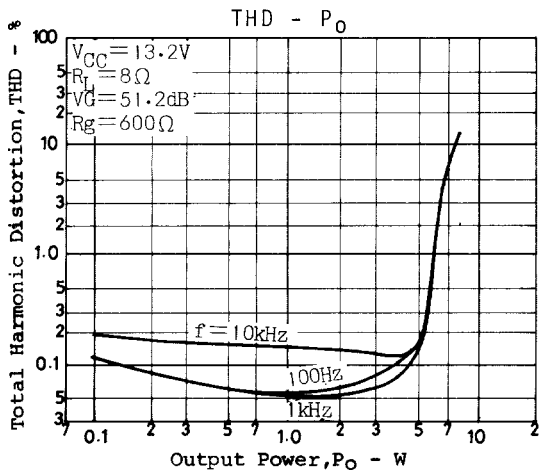
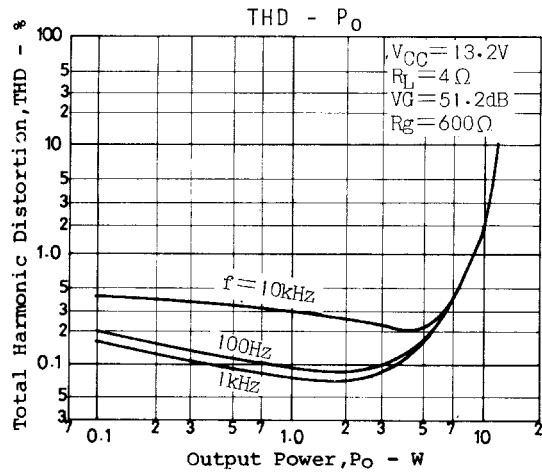
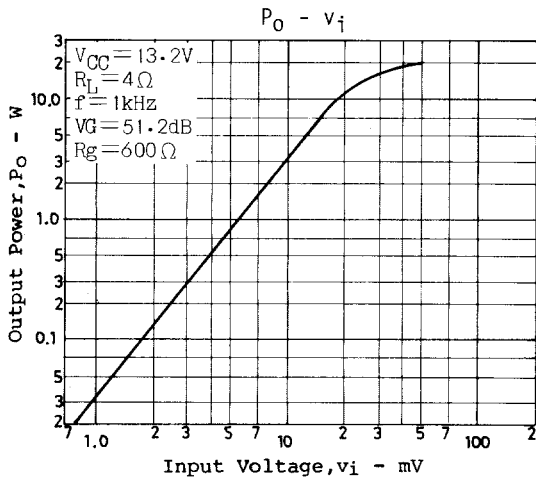
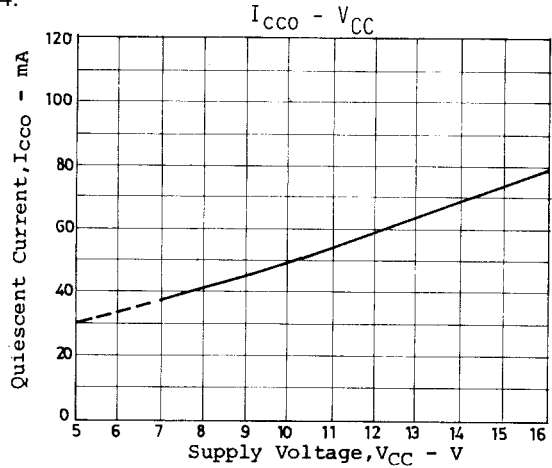

# LA4460N, 4461N

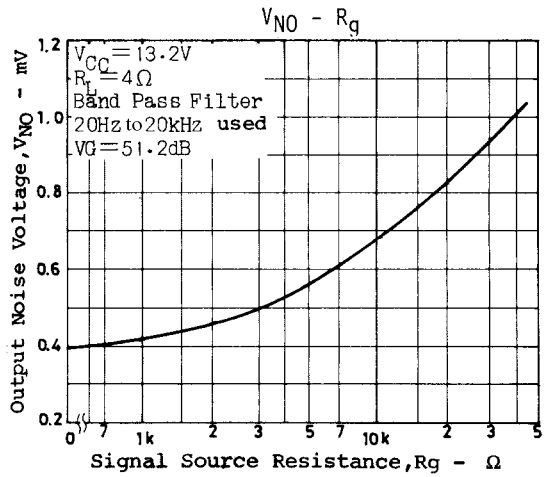
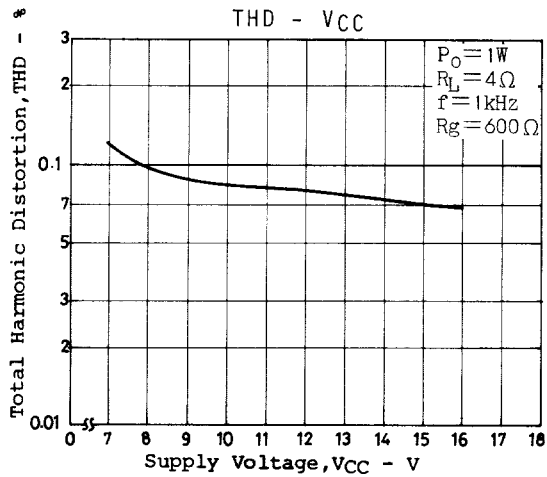
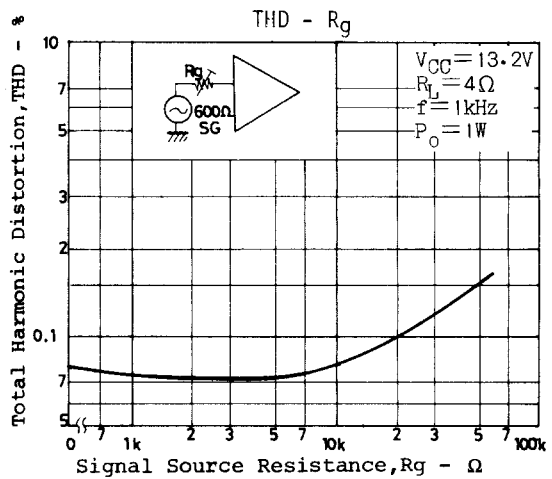
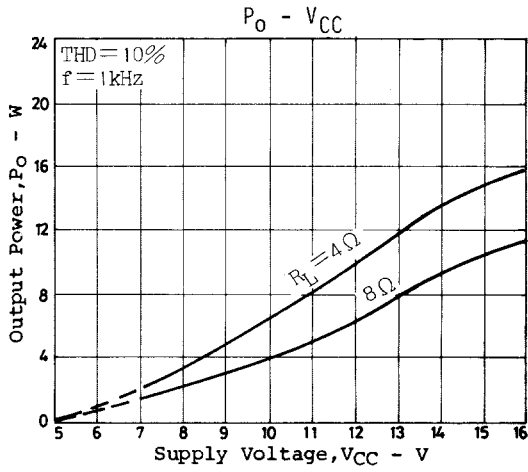
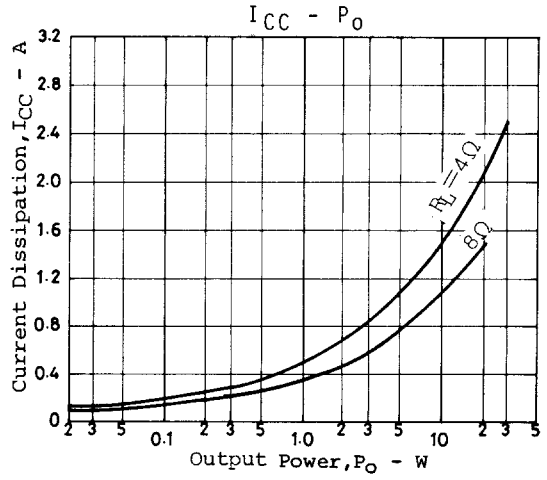
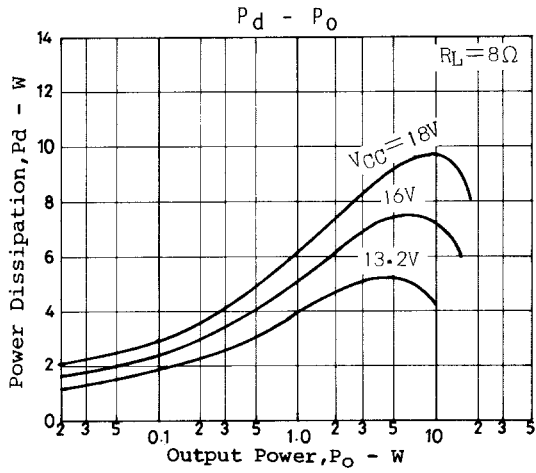
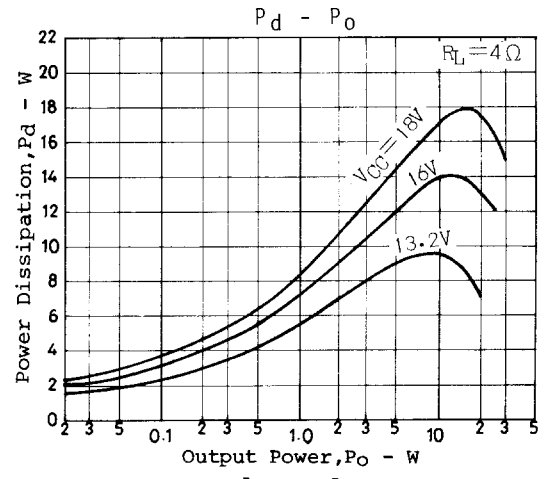
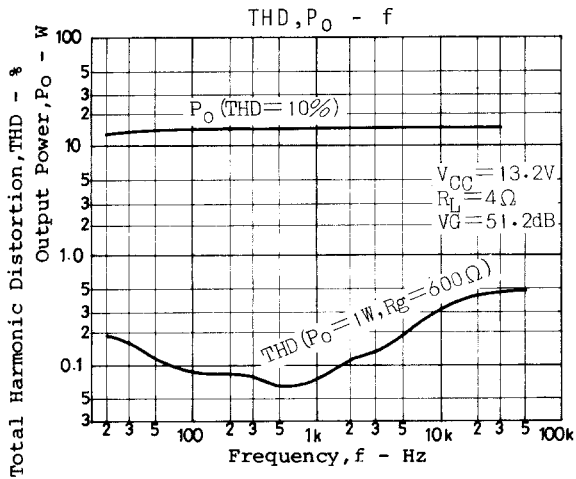



# LA4460N, 4461N

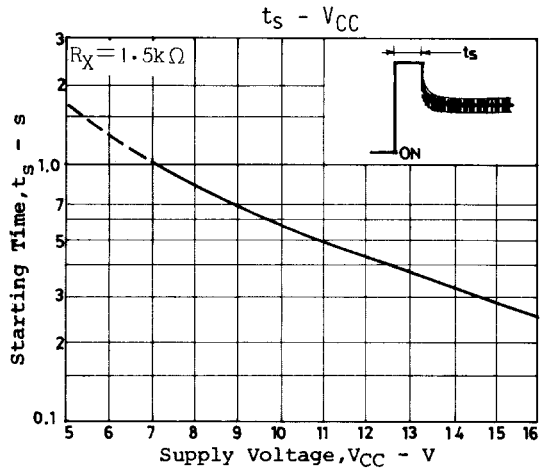
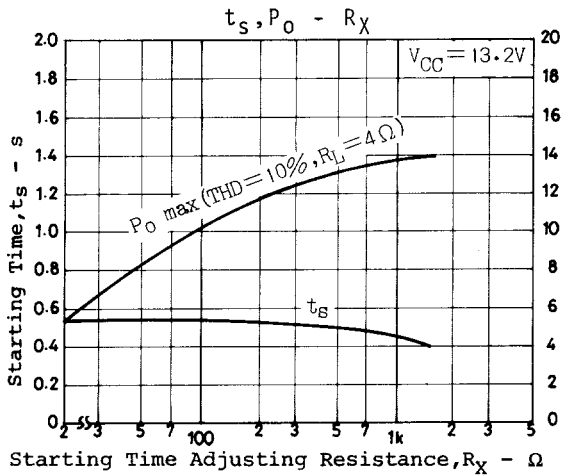
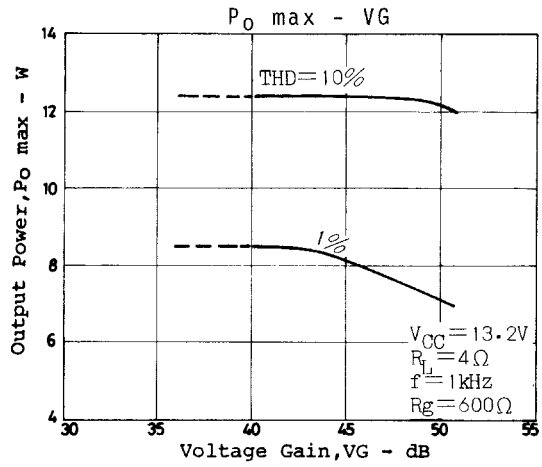
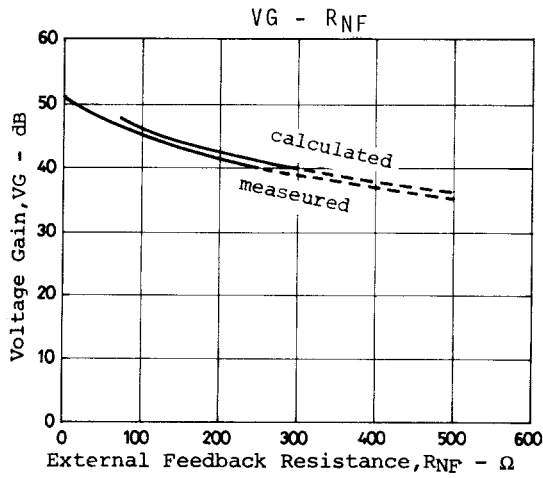
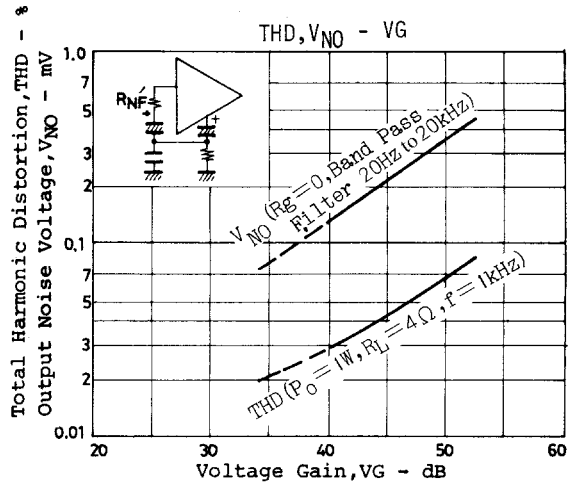
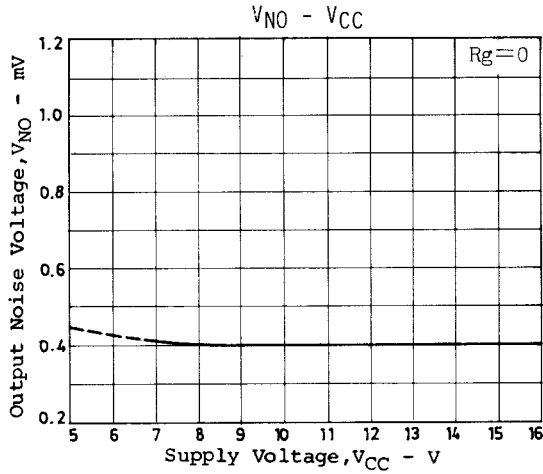

ATT - V<sub>M</sub> Test Circuit

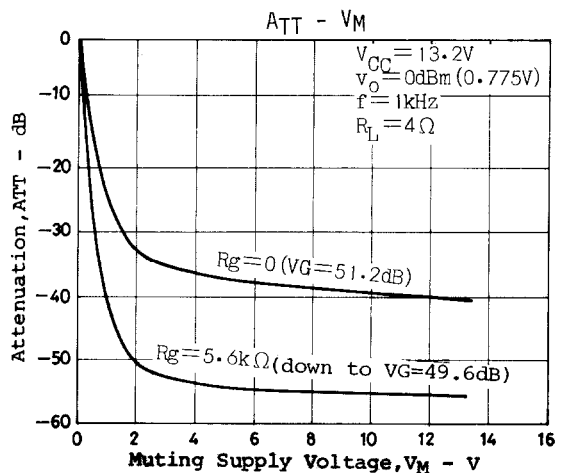
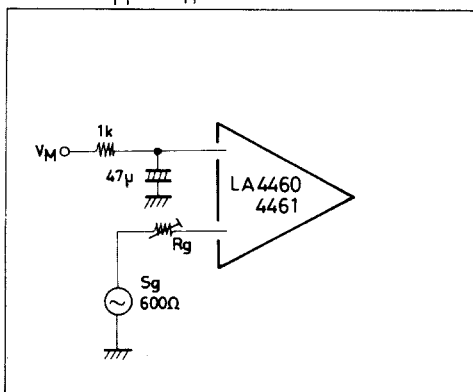

# LA4460N, 4461N

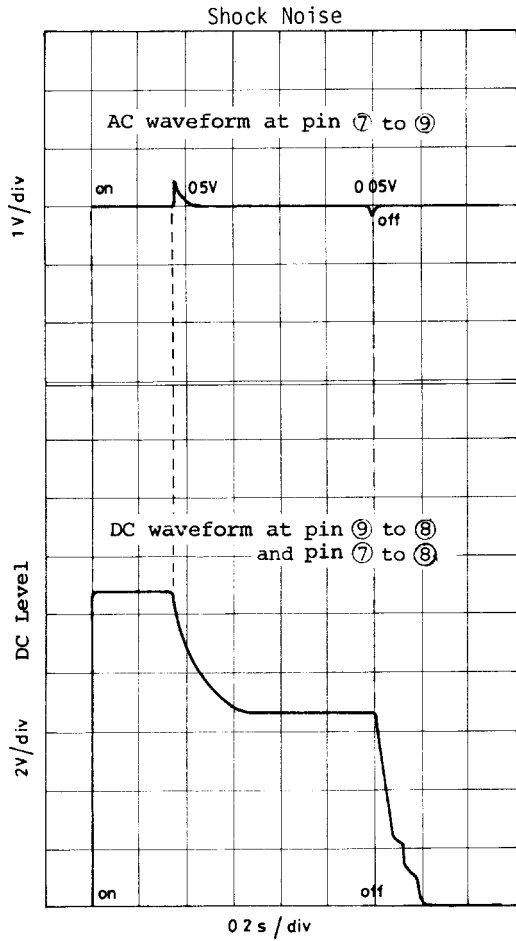

AC, DC Audio Muting Test Circuit

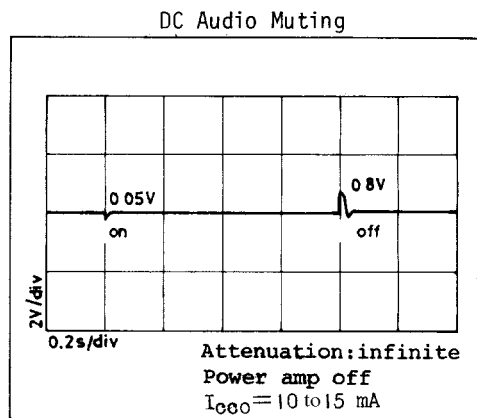
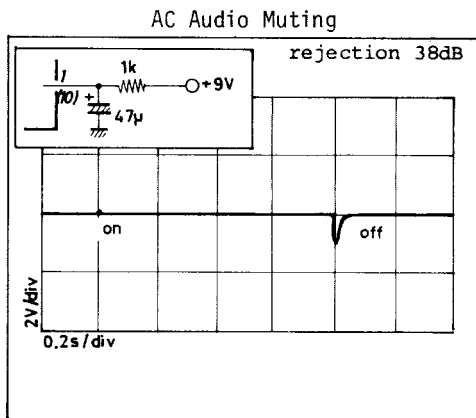
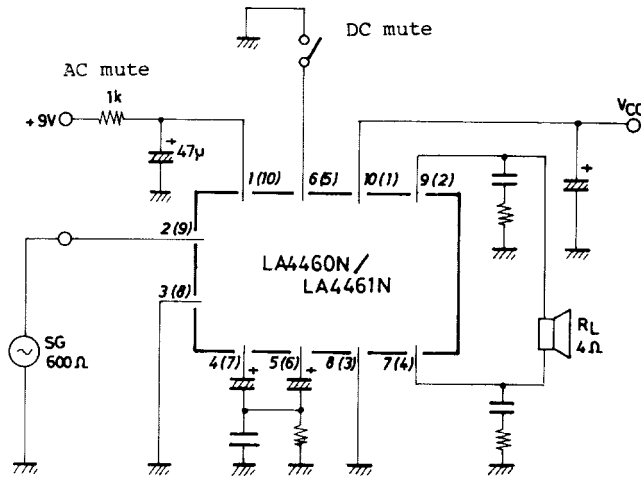

# LA4460N, 4461N

## Sample Application Circuit 3 :

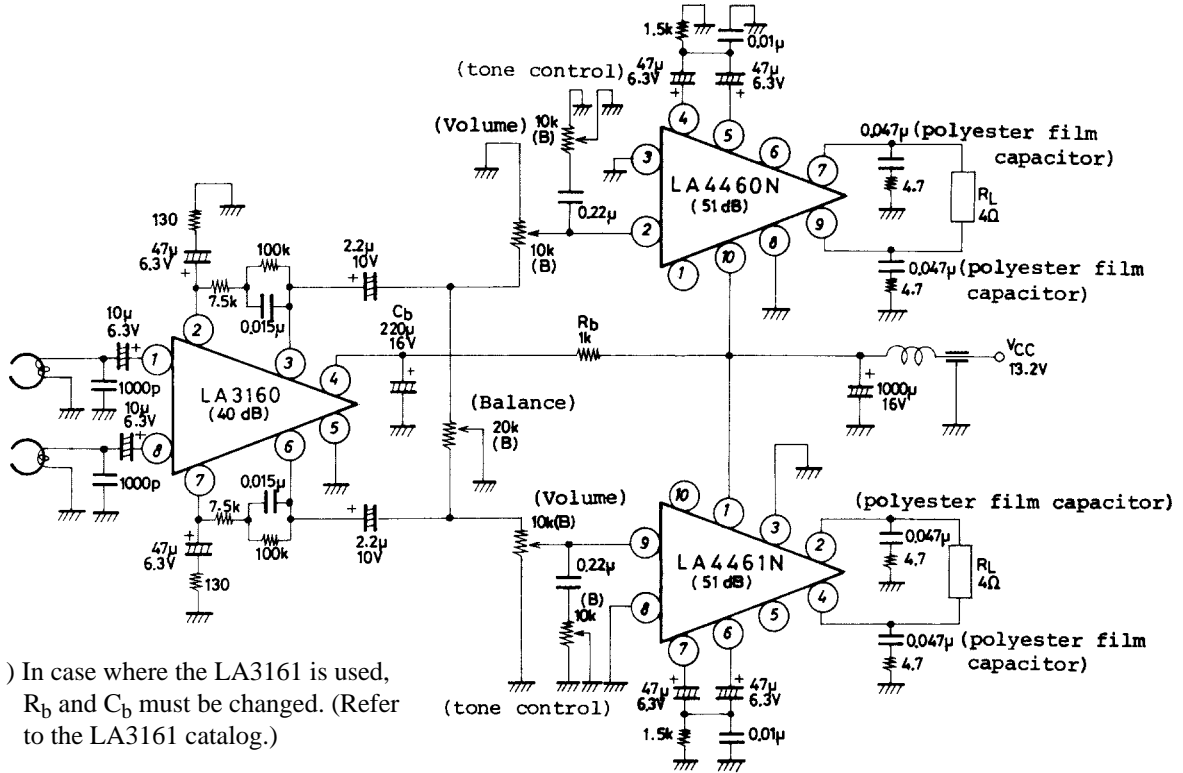

Note ) In case where the LA3161 is used,  $R_b$  and  $C_b$  must be changed. (Refer to the LA3161 catalog.)

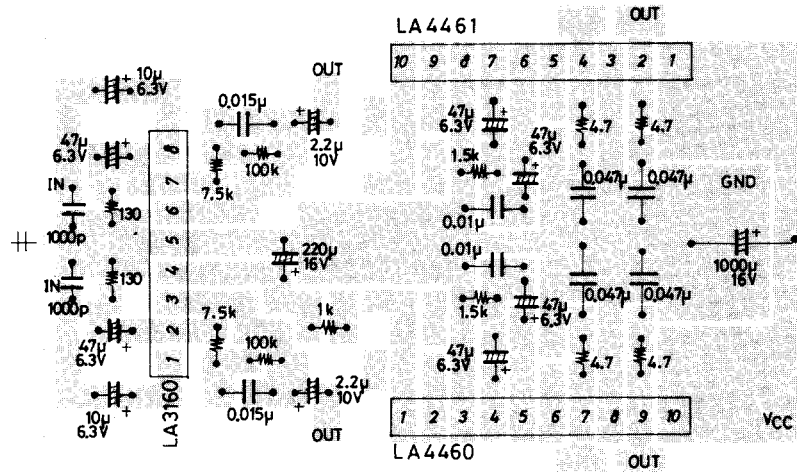

Sample Printed Circuit Pattern (42 x 65mm<sup>2</sup>, Cu-foiled side)

Example of oscillation compensation where feedthrough capacitors and used at the output terminals.

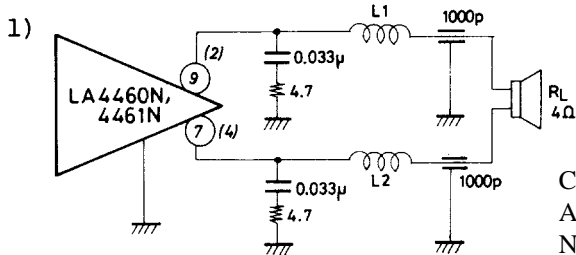

Coil used :  
 Air core            Inner diameter : 8φ  
 Number of turns : 6 turns  
 Wire size : UEW 1.5  
 Winding method : solenoid (0.3μH)

Connect each coil, L1 and L2, in series with each output terminal, where  $L_1=L_2$ .

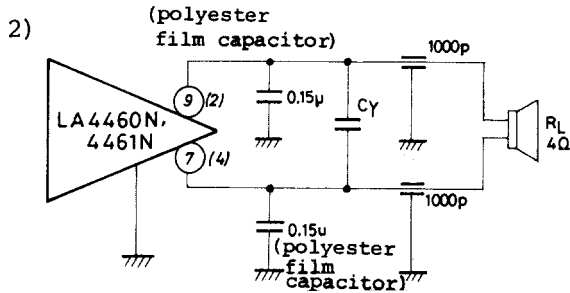

Cy is a semiconductor ceramic capacitor (B.C.) of 0.5 $\mu$ F.

## Note on LA4460N/4461N Usage

### · Maximum ratings

When the IC is used in the vicinity of the maximum ratings, a minor change in the conditions could result in exceeding the maximum ratings, and this may lead the IC to damage. Therefore sufficient precautions should be taken in this case.

### · Short-circuiting among pin terminals

Damage or deterioration could result if the power is turned on with pins short-circuited. Therefore always make sure the pins are not bridged by solder, etc. when mounting the IC on the PC board and turn the power on.

### · Printed circuit board

In designing a printed circuit board, refer to the foil pattern example attached. Also make sure no feedback loop exists between the input and output circuits.

### · Others

The IC is an OCL type power IC in which a bridge connection is made. Care should be given to the ground connections of the test equipment so that the ground of the test equipment (VTVM, distortion analyzer, oscilloscope, etc.) connected to the output terminals are not commonly connected to those of the test equipment connected to the input terminals.

- Specifications of any and all SANYO products described or contained herein stipulate the performance, characteristics, and functions of the described products in the independent state, and are not guarantees of the performance, characteristics, and functions of the described products as mounted in the customer's products or equipment. To verify symptoms and states that cannot be evaluated in an independent device, the customer should always evaluate and test devices mounted in the customer's products or equipment.
- SANYO Electric Co., Ltd. strives to supply high-quality high-reliability products. However, any and all semiconductor products fail with some probability. It is possible that these probabilistic failures could give rise to accidents or events that could endanger human lives, that could give rise to smoke or fire, or that could cause damage to other property. When designing equipment, adopt safety measures so that these kinds of accidents or events cannot occur. Such measures include but are not limited to protective circuits and error prevention circuits for safe design, redundant design, and structural design.
- In the event that any or all SANYO products(including technical data, services) described or contained herein are controlled under any of applicable local export control laws and regulations, such products must not be exported without obtaining the export license from the authorities concerned in accordance with the above law.
- No part of this publication may be reproduced or transmitted in any form or by any means, electronic or mechanical, including photocopying and recording, or any information storage or retrieval system, or otherwise, without the prior written permission of SANYO Electric Co., Ltd.
- Any and all information described or contained herein are subject to change without notice due to product/technology improvement, etc. When designing equipment, refer to the "Delivery Specification" for the SANYO product that you intend to use.
- Information (including circuit diagrams and circuit parameters) herein is for example only ; it is not guaranteed for volume production. SANYO believes information herein is accurate and reliable, but no guarantees are made or implied regarding its use or any infringements of intellectual property rights or other rights of third parties.

This catalog provides information as of February, 2000. Specifications and information herein are subject to change without notice.