

**TOP VIEW**

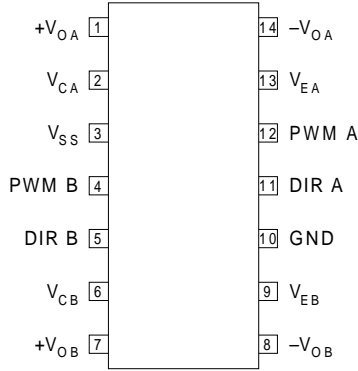

**J Package – 14 Pin Ceramic DIP**  
**N Package – 14 Pin Plastic DIP**  
**D Package – 14 Pin Plastic (150) SOIC**

**200mA DUAL H-BRIDGE**

**FEATURES**

- 200mA Continuous output current per bridge (100mA for IP1Mxx, IP2Mxx)
- Internal output clamp diodes
- Hysteretic logic inputs for noise immunity
- Thermal shutdown protection
- Peak current limit protection
- Crossover current blanking
- Separate +5V logic supply for minimum power dissipation (1M10 series only)
- Separate +7V to +36V logic supply (1M12 series only)

**Order Information**

Part Number	J-Pack 14 Pin	N-Pack 14 Pin	D-14 14 Pin	Temp. Range	<b>Note:</b> To order, add the package identifier to the part number. eg. IP1M10J IP2M10D-14 IP3M12N
IP1M10	✓			-55 to +125°C	
IP2M10	✓	✓	✓	-40 to +85°C	
IP3M10	✓	✓	✓	0 to +70°C	
IP1M12	✓			-55 to +125°C	
IP2M12	✓	✓	✓	-40 to +85°C	
IP3M12	✓	✓	✓	0 to +70°C	

**ABSOLUTE MAXIMUM RATINGS** ( $T_{case} = 25^{\circ}C$  unless otherwise stated)

Parameter	Description	1M10 Series	1M12 Series
$V_{SS}$	Logic Supply Voltage	+7V	+40V
$V_C$	Driver Supply Voltage	+40V	+40V
	Logic Inputs	-0.3 to +40V	-0.3 to +40V
	Output Current	±250mA	±250mA
	Peak Output Current	Internally Limited	Internally Limited
$P_D$	Power Dissipation	$T_A = 25^{\circ}C$	1W
	Derate above 50°C		10mW/°C
$P_D$	Power Dissipation	$T_C = 25^{\circ}C$	2W
	Derate above 25°C		16mW/°C
$T_J$	Operating Junction Temperature	See Ordering Information	
$T_{STG}$	Storage Temperature Range	-65 to +150°C	

**DESCRIPTION**

The IP1M10 and IP1M12 series each contain two full H-bridge power drivers capable of delivering 200 mA continuous output current per channel (100mA for 1Mxx / 2Mxx). Each bridge may be run from its own supply voltage of up to 36V and is controlled by 2 high voltage protected logic level inputs with internal hysteresis for noise immunity.

Protection features include thermal shutdown, peak current limiting, crossover current blanking, and internal output clamp diodes. Logic supply current is provided by a separate pin so that standby power dissipation may be minimised. The IP1M10 series requires a +5V logic supply while the IP1M12 series requires a logic supply voltage of +7V or greater, and is typically used in single supply applications.

The IP1M10 and IP1M12 are available in a 14 lead ceramic DIP while the IP2M10, IP2M12, IP3M10, IP3M12 are available in the 14 lead ceramic DIP, 14 lead plastic DIP, and 14 lead plastic SOIC packages.

**BLOCK DIAGRAM**

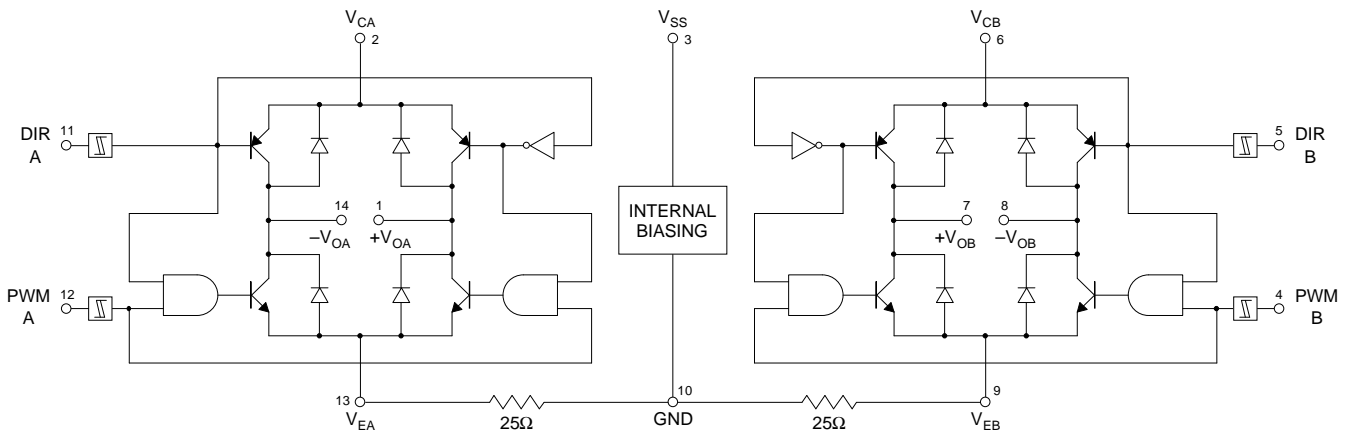

INPUTS		OUTPUTS	
DIR	PWM	+V <sub>O</sub>	-V <sub>O</sub>
LOW	LOW	Z*	HIGH
LOW	HIGH	LOW	HIGH
HIGH	LOW	HIGH	Z*
HIGH	HIGH	HIGH	LOW

\* Z = High Impedance.

**RECOMMENDED OPERATING CONDITIONS**

V <sub>SS</sub>	Logic Supply Voltage	1M10 Series 1M12 Series	+4.75 to +5.25V +7 to +36V
V <sub>C</sub>	Driver Supply Voltage		+4.75 to +36V
	Logic Inputs		0 to +36V
	Output Current, DC	1Mxx / 2Mxx Series 3Mxx Series	±100mA ±200mA
	Peak Output Current	1Mxx / 2Mxx Series 3Mxx Series	±125mA ±250mA
T <sub>AMB</sub>	Operating Ambient Temperature Range	1Mxx Series 2Mxx Series 3Mxx Series	-55 to +125°C -40 to +85°C 0 to +70°C

**ELECTRICAL CHARACTERISTICS** (Over Full Operating Temperature Range)

Parameter		Test Conditions	Min.	Typ.	Max.	Units
Logic Supply Voltage (Pin 3)	1M10 Series	$V_{SS} = +5.25V$ $I_{LOADS} = 0$		5	12	mA
		$V_{SS} = +5.25V$ $I_{LOADS} = 100mA$		8	20	
		$V_{SS} = +5.25V$ $I_{LOADS} = 200mA$		12	28	
Logic Supply Voltage (Pin 3)	1M12 Series	$V_{SS} = +36V$ $I_{LOADS} = 0$		8	18	mA
		$V_{SS} = +36V$ $I_{LOADS} = 100mA$		1	25	
		$V_{SS} = +20V$ $I_{LOADS} = 200mA$		15	32	
Quiescent Bridge Current (Pin 2 or 6)		$I_{LOAD} = 0$		2.5	8	mA
PWM Input Threshold (Pins 4 and 12)	Falling		0.8	1.5	2	V
	Rising		1.2	2.5	3	
	Hysteresis		0.4	1		
PWM Input Current (Pins 4 and 12)	Low	$V_{IN} = 0$		-20	-100	$\mu A$
	High	$V_{IN} = 36V$		0.1	$\pm 10$	
DIR Input Threshold (Pins 5 and 11)	Falling		0.8	1.5	2	V
	Rising		1.2	2.3	3	
	Hysteresis		0.2	0.8		
DIR Input Current (Pins 5 and 11)	Low	$V_{IN} = 0$		-20	-100	$\mu A$
	High	$V_{IN} = 36V$		0.1	$\pm 10$	
Total Saturation Voltage $V_{SAT(SINK)} + V_{SAT(SOURCE)}$		$I_{LOAD} = 100mA$		1.8	2.25	V
		$I_{LOAD} = 200mA$ 3M10 / 3M12 Only		2.1	2.7	
Diode Forward Voltage		$I_{DIODE} = 100mA$		1.1	1.4	V
		$I_{DIODE} = 200mA$		1.2	1.6	
Output Leakage Current (Pins 1, 7, 8 and 14)	Low	$V_O = 0$ $V_C = 36V$		1	100	$\mu A$
	High	$V_O = V_C = 36V$		1	100	

**SWITCHING CHARACTERISTICS** @  $T_{AMB} = 25^{\circ}C$

Parameter	Test Conditions	Min.	Typ.	Max.	Units
Sink Turn-On Delay	$\Delta t: V_i = V_{i(TH)}$ to $V_O = V_S / 2$		1250		ns
Sink Current Rise Time	$\Delta t: I_O = (0.1 \text{ to } 0.9) I_{LOAD}$		200		
Sink Turn-Off Delay	$\Delta t: V_i = V_{i(TH)}$ to $V_O = V_S / 2$		300		
Sink Current Fall Time	$\Delta t: I_O = (0.9 \text{ to } 0.1) I_{LOAD}$		200		
Source Turn-On Delay	$\Delta t: V_i = V_{i(TH)}$ to $V_O = V_S / 2$		800		ns
Source Rise Time	$\Delta t: I_O = (0.1 \text{ to } 0.9) I_{LOAD}$		400		
Source Turn-Off Delay	$\Delta t: V_i = V_{i(TH)}$ to $V_O = V_S / 2$		1000		
Source Fall Time	$\Delta t: I_O = (0.9 \text{ to } 0.1) I_{LOAD}$		500		
Sink to Source Deadtime			500		ns
Source to Sink Deadtime			250		

TYPICAL PERFORMANCE CHARACTERISTICS — ERROR AMPLIFIER

Output State vs DIR Input Voltage

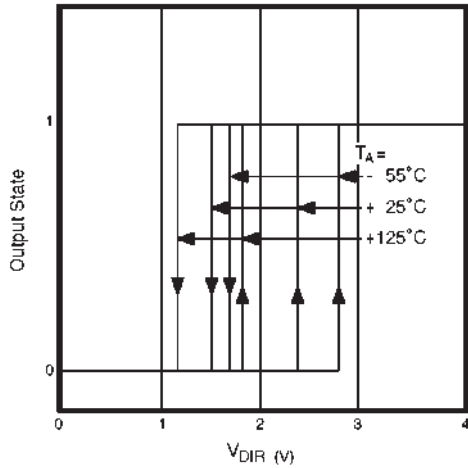

Output State vs PWM Input Voltage

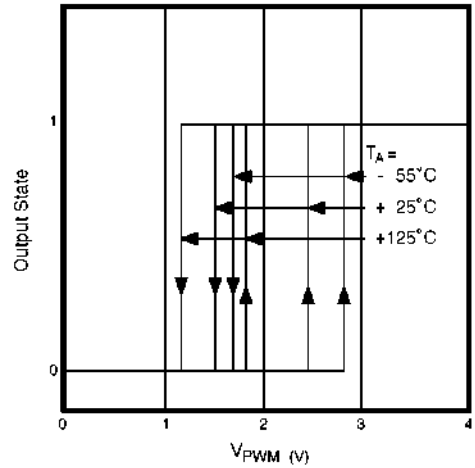

Diode Forward Voltage vs Ambient Temperature

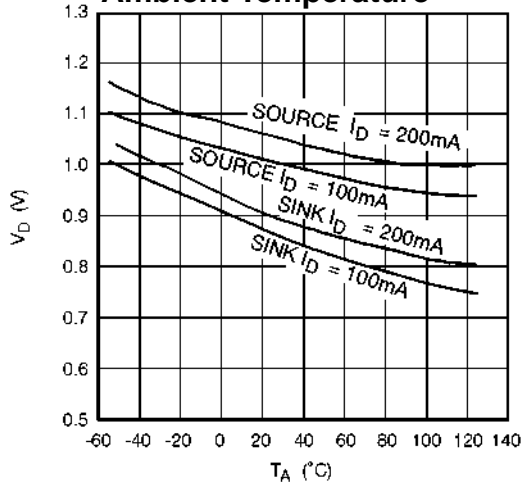

Total Saturation Voltage vs Ambient Temperature

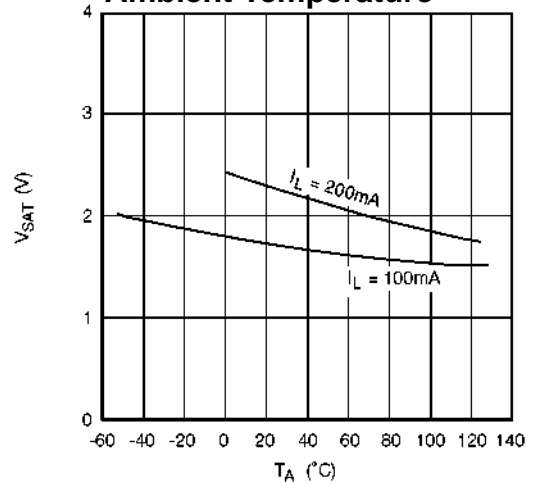

Peak Output Current vs Ambient Temperature

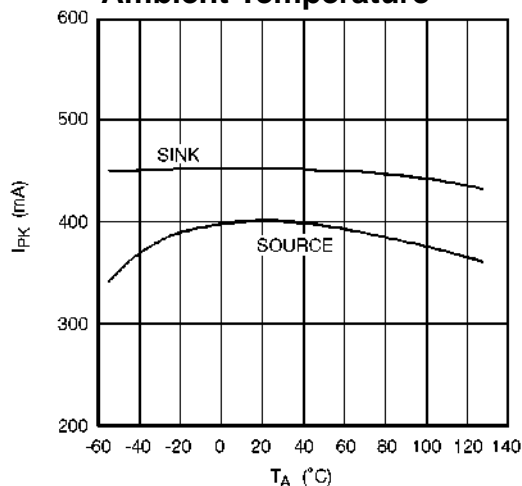

Logic Supply Current vs Ambient Temperature

