



16-Bit, Dual, Parallel Input, Multiplying Digital-to-Analog Converter

FEATURES

- $\pm 0.5\text{LSB DNL}$
- $\pm 1\text{LSB INL}$
- **Low Noise:** $12\text{nV}/\sqrt{\text{Hz}}$
- **Low Power Operation:**
 $I_{\text{DD}} = 1\mu\text{A per Channel at } 2.7\text{V}$
- **2mA Full-Scale Current, with $V_{\text{REF}} = 10\text{V}$**
- **Settling Time:** $0.5\mu\text{s}$
- **16-Bit Monotonic**
- **4-Quadrant Multiplying Reference Inputs**
- **Reference Bandwidth:** 10MHz
- **Reference Input:** $\pm 18\text{V}$
- **Reference Dynamics:** -105 THD
- **Midscale or Zero Scale Reset**
- **Analog Power Supply:** $+2.7\text{V to } +5.5\text{V}$
- **TSSOP-38 Package**
- **Industry-Standard Pin Configuration**
- **Pin-Compatible with the 14-Bit [DAC8805](#)**
- **Temperature Range:** $-40^{\circ}\text{C to } +125^{\circ}\text{C}$

APPLICATIONS

- **Automatic Test Equipment**
- **Instrumentation**
- **Digitally Controlled Calibration**
- **Industrial Control PLCs**

DESCRIPTION

The DAC8822 dual, multiplying digital-to-analog converter (DAC) is designed to operate from a single 2.7V to 5.5V supply.

The applied external reference input voltage V_{REF} determines the full-scale output current. An internal feedback resistor (R_{FB}) provides temperature tracking for the full-scale output when combined with an external, current-to-voltage (I/V) precision amplifier.

A RSTSEL pin allows system reset assertion ($\overline{\text{RS}}$) to force all registers to zero code when RSTSEL = '0', or to midscale code when RSTSEL = '1'. Additionally, an internal power-on reset forces all registers to zero or midscale code at power-up, depending on the state of the RSTSEL pin.

A parallel interface offers high-speed communications. The DAC8822 is packaged in a space-saving TSSOP-38 package and has an industry-standard pinout. The device is specified from -40°C to $+125^{\circ}\text{C}$.

For a 14-bit, pin-compatible version, see the [DAC8805](#).

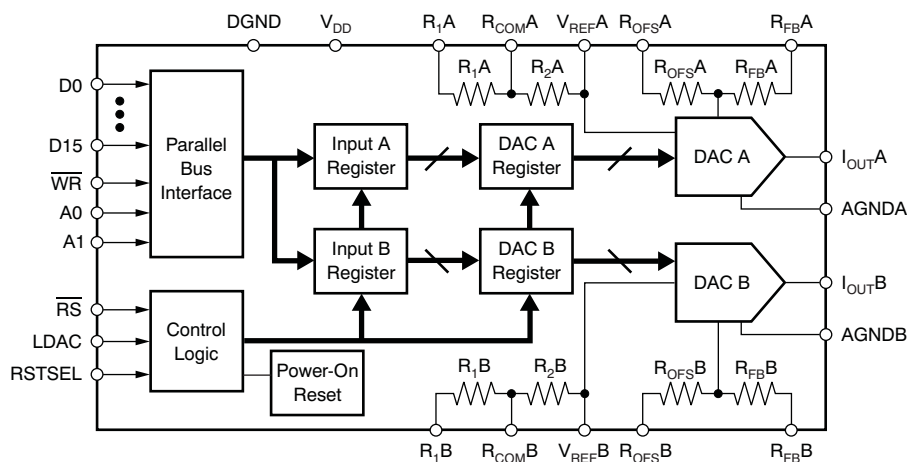

Please be aware that an important notice concerning availability, standard warranty, and use in critical applications of Texas Instruments semiconductor products and disclaimers thereto appears at the end of this data sheet.

All trademarks are the property of their respective owners.



This integrated circuit can be damaged by ESD. Texas Instruments recommends that all integrated circuits be handled with appropriate precautions. Failure to observe proper handling and installation procedures can cause damage.

ESD damage can range from subtle performance degradation to complete device failure. Precision integrated circuits may be more susceptible to damage because very small parametric changes could cause the device not to meet its published specifications.

ORDERING INFORMATION⁽¹⁾

PRODUCT	RELATIVE ACCURACY (LSB)	DIFFERENTIAL NONLINEARITY (LSB)	PACKAGE-LEAD (DESIGNATOR)	SPECIFIED TEMPERATURE RANGE	PACKAGE MARKING
DAC8822QB	±2	±1	TSSOP-38 (DBT)	–40°C to +125°C	DAC8822
DAC8822QC	±1	±1	TSSOP-38 (DBT)	–40°C to +125°C	DAC8822

(1) For the most current package and ordering information see the Package Option Addendum at the end of this document, or see the TI web site at www.ti.com.

ABSOLUTE MAXIMUM RATINGS

over operating free-air temperature range (unless otherwise noted)⁽¹⁾

	DAC8822	UNIT
V _{DD} to GND	–0.3 to +7	V
Digital input voltage to GND	–0.3 to +V _{DD} + 0.3	V
V (I _{OUT}) to GND	–0.3 to +V _{DD} + 0.3	V
REF, R _{OFS} , R _{FB} , R ₁ , R _{COM} to AGND, DGND	±25	V
Operating temperature range	–40 to +125	°C
Storage temperature range	–65 to +150	°C
Junction temperature range (T _J max)	+150	°C
Power dissipation	(T _J max – T _A) / R _{θJA}	W
Thermal impedance, R _{θJA}	53	°C/W
ESD rating	Human Body Model (HBM)	4000
	Charged Device Model (CDM)	500

(1) Stresses above those listed under *Absolute Maximum Ratings* may cause permanent damage to the device. Exposure to absolute maximum conditions for extended periods may affect device reliability.

ELECTRICAL CHARACTERISTICS

All specifications at $T_A = -40^\circ\text{C}$ to $+125^\circ\text{C}$, $V_{DD} = +2.7\text{V}$ to $+5.5\text{V}$, $I_{OUT} = \text{virtual GND}$, $\text{GND} = 0\text{V}$, and $V_{REF} = 10\text{V}$, unless otherwise noted.

PARAMETER	CONDITIONS	DAC8822			UNITS		
		MIN	TYP	MAX			
STATIC PERFORMANCE							
Resolution		16			Bits		
Relative accuracy	INL	DAC8822QB			±2	LSB	
		DAC8822QC			±1	LSB	
Differential nonlinearity	DNL			±0.5	±1	LSB	
Output leakage current	Data = 0000h, $T_A = +25^\circ\text{C}$			10	nA		
Output leakage current	Data = 0000h, Full temperature range			20	nA		
Full-scale gain error	Unipolar, data = FFFFh			±1	±4	mV	
	Bipolar, data = FFFFh			±1	±4	mV	
Full-scale temperature coefficient				±1	±2	ppm/°C	
Bipolar zero error	$T_A = +25^\circ\text{C}$			±1	±3	mV	
	Full temperature range			±1	±3	mV	
Power-supply rejection ratio	PSRR $V_{DD} = 5\text{V} \pm 10\%$			±0.2	±1.0	LSB/V	
OUTPUT CHARACTERISTICS⁽¹⁾							
Output current				2	mA		
Output capacitance	Code dependent			50	pF		
REFERENCE INPUT							
Reference voltage range	V_{REF}			-18	18	V	
Input resistance (unipolar)	R_{REF}			4	5	6	kΩ
Input capacitance				5		pF	
R_1, R_2				4	5	6	kΩ
Feedback and offset resistance	R_{OFS}, R_{FB}			8	10	12	kΩ
LOGIC INPUTS AND OUTPUT⁽¹⁾							
Input low voltage	V_{IL}	$V_{DD} = +2.7\text{V}$			0.6	V	
	V_{IL}	$V_{DD} = +5\text{V}$			0.8	V	
Input high voltage	V_{IH}	$V_{DD} = +2.7\text{V}$	2.1			V	
	V_{IH}	$V_{DD} = +5\text{V}$	2.4			V	
Input leakage current	I_{IL}			0.001	1	μA	
Input capacitance	C_{IL}				8	pF	
POWER REQUIREMENTS							
Supply voltage	V_{DD}			2.7	5.5	V	
Supply current	I_{DD}	Normal operation, logic inputs = 0V			3	6	μA
		$V_{DD} = +4.5\text{V}$ to $+5.5\text{V}$, $V_{IH} = V_{DD}$ and $V_{IL} = \text{GND}$			3	6	μA
		$V_{DD} = +2.7\text{V}$ to $+3.6\text{V}$, $V_{IH} = V_{DD}$ and $V_{IL} = \text{GND}$			1	3	μA
AC CHARACTERISTICS⁽¹⁾⁽²⁾							
Output current settling time	t_s	To 0.0015% of full-scale, data = 0000h to FFFFh to 0000h			0.5	μs	
Reference multiplying BW	BW - 3dB	$V_{REF} = 5V_{PP}$, data = FFFFh, 2-quadrant mode			10	MHz	
DAC glitch impulse		$V_{REF} = 0\text{V}$ to 10V , data = 7FFFh to 8000h to 7FFFh			5	nV-s	
Feedthrough error	V_{OUT}/V_{REF}	Data = 0000h, $V_{REF} = 100\text{kHz}$, $\pm 10V_{PP}$, 2-quadrant mode			-70	dB	
Crosstalk error	V_{OUT}/V_{REFB}	Data = 0000h, $V_{REFB} = 100mV_{RMS}$, $f = 100\text{kHz}$			-100	dB	
Digital feedthrough		LDAC = logic low, $V_{REF} = -10\text{V}$ to $+10\text{V}$ Any code change			1	nV-s	
Total harmonic distortion	THD	$V_{REF} = 6V_{RMS}$, data = FFFFh, $f = 1\text{kHz}$			-105	dB	
Output noise density	e_n	$f = 1\text{kHz}$, BW = 1Hz, 2-quadrant mode			12	nV/√Hz	

(1) Specified by design and characterization; not production tested.

(2) All ac characteristic tests are performed in a closed-loop system using a THS4011 I-to-V converter amplifier.

PIN ASSIGNMENTS

**DBT PACKAGE
TSSOP-38
(TOP VIEW)**

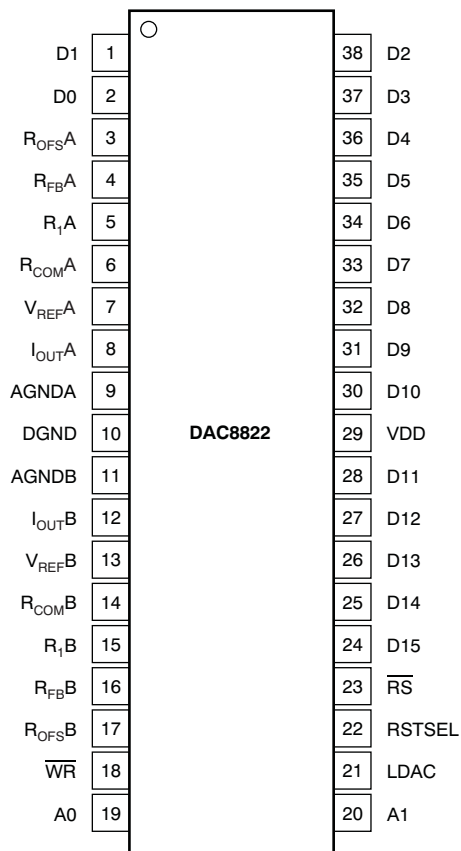

PIN ASSIGNMENTS (continued)
Table 1. TERMINAL FUNCTIONS

PIN #	NAME	DESCRIPTION
1, 2, 24-28, 30-38	D0-D15	Digital Input Data Bits D0 to D15. Signal level must be $\leq V_{DD} + 0.3V$. D15 is MSB.
3	R _{OFFS} A	Bipolar Offset Resistor A. Accepts up to $\pm 18V$. In 2-quadrant mode, R _{OFFS} A ties to R _{FB} A. In 4-quadrant mode, R _{OFFS} A ties to R ₁ A and the external reference.
4	R _{FB} A	Internal Matching Feedback Resistor A. Connects to the external op amp for I-V conversion.
5	R ₁ A	4-Quadrant Resistor. In 2-quadrant mode, R ₁ A shorts to the V _{REF} A pin. In 4-quadrant mode, R ₁ A ties to R _{OFFS} A and the reference input.
6	R _{COM} A	Center Tap Point of the Two 4-Quadrant Resistors, R ₁ A and R ₂ A. In 2-quadrant mode, R _{COM} A shorts to the V _{REF} pin. In 4-quadrant mode, R _{COM} A ties to the inverting node of the reference amplifier.
7	V _{REF} A	DAC A Reference Input in 2-Quadrant Mode, R ₂ Terminal in 4-Quadrant Mode. In 2-quadrant mode, V _{REF} A is the reference input with constant input resistance versus code. In 4-quadrant mode, V _{REF} A is driven by the external reference amplifier.
8	I _{OUT} A	DAC A Current Output. Connects to the inverting terminal of external precision I-V op amp for voltage output.
9	AGNDA	DAC A Analog Ground.
10	DGND	Digital Ground.
11	AGNDB	DAC B Analog Ground.
12	I _{OUT} B	DAC B Current Output. Connects to the inverting terminal of external precision I-V op amp for voltage output.
13	V _{REF} B	DAC B Reference Input in 2-Quadrant Mode, R ₂ Terminal in 4-Quadrant Mode. In 2-quadrant mode, V _{REF} B is the reference input with constant input resistance versus code. In 4-quadrant mode, V _{REF} B is driven by the external reference amplifier.
14	R _{COM} B	Center Tap Point of the Two 4-Quadrant Resistors, R ₁ B and R ₂ B. In 2-quadrant mode, R _{COM} B shorts to the V _{REF} pin. In 4-quadrant mode, R _{COM} B ties to the inverting node of the reference amplifier.
15	R ₁ B	4-Quadrant Resistor. In 2-quadrant mode, R ₁ B shorts to the V _{REF} B pin. In 4-quadrant mode, R ₁ B ties to R _{OFFS} B and the reference input.
16	R _{FB} B	Internal Matching Feedback Resistor B. Connects to external op amp for I-V conversion.
17	R _{OFFS} B	Bipolar Offset Resistor B. Accepts up to $\pm 18V$. In 2-quadrant mode, R _{OFFS} B ties to R _{FB} B. In 4-quadrant mode, R _{OFFS} B ties to R ₁ B and the external reference.
18	\overline{WR}	Write Control Digital Input In, Active Low. \overline{WR} enables input registers. Signal level must be $\leq V_{DD} + 0.3V$.
19	A0	Address 0. Signal level must be $\leq V_{DD} + 0.3V$.
20	A1	Address 1. Signal level must be $\leq V_{DD} + 0.3V$.
21	LDAC	Digital Input Load DAC Control. Signal level must be $\leq V_{DD} + 0.3V$. See the Function of Control Inputs table for details.
22	RSTSEL	Power-On Reset State. RSTSEL = 0 corresponds to zero-scale reset. RSTSEL = 1 corresponds to midscale reset. The signal level must be $\leq V_{DD} + 0.3V$.
23	\overline{RS}	Reset. Active low resets both input and DAC registers. Resets to zero-scale if RSTSEL= 0, and to midscale if RSTSEL = 1. Signal level must be equal to or less than VDD + 0.3 V.
29	V _{DD}	Positive Power Supply Input. The specified range of operation is 2.7V to 5.5V.

TIMING AND FUNCTIONAL INFORMATION

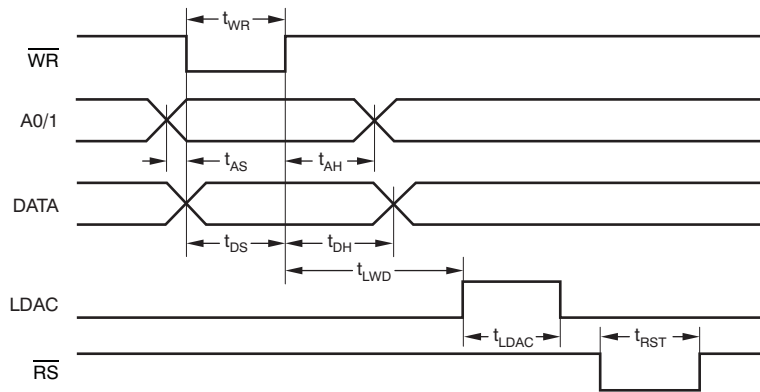

Figure 1. Timing Diagram

TIMING CHARACTERISTICS



All specifications at $T_A = -40^\circ\text{C}$ to $+125^\circ\text{C}$, $I_{OUT} = \text{virtual GND}$, $\text{GND} = 0\text{V}$, and $V_{REF} = 10\text{V}$, unless otherwise noted

PARAMETER	CONDITIONS	DAC8822			UNITS
		MIN	TYP	MAX	
Data to \overline{WR} setup time	$V_{DD} = +5.0\text{V}$	10			ns
	$V_{DD} = +2.7\text{V}$	10			ns
A0/1 to \overline{WR} setup time	$V_{DD} = +5.0\text{V}$	10			ns
	$V_{DD} = +2.7\text{V}$	10			ns
Data to \overline{WR} hold time	$V_{DD} = +5.0\text{V}$	0			ns
	$V_{DD} = +2.7\text{V}$	0			ns
A0/1 to \overline{WR} hold time	$V_{DD} = +5.0\text{V}$	0			ns
	$V_{DD} = +2.7\text{V}$	0			ns
\overline{WR} pulse width	$V_{DD} = +5.0\text{V}$	10			ns
	$V_{DD} = +2.7\text{V}$	10			ns
LDAC pulse width	$V_{DD} = +5.0\text{V}$	10			ns
	$V_{DD} = +2.7\text{V}$	10			ns
\overline{RS} pulse width	$V_{DD} = +5.0\text{V}$	10			ns
	$V_{DD} = +2.7\text{V}$	10			ns
\overline{WR} to LDAC delay time	$V_{DD} = +5.0\text{V}$	0			ns
	$V_{DD} = +2.7\text{V}$	0			ns

Table 2. Address Decoder Pins

A1	A0	OUTPUT UPDATE
0	0	DAC A
0	1	None
1	0	DAC A and DAC B
1	1	DAC B

Table 3. Function of Control Inputs

CONTROL INPUTS			REGISTER OPERATION
\overline{RS}	\overline{WR}	LDAC	
0	X	X	Asynchronous operation. Reset the input and DAC register to '0' when the RSTSEL pin is tied to DGND, and to midscale when RSTSEL is tied to V_{DD} .
1	0	0	Load the input register with all 16 data bits.
1	1	1	Load the DAC register with the contents of the input register.
1	0	1	The input and DAC register are transparent.
1			LDAC and \overline{WR} are tied together and programmed as a pulse. The 16 data bits are loaded into the input register on the falling edge of the pulse and then loaded into the DAC register on the rising edge of the pulse.
1	1	0	No register operation.

TYPICAL CHARACTERISTICS: $V_{DD} = +5V$

Channel A

LINEARITY ERROR
vs DIGITAL INPUT CODE

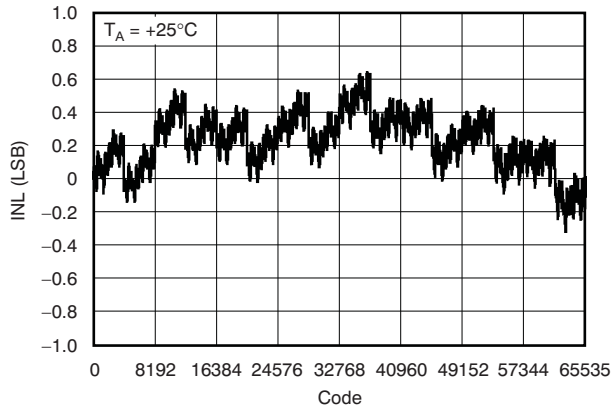

Figure 2.

DIFFERENTIAL LINEARITY ERROR
vs DIGITAL INPUT CODE

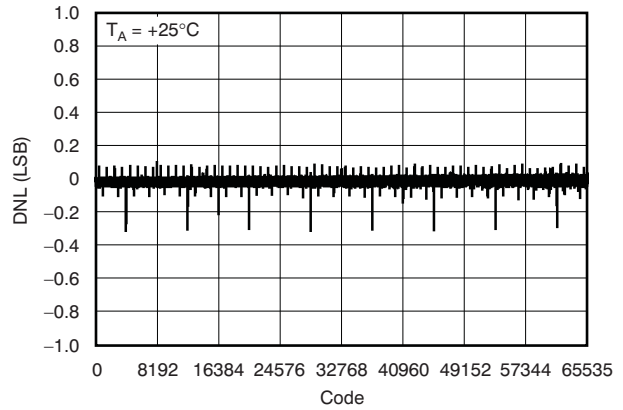

Figure 3.

LINEARITY ERROR
vs DIGITAL INPUT CODE

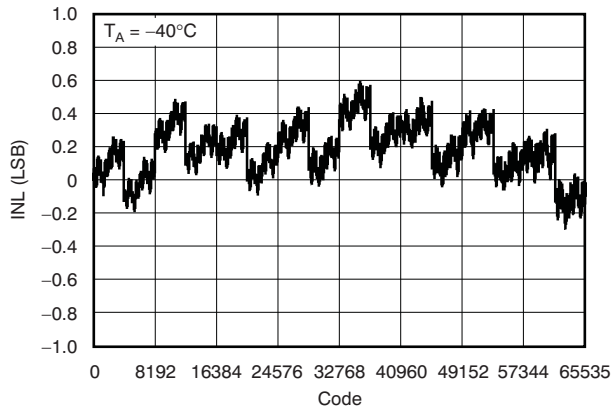

Figure 4.

DIFFERENTIAL LINEARITY ERROR
vs DIGITAL INPUT CODE

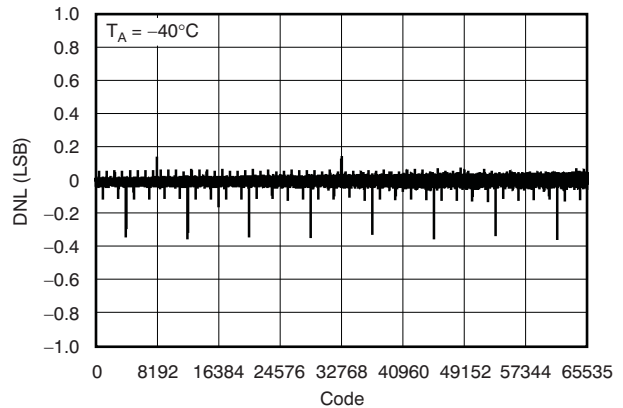

Figure 5.

LINEARITY ERROR
vs DIGITAL INPUT CODE

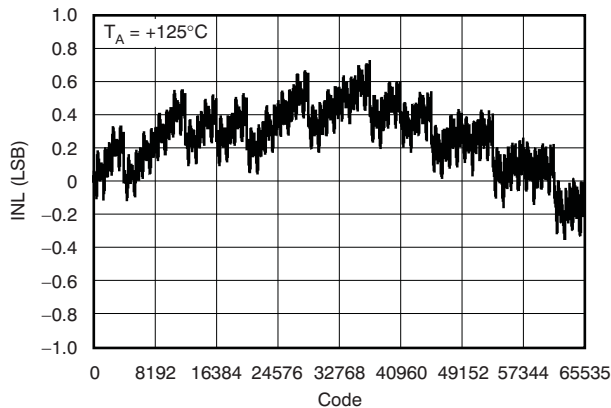

Figure 6.

DIFFERENTIAL LINEARITY ERROR
vs DIGITAL INPUT CODE

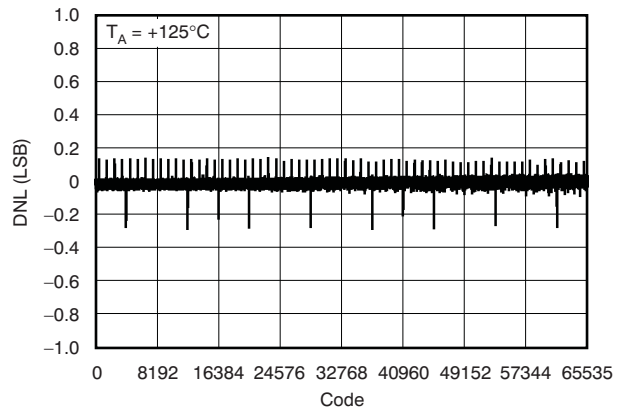

Figure 7.

TYPICAL CHARACTERISTICS: $V_{DD} = +5V$ (continued)

Channel B

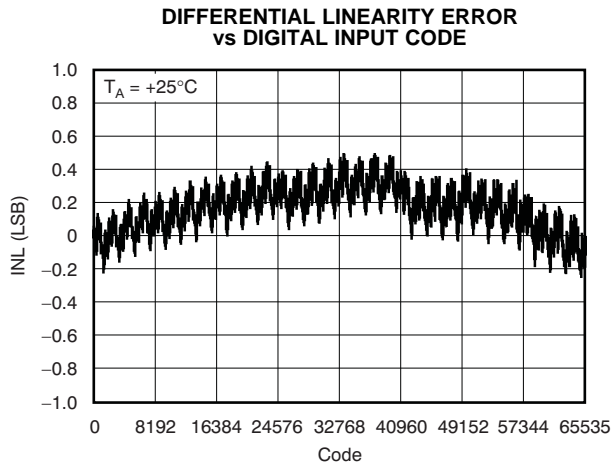

Figure 8.

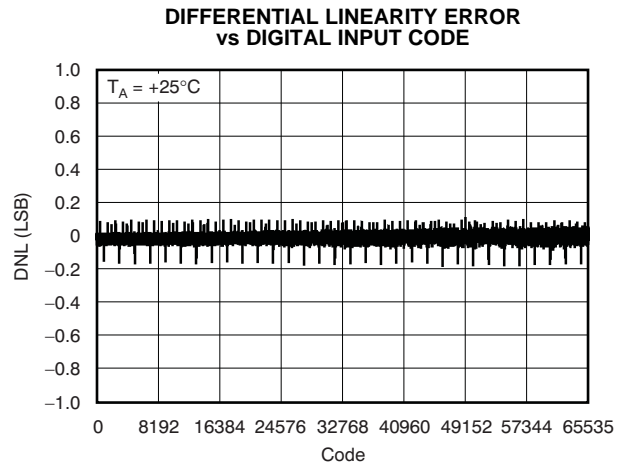

Figure 9.

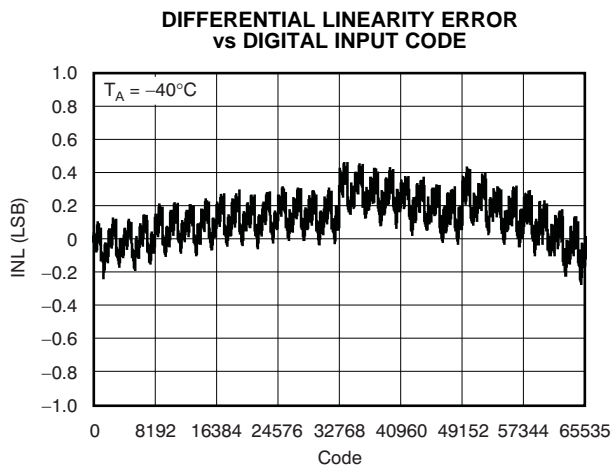

Figure 10.

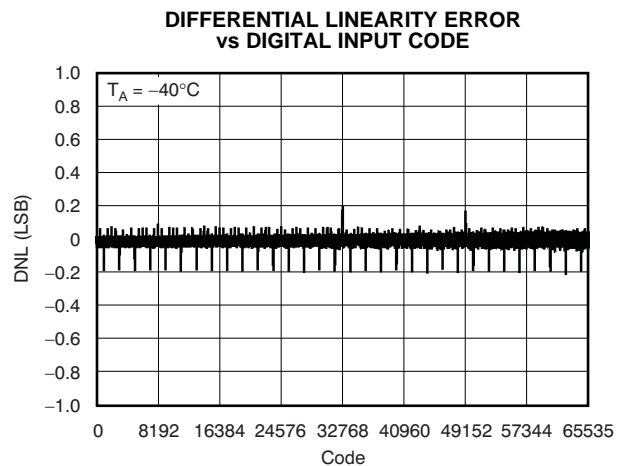

Figure 11.

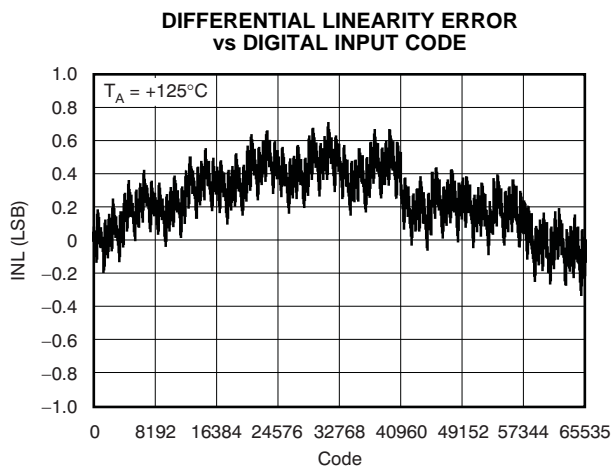

Figure 12.

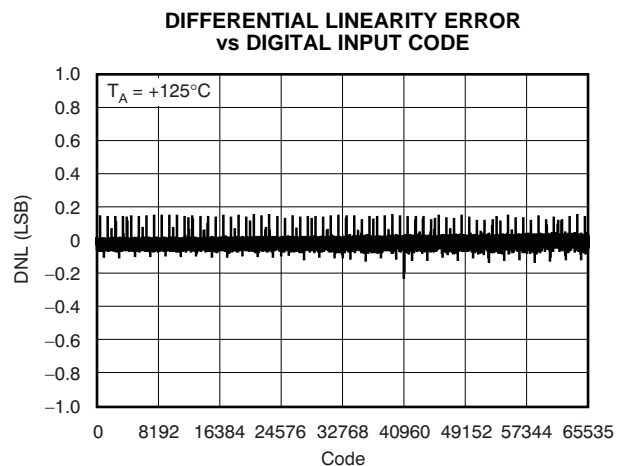

Figure 13.

TYPICAL CHARACTERISTICS: $V_{DD} = +5V$ (continued)

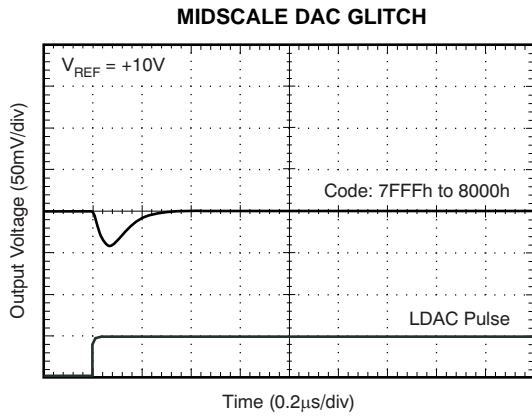

Figure 14.

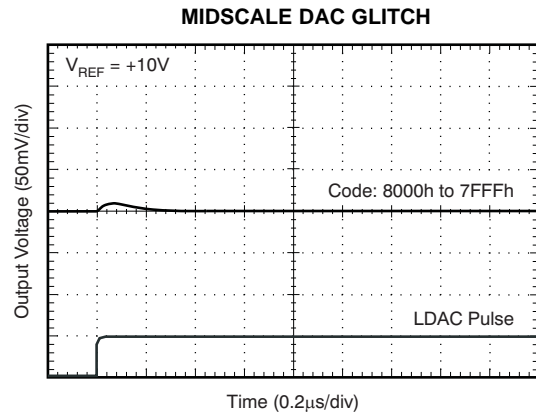

Figure 15.

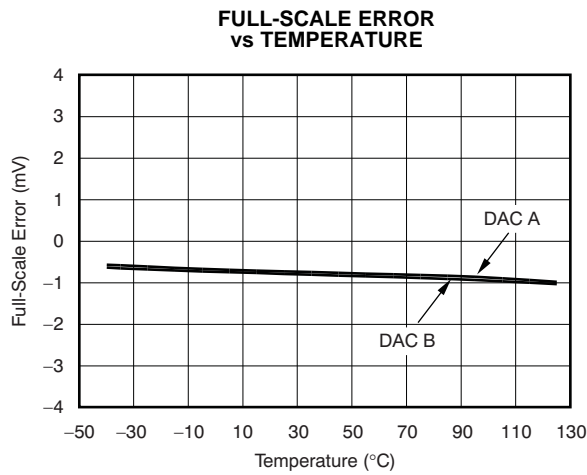

Figure 16.

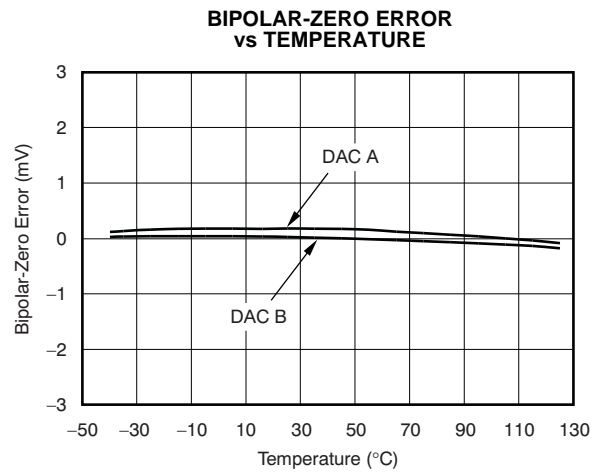

Figure 17.

TYPICAL CHARACTERISTICS: $V_{DD} = +2.7V$

Channel A

**LINEARITY ERROR
vs DIGITAL INPUT CODE**

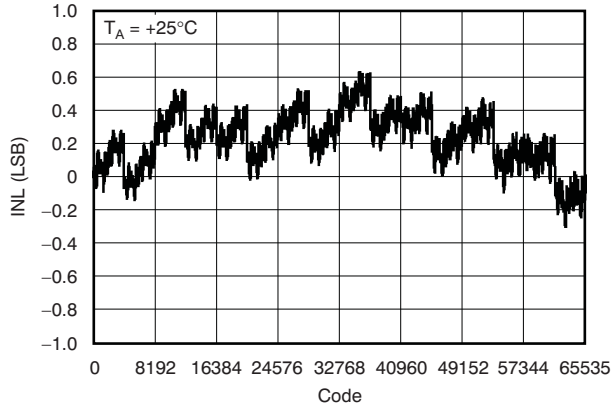

Figure 18.

**LINEARITY ERROR
vs DIGITAL INPUT CODE**

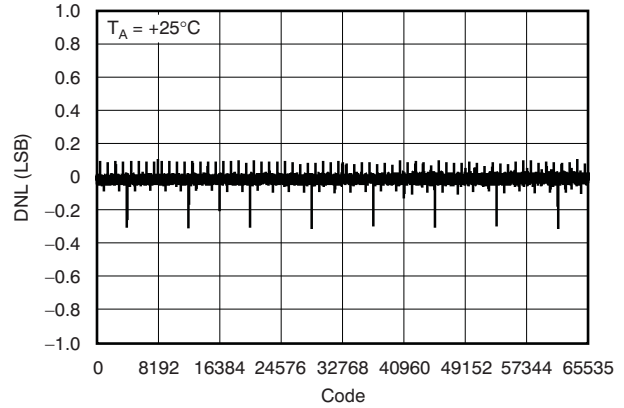

Figure 19.

**LINEARITY ERROR
vs DIGITAL INPUT CODE**

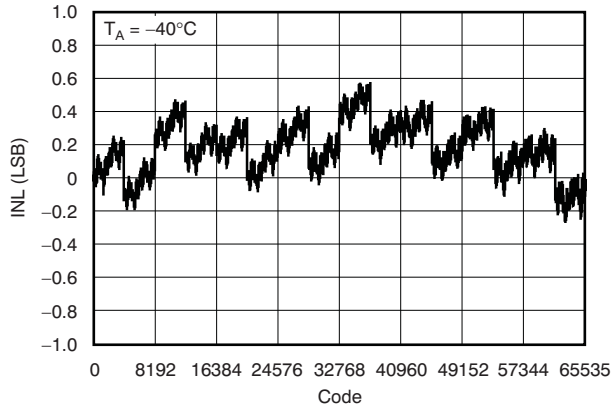

Figure 20.

**LINEARITY ERROR
vs DIGITAL INPUT CODE**

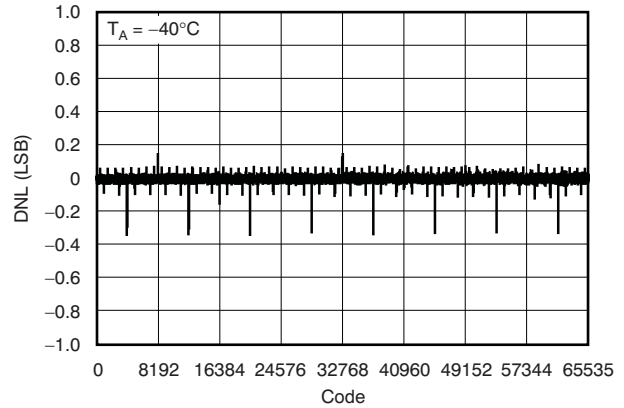

Figure 21.

**LINEARITY ERROR
vs DIGITAL INPUT CODE**

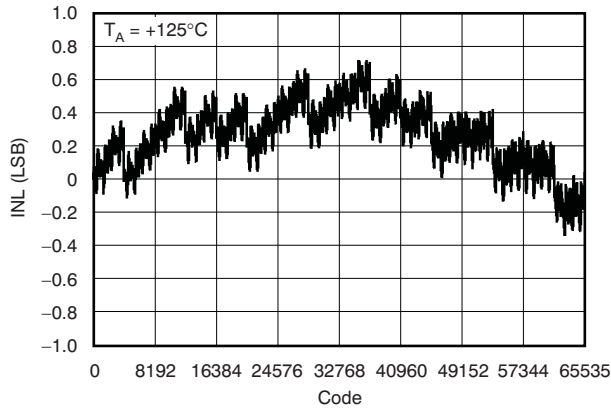

Figure 22.

**LINEARITY ERROR
vs DIGITAL INPUT CODE**

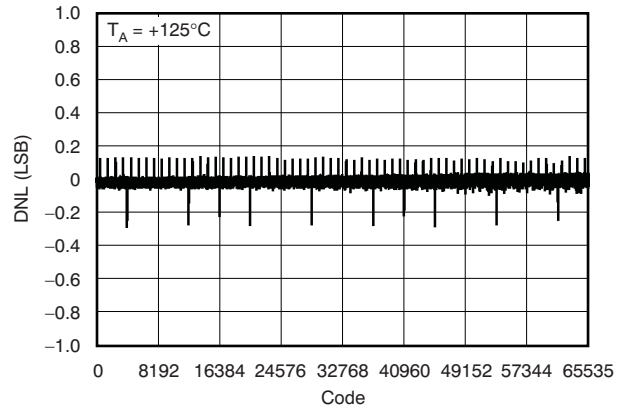

Figure 23.

TYPICAL CHARACTERISTICS: $V_{DD} = +2.7V$ (continued)

Channel B

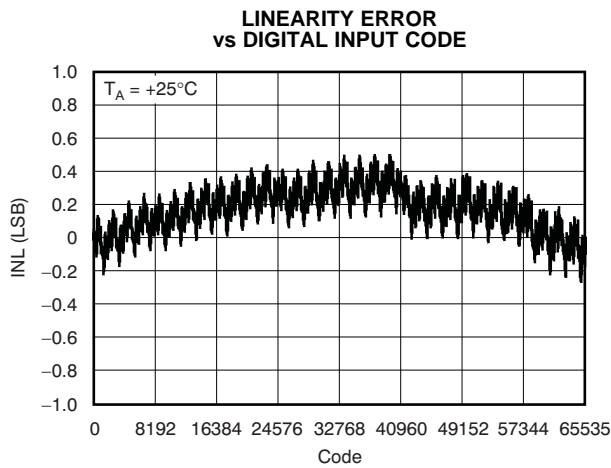

Figure 24.

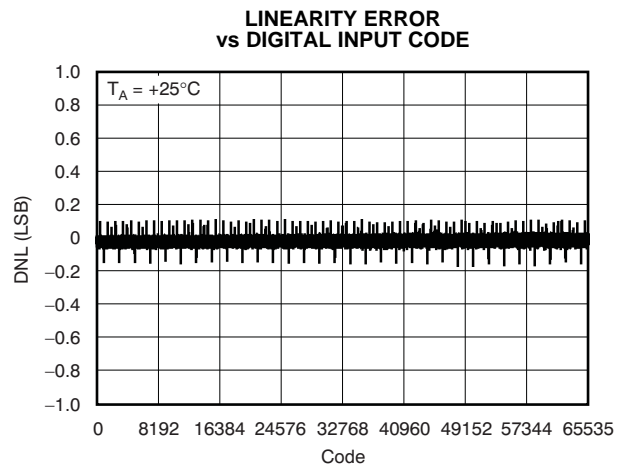

Figure 25.

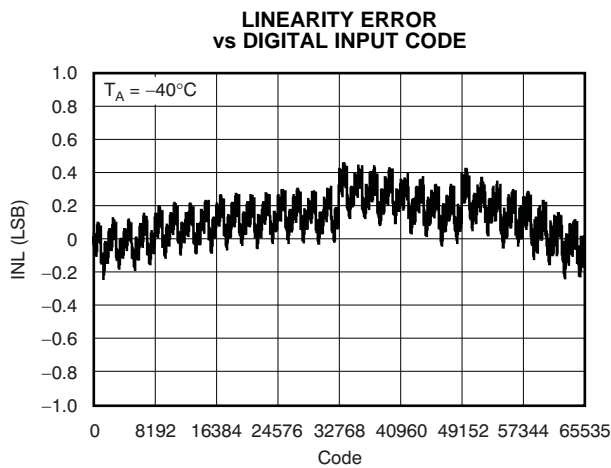

Figure 26.

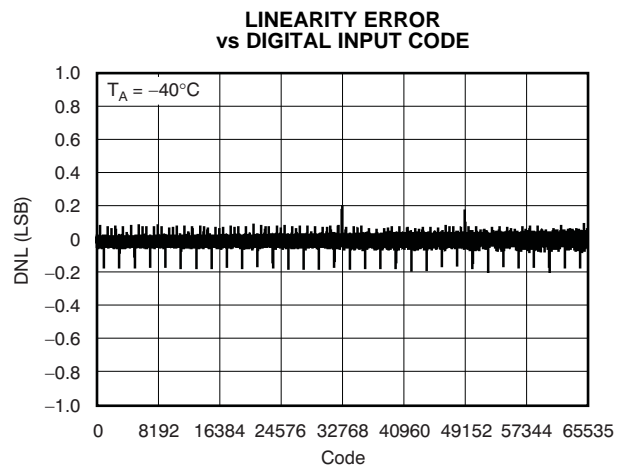

Figure 27.

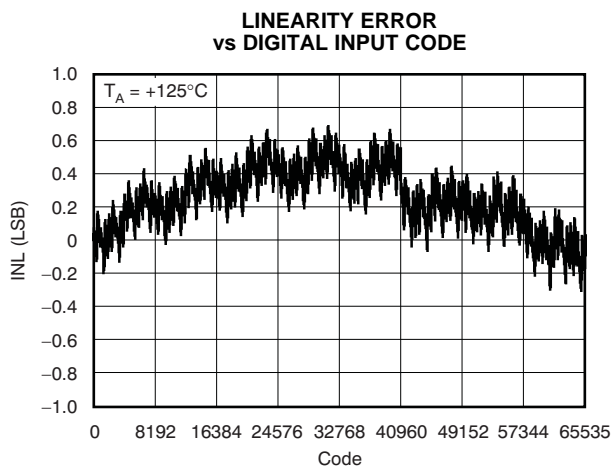

Figure 28.

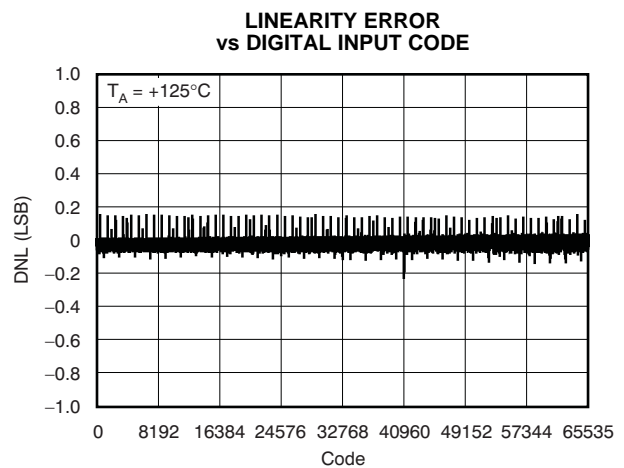

Figure 29.

TYPICAL CHARACTERISTICS: $V_{DD} = +2.7V$ (continued)

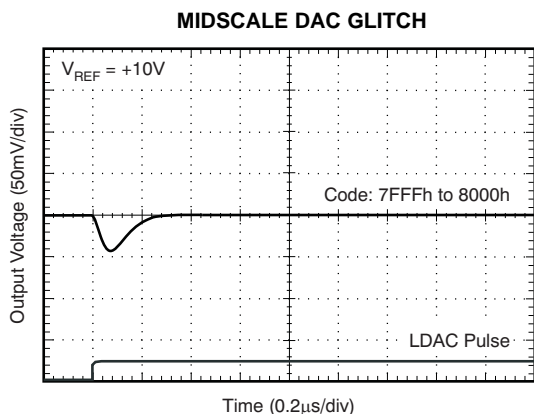

Figure 30.

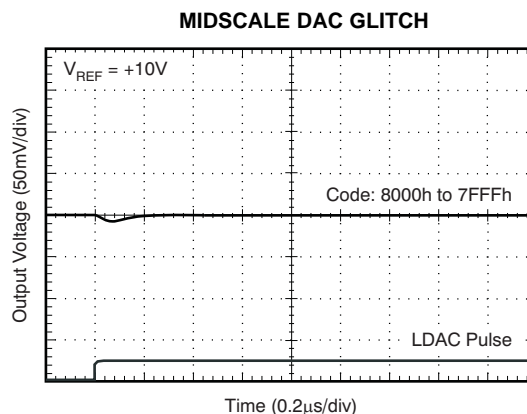

Figure 31.

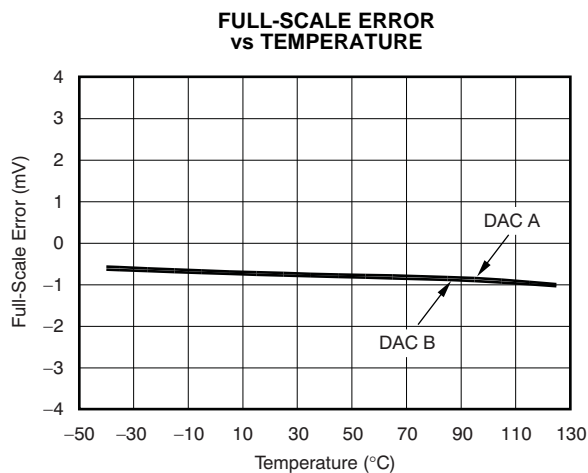

Figure 32.

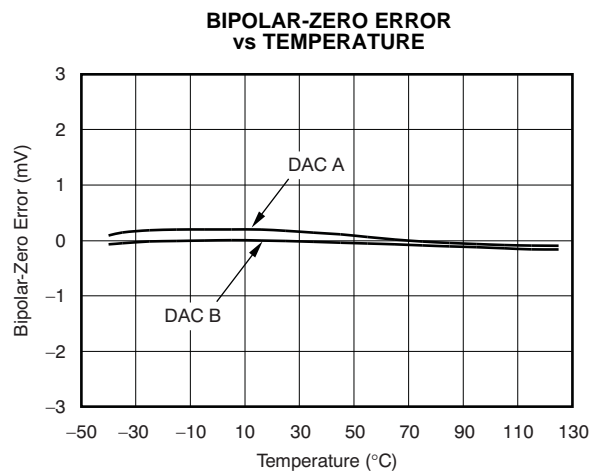

Figure 33.

TYPICAL CHARACTERISTICS: $V_{DD} = +2.7V$ and $+5V$

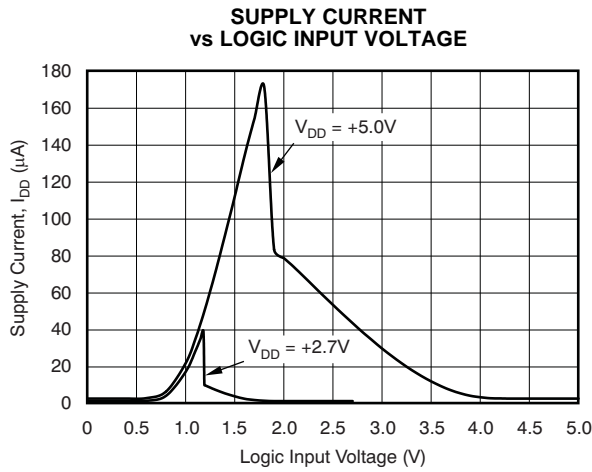

Figure 34.

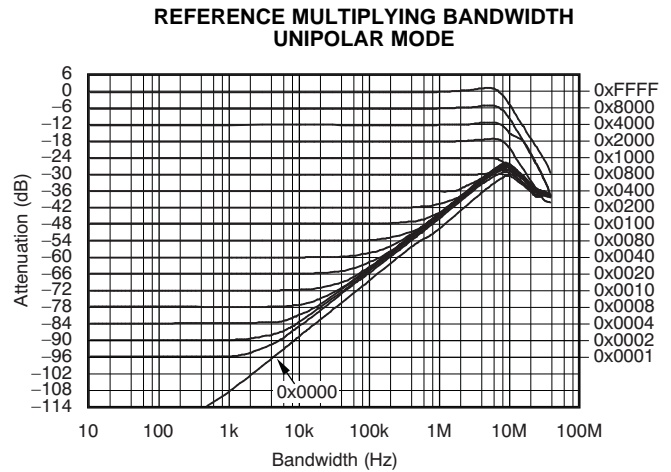

Figure 35.

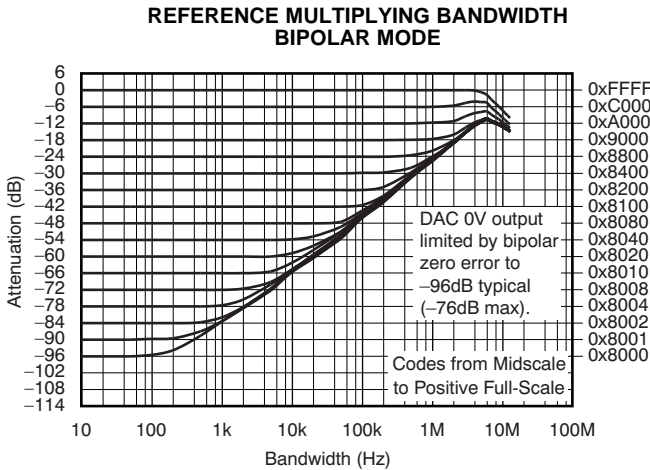

Figure 36.

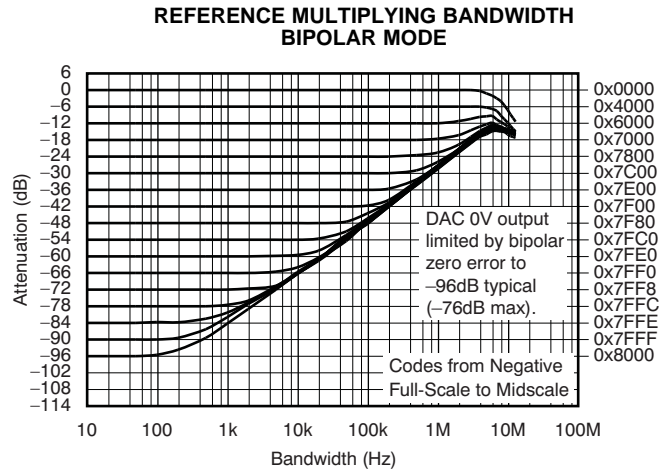

Figure 37.

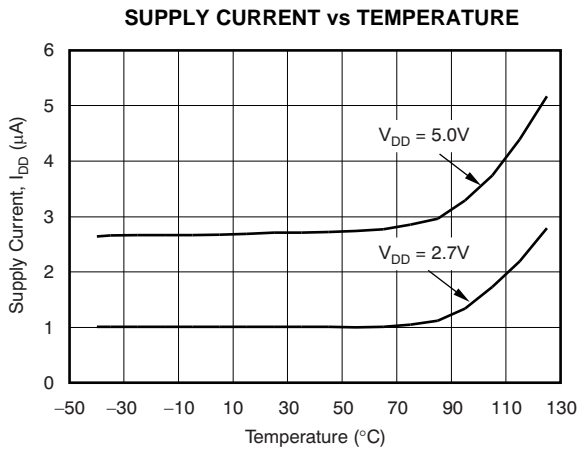

Figure 38.

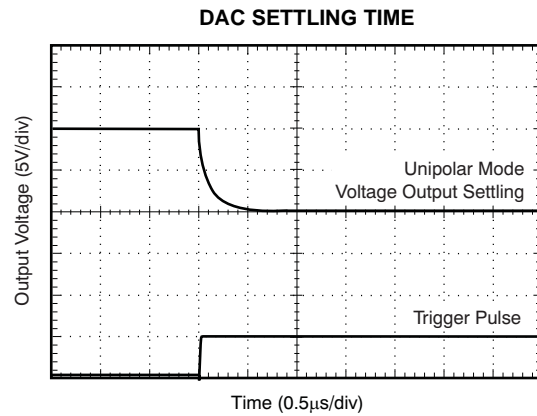

Figure 39.

THEORY OF OPERATION

The DAC8822 is a multiplying, dual-channel, current output, 16-bit DAC. The architecture, illustrated in Figure 40, is an R-2R ladder configuration with the three MSBs segmented. Each 2R leg of the ladder is either switched to GND or to the I_{OUT} terminal. The I_{OUT} terminal of the DAC is held at a virtual GND potential by the use of an external I/V converter op amp. The R-2R ladder is connected to an external reference input (V_{REF}) that determines the DAC full-scale output current. The R-2R ladder presents a code-independent load impedance to the external reference of $5k\Omega \pm 25\%$. The external reference voltage can vary in a range of $-18V$ to $+18V$, thus providing bipolar I_{OUT} current operation. By using an external I/V converter op amp and the R_{FB} resistor in the DAC8822, an output voltage range of $-V_{REF}$ to $+V_{REF}$ can be generated.

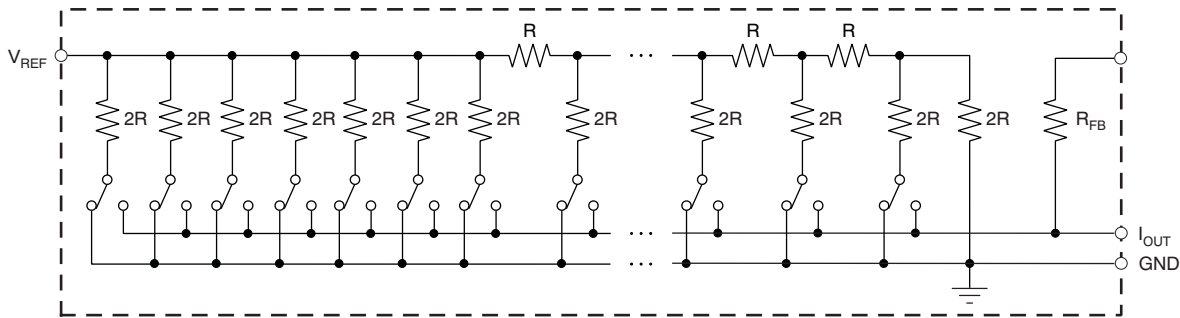

Figure 40. Equivalent R-2R DAC Circuit

The DAC output voltage is determined by V_{REF} and the digital data (D) according to Equation 1:

$$V_{OUT\ A/B} = -V_{REF} \times \frac{D}{65536} \quad (1)$$

Each DAC code determines the 2R-leg switch position to either GND or I_{OUT} . The external I/V converter op amp noise gain will also change because the DAC output impedance (as seen looking into the I_{OUT} terminal) changes versus code. Because of this change in noise gain, the external I/V converter op amp must have a sufficiently low offset voltage such that the amplifier offset is not modulated by the DAC I_{OUT} terminal impedance change. External op amps with large offset voltages can produce INL errors in the transfer function of the DAC8822 because of offset modulation versus DAC code. For best linearity performance of the DAC8822, an op amp (such as the OPA277) is recommended, as shown in Figure 41. This circuit allows V_{REF} to swing from $-10V$ to $+10V$.

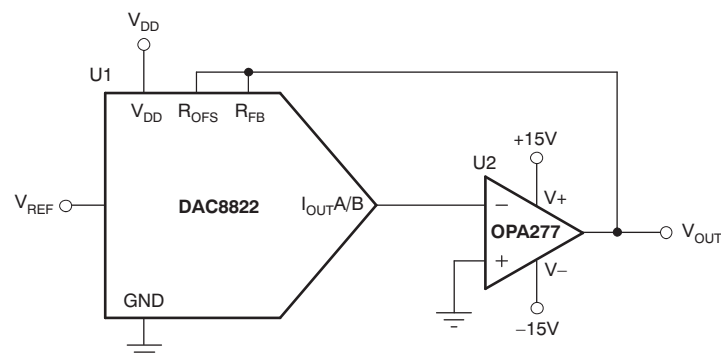

Figure 41. Voltage Output Configuration

APPLICATION INFORMATION

DIGITAL INTERFACE

The parallel bus interface of the DAC8822 is comprised of a 16-bit data bus D0—D15, address lines A0 and A1, and a \overline{WR} control signal. Timing and control functionality are shown in [Figure 1](#), and described in [Table 2](#) and [Table 3](#). The address lines must be set up and stable before the \overline{WR} signal goes low, to prevent loading improper data to an undesired input register.

Both channels of the DAC8822 can be simultaneously updated by control of the LDAC signal, as shown in [Figure 1](#). Reset control (\overline{RS}) and reset select control (RSTSEL) signals are provided to allow user reset ability to either zero scale or midscale codes of both the input and DAC registers.

STABILITY CIRCUIT

For a current-to-voltage (I/V) design, as shown in [Figure 42](#), the DAC8822 current output (I_{OUT}) and the connection with the inverting node of the op amp should be as short as possible and laid out according to correct printed circuit board (PCB) layout design. For each code change, there is an output step function. If the gain bandwidth product (GBP) of the op amp is limited and parasitic capacitance is excessive at the inverting node, then gain peaking is possible. Therefore, a compensation capacitor C_1 (4pF to 20pF, typ) can be added to the design for circuit stability, as shown in [Figure 42](#).

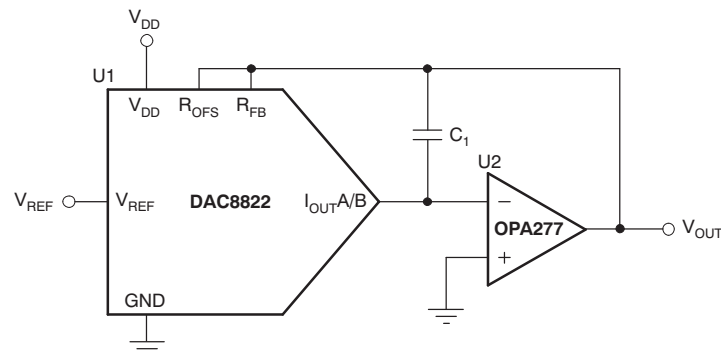

Figure 42. Gain Peaking Prevention Circuit with Compensation Capacitor

APPLICATION INFORMATION (continued)

BIPOLAR OUTPUT CIRCUIT

The DAC8822, as a 4-quadrant multiplying DAC, can be used to generate a bipolar output. The polarity of the full-scale output (I_{OUT}) is the inverse of the input reference voltage at V_{REF} .

Using a dual op amp, such as the [OPA2277](#), full 4-quadrant operation can be achieved with minimal components. [Figure 43](#) demonstrates a $\pm 10V_{OUT}$ circuit with a fixed +10V reference. The output voltage is shown in [Equation 2](#):

$$V_{OUT} = \left(\frac{D}{32768} - 1 \right) \times V_{REF} \tag{2}$$

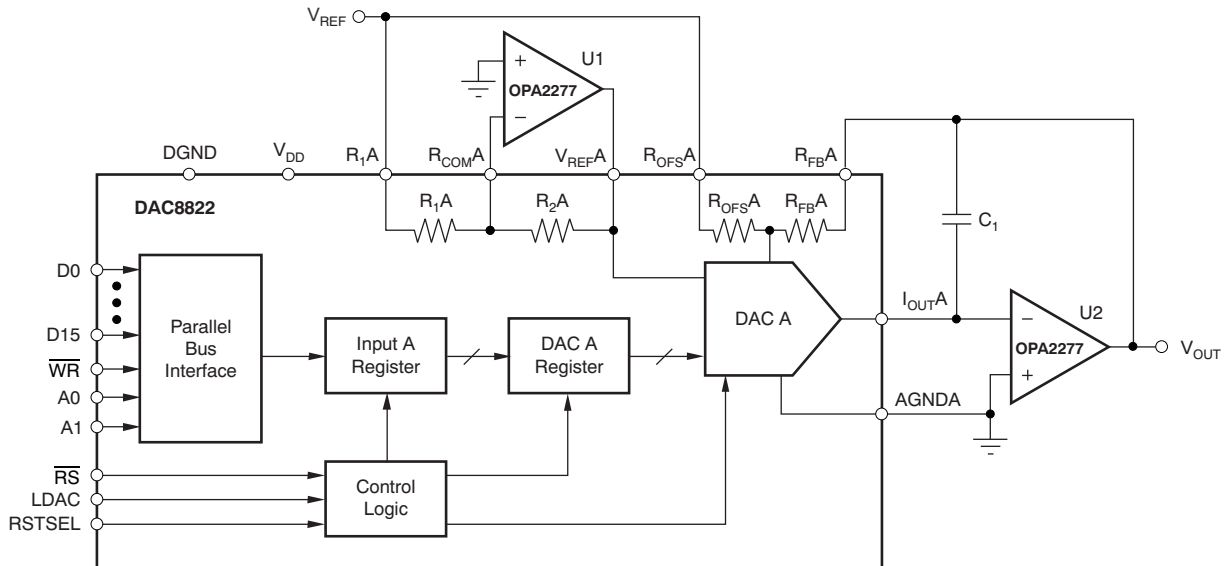

Figure 43. Bipolar Output Circuit for Channel A

APPLICATION INFORMATION (continued)

PROGRAMMABLE CURRENT SOURCE CIRCUIT

The DAC8822 can be integrated into the circuit in [Figure 44](#) to implement an improved Howland current pump for precise V/I conversions. Bidirectional current flow and high-voltage compliance are two features of the circuit. With a matched resistor network, the load current of the circuit is shown by [Equation 3](#):

$$I_{L\ A/B} = \frac{(R_2 + R_3) / R_1}{R_3} \times V_{REF} \times \frac{D}{65536} \tag{3}$$

The value of R_3 in the previous equation can be reduced to increase the output current drive of U3. U3 can drive $\pm 20\text{mA}$ in both directions with voltage compliance limited up to 15V by the U3 voltage supply. Elimination of the circuit compensation capacitor (C_1) in the circuit is not suggested as a result of the change in the output impedance (Z_O), according to [Equation 4](#):

$$Z_O = \frac{R_1' R_3 (R_1 + R_2)}{R_1 (R_2' + R_3') - R_1' (R_2 + R_3)} \tag{4}$$

As shown in [Equation 4](#), Z_O with matched resistors is infinite and the circuit is optimum for use as a current source. However, if unmatched resistors are used, Z_O is positive or negative with negative output impedance being a potential cause of oscillation. Therefore, by incorporating C_1 into the circuit, possible oscillation problems are eliminated. The value of C_1 can be determined for critical applications; for most applications, however, a value of several pF is suggested.

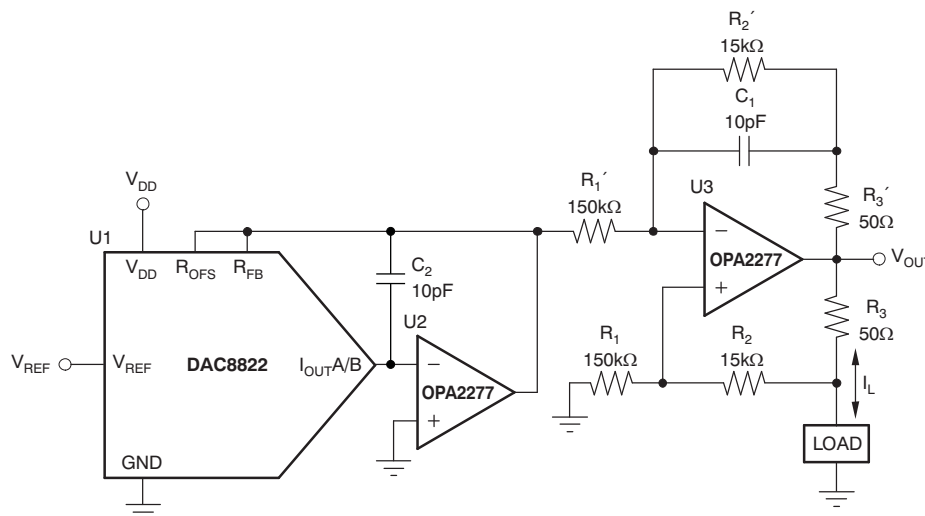

Figure 44. Programmable Bidirectional Current Source Circuit

CROSS-REFERENCE

The DAC8822 has an industry-standard pinout. [Table 4](#) provides the cross-reference information.

Table 4. Cross-Reference

PRODUCT	BIT	INL (LSB)	DNL (LSB)	SPECIFIED TEMPERATURE RANGE	PACKAGE DESCRIPTION	PACKAGE OPTION	CROSS-REFERENCE PART
DAC8822QB	16	2	1	-40°C to +125°C	TSSOP-38	DBT	AD5547B
DAC8822QC	16	1	1	-40°C to +125°C	TSSOP-38	DBT	N/A

PACKAGING INFORMATION

Orderable Device	Status ⁽¹⁾	Package Type	Package Drawing	Pins	Package Qty	Eco Plan ⁽²⁾	Lead/ Ball Finish	MSL Peak Temp ⁽³⁾	Samples (Requires Login)
DAC8822QBDBT	ACTIVE	TSSOP	DBT	38	50	Green (RoHS & no Sb/Br)	CU NIPDAU	Level-2-260C-1 YEAR	
DAC8822QBDBTG4	ACTIVE	TSSOP	DBT	38	50	Green (RoHS & no Sb/Br)	CU NIPDAU	Level-2-260C-1 YEAR	
DAC8822QBDBTR	ACTIVE	TSSOP	DBT	38	2000	Green (RoHS & no Sb/Br)	CU NIPDAU	Level-2-260C-1 YEAR	
DAC8822QBDBTRG4	ACTIVE	TSSOP	DBT	38	2000	Green (RoHS & no Sb/Br)	CU NIPDAU	Level-2-260C-1 YEAR	
DAC8822QCDBT	ACTIVE	TSSOP	DBT	38	50	Green (RoHS & no Sb/Br)	CU NIPDAU	Level-2-260C-1 YEAR	
DAC8822QCDBTG4	ACTIVE	TSSOP	DBT	38	50	Green (RoHS & no Sb/Br)	CU NIPDAU	Level-2-260C-1 YEAR	
DAC8822QCDBTR	ACTIVE	TSSOP	DBT	38	2000	Green (RoHS & no Sb/Br)	CU NIPDAU	Level-2-260C-1 YEAR	
DAC8822QCDBTRG4	ACTIVE	TSSOP	DBT	38	2000	Green (RoHS & no Sb/Br)	CU NIPDAU	Level-2-260C-1 YEAR	

⁽¹⁾ The marketing status values are defined as follows:

ACTIVE: Product device recommended for new designs.

LIFEBUY: TI has announced that the device will be discontinued, and a lifetime-buy period is in effect.

NRND: Not recommended for new designs. Device is in production to support existing customers, but TI does not recommend using this part in a new design.

PREVIEW: Device has been announced but is not in production. Samples may or may not be available.

OBSOLETE: TI has discontinued the production of the device.

⁽²⁾ Eco Plan - The planned eco-friendly classification: Pb-Free (RoHS), Pb-Free (RoHS Exempt), or Green (RoHS & no Sb/Br) - please check <http://www.ti.com/productcontent> for the latest availability information and additional product content details.

TBD: The Pb-Free/Green conversion plan has not been defined.

Pb-Free (RoHS): TI's terms "Lead-Free" or "Pb-Free" mean semiconductor products that are compatible with the current RoHS requirements for all 6 substances, including the requirement that lead not exceed 0.1% by weight in homogeneous materials. Where designed to be soldered at high temperatures, TI Pb-Free products are suitable for use in specified lead-free processes.

Pb-Free (RoHS Exempt): This component has a RoHS exemption for either 1) lead-based flip-chip solder bumps used between the die and package, or 2) lead-based die adhesive used between the die and leadframe. The component is otherwise considered Pb-Free (RoHS compatible) as defined above.

Green (RoHS & no Sb/Br): TI defines "Green" to mean Pb-Free (RoHS compatible), and free of Bromine (Br) and Antimony (Sb) based flame retardants (Br or Sb do not exceed 0.1% by weight in homogeneous material)

⁽³⁾ MSL, Peak Temp. -- The Moisture Sensitivity Level rating according to the JEDEC industry standard classifications, and peak solder temperature.

Important Information and Disclaimer: The information provided on this page represents TI's knowledge and belief as of the date that it is provided. TI bases its knowledge and belief on information provided by third parties, and makes no representation or warranty as to the accuracy of such information. Efforts are underway to better integrate information from third parties. TI has taken and continues to take reasonable steps to provide representative and accurate information but may not have conducted destructive testing or chemical analysis on incoming materials and chemicals. TI and TI suppliers consider certain information to be proprietary, and thus CAS numbers and other limited information may not be available for release.

In no event shall TI's liability arising out of such information exceed the total purchase price of the TI part(s) at issue in this document sold by TI to Customer on an annual basis.

TAPE AND REEL INFORMATION
REEL DIMENSIONS

TAPE DIMENSIONS

A0	Dimension designed to accommodate the component width
B0	Dimension designed to accommodate the component length
K0	Dimension designed to accommodate the component thickness
W	Overall width of the carrier tape
P1	Pitch between successive cavity centers

TAPE AND REEL INFORMATION

*All dimensions are nominal

Device	Package Type	Package Drawing	Pins	SPQ	Reel Diameter (mm)	Reel Width W1 (mm)	A0 (mm)	B0 (mm)	K0 (mm)	P1 (mm)	W (mm)	Pin1 Quadrant
DAC8822QBDBTR	TSSOP	DBT	38	2000	330.0	16.4	6.9	10.2	1.8	12.0	16.0	Q1
DAC8822QCDBTR	TSSOP	DBT	38	2000	330.0	16.4	6.9	10.2	1.8	12.0	16.0	Q1

TAPE AND REEL BOX DIMENSIONS



*All dimensions are nominal

Device	Package Type	Package Drawing	Pins	SPQ	Length (mm)	Width (mm)	Height (mm)
DAC8822QBDBTR	TSSOP	DBT	38	2000	367.0	367.0	38.0
DAC8822QCDBTR	TSSOP	DBT	38	2000	367.0	367.0	38.0

MECHANICAL DATA

DBT (R-PDSO-G38)

PLASTIC SMALL OUTLINE

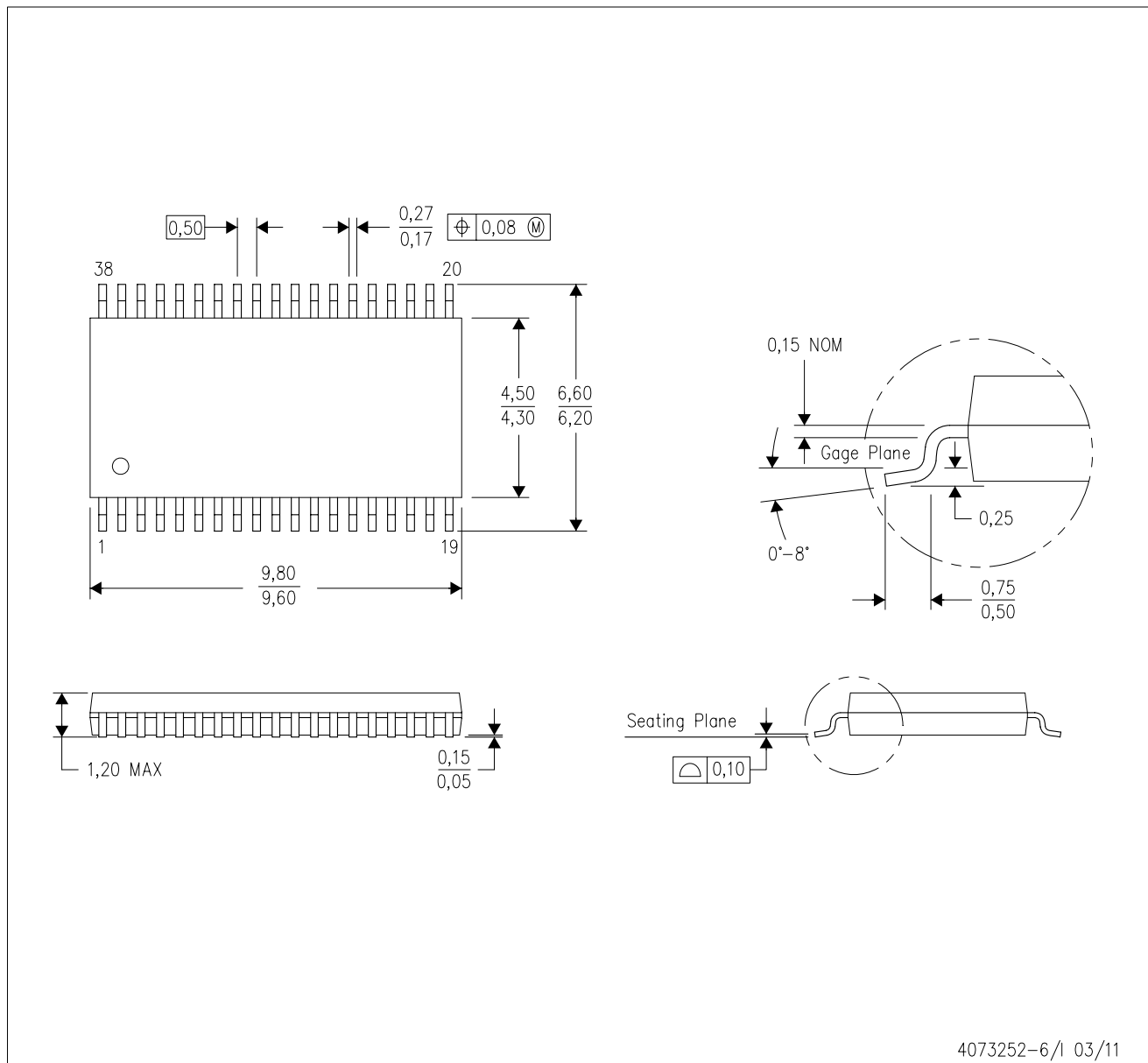

- NOTES:
- All linear dimensions are in millimeters. Dimensioning and tolerancing per ASME Y14.5M-1994.
 - This drawing is subject to change without notice.
 - Body dimensions do not include mold flash or protrusion.
 - Falls within JEDEC MO-153.

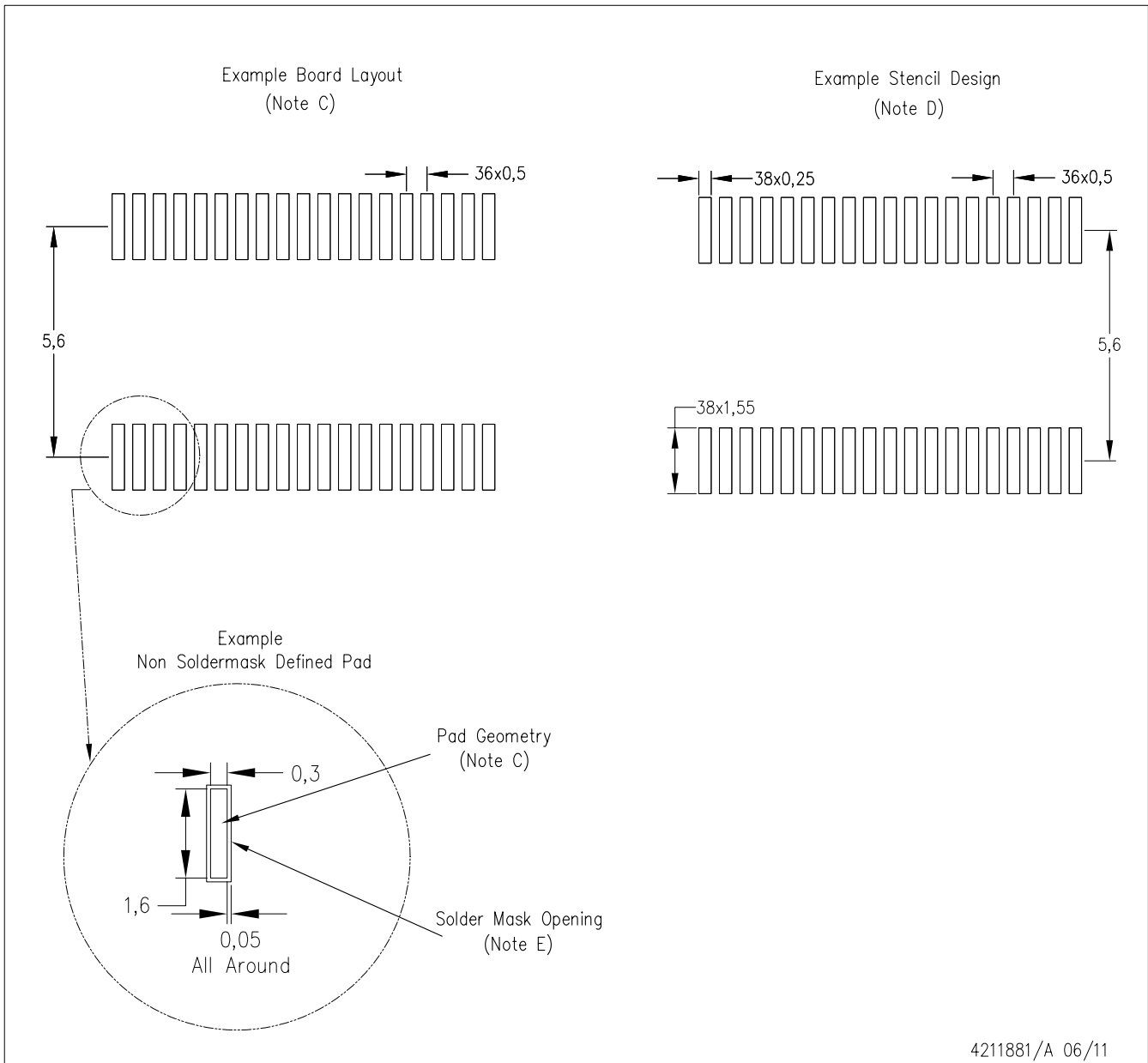

- NOTES:
- A. All linear dimensions are in millimeters.
 - B. This drawing is subject to change without notice.
 - C. Publication IPC-7351 is recommended for alternate designs.
 - D. Laser cutting apertures with trapezoidal walls and also rounding corners will offer better paste release. Customers should contact their board assembly site for stencil design recommendations. Refer to IPC-7525.
 - E. Customers should contact their board fabrication site for solder mask tolerances between and around signal pads.

IMPORTANT NOTICE

Texas Instruments Incorporated and its subsidiaries (TI) reserve the right to make corrections, enhancements, improvements and other changes to its semiconductor products and services per JESD46C and to discontinue any product or service per JESD48B. Buyers should obtain the latest relevant information before placing orders and should verify that such information is current and complete. All semiconductor products (also referred to herein as "components") are sold subject to TI's terms and conditions of sale supplied at the time of order acknowledgment.

TI warrants performance of its components to the specifications applicable at the time of sale, in accordance with the warranty in TI's terms and conditions of sale of semiconductor products. Testing and other quality control techniques are used to the extent TI deems necessary to support this warranty. Except where mandated by applicable law, testing of all parameters of each component is not necessarily performed.

TI assumes no liability for applications assistance or the design of Buyers' products. Buyers are responsible for their products and applications using TI components. To minimize the risks associated with Buyers' products and applications, Buyers should provide adequate design and operating safeguards.

TI does not warrant or represent that any license, either express or implied, is granted under any patent right, copyright, mask work right, or other intellectual property right relating to any combination, machine, or process in which TI components or services are used. Information published by TI regarding third-party products or services does not constitute a license to use such products or services or a warranty or endorsement thereof. Use of such information may require a license from a third party under the patents or other intellectual property of the third party, or a license from TI under the patents or other intellectual property of TI.

Reproduction of significant portions of TI information in TI data books or data sheets is permissible only if reproduction is without alteration and is accompanied by all associated warranties, conditions, limitations, and notices. TI is not responsible or liable for such altered documentation. Information of third parties may be subject to additional restrictions.

Resale of TI components or services with statements different from or beyond the parameters stated by TI for that component or service voids all express and any implied warranties for the associated TI component or service and is an unfair and deceptive business practice. TI is not responsible or liable for any such statements.

Buyer acknowledges and agrees that it is solely responsible for compliance with all legal, regulatory and safety-related requirements concerning its products, and any use of TI components in its applications, notwithstanding any applications-related information or support that may be provided by TI. Buyer represents and agrees that it has all the necessary expertise to create and implement safeguards which anticipate dangerous consequences of failures, monitor failures and their consequences, lessen the likelihood of failures that might cause harm and take appropriate remedial actions. Buyer will fully indemnify TI and its representatives against any damages arising out of the use of any TI components in safety-critical applications.

In some cases, TI components may be promoted specifically to facilitate safety-related applications. With such components, TI's goal is to help enable customers to design and create their own end-product solutions that meet applicable functional safety standards and requirements. Nonetheless, such components are subject to these terms.

No TI components are authorized for use in FDA Class III (or similar life-critical medical equipment) unless authorized officers of the parties have executed a special agreement specifically governing such use.

Only those TI components which TI has specifically designated as military grade or "enhanced plastic" are designed and intended for use in military/aerospace applications or environments. Buyer acknowledges and agrees that any military or aerospace use of TI components which have **not** been so designated is solely at the Buyer's risk, and that Buyer is solely responsible for compliance with all legal and regulatory requirements in connection with such use.

TI has specifically designated certain components which meet ISO/TS16949 requirements, mainly for automotive use. Components which have not been so designated are neither designed nor intended for automotive use; and TI will not be responsible for any failure of such components to meet such requirements.

Products

Audio	www.ti.com/audio
Amplifiers	amplifier.ti.com
Data Converters	dataconverter.ti.com
DLP® Products	www.dlp.com
DSP	dsp.ti.com
Clocks and Timers	www.ti.com/clocks
Interface	interface.ti.com
Logic	logic.ti.com
Power Mgmt	power.ti.com
Microcontrollers	microcontroller.ti.com
RFID	www.ti-rfid.com
OMAP Mobile Processors	www.ti.com/omap
Wireless Connectivity	www.ti.com/wirelessconnectivity

Applications

Automotive and Transportation	www.ti.com/automotive
Communications and Telecom	www.ti.com/communications
Computers and Peripherals	www.ti.com/computers
Consumer Electronics	www.ti.com/consumer-apps
Energy and Lighting	www.ti.com/energy
Industrial	www.ti.com/industrial
Medical	www.ti.com/medical
Security	www.ti.com/security
Space, Avionics and Defense	www.ti.com/space-avionics-defense
Video and Imaging	www.ti.com/video

TI E2E Community e2e.ti.com