

## Features

- Very high speed: 45 ns
  - Wide voltage range: 4.5 V–5.5 V
- Ultra low active power
  - Typical active current: 1.8 mA at  $f = 1$  MHz
  - Typical active current: 18 mA at  $f = f_{max}$
- Ultra low standby power
  - Typical standby current: 2  $\mu$ A
  - Maximum standby current: 8  $\mu$ A
- Easy memory expansion with  $\overline{CE}_1$ ,  $CE_2$  and  $\overline{OE}$  features
- Automatic power down when deselected
- CMOS for optimum speed and power
- Offered in Pb-free 44-pin TSOP II package

## Functional Description

The CY62158E MoBL<sup>®</sup> is a high performance CMOS static RAM organized as 1024K words by 8 bits. This device features

advanced circuit design to provide ultra low active current. This is ideal for providing More Battery Life<sup>™</sup> (MoBL<sup>®</sup>) in portable applications such as cellular telephones. The device also has an automatic power down feature that significantly reduces power consumption. Placing the device into standby mode reduces power consumption significantly when deselected ( $\overline{CE}_1$  HIGH or  $CE_2$  LOW).

To write to the device, take Chip Enables ( $\overline{CE}_1$  LOW and  $CE_2$  HIGH) and Write Enable ( $\overline{WE}$ ) input LOW. Data on the eight I/O pins ( $I/O_0$  through  $I/O_7$ ) is then written into the location specified on the address pins ( $A_0$  through  $A_{19}$ ).

To read from the device, take Chip Enables ( $\overline{CE}_1$  LOW and  $CE_2$  HIGH) and  $\overline{OE}$  LOW while forcing the  $\overline{WE}$  HIGH. Under these conditions, the contents of the memory location specified by the address pins appear on the I/O pins.

The eight input and output pins ( $I/O_0$  through  $I/O_7$ ) are placed in a high impedance state when the device is deselected ( $\overline{CE}_1$  HIGH or  $CE_2$  LOW), the outputs are disabled ( $\overline{OE}$  HIGH), or a write operation is in progress ( $\overline{CE}_1$  LOW and  $CE_2$  HIGH and  $\overline{WE}$  LOW). See the Truth Table on page 11 for a complete description of read and write modes.

## Logic Block Diagram

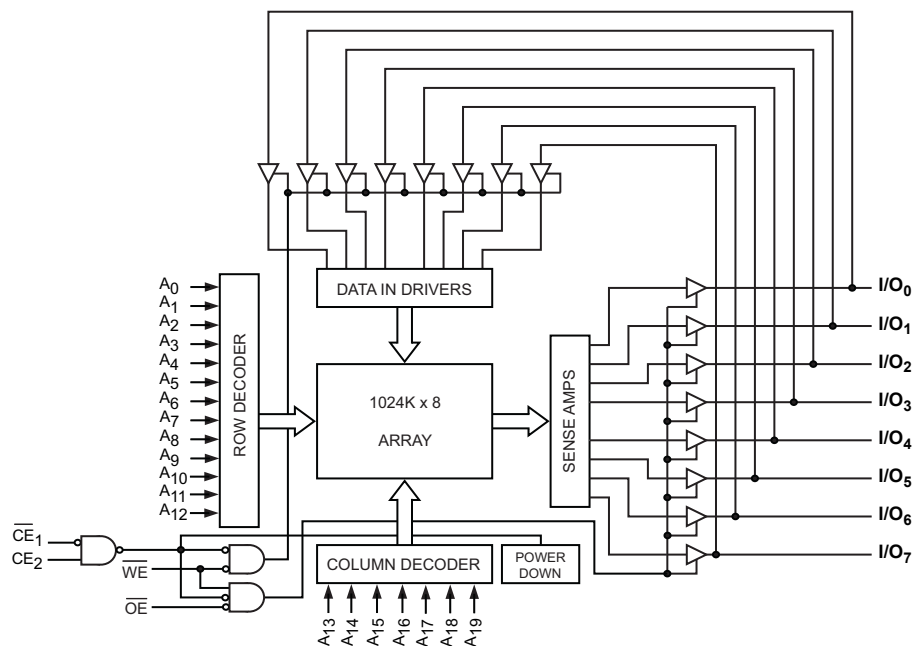

## Contents

<b>Pin Configuration</b> .....	<b>3</b>	<b>Truth Table</b> .....	<b>11</b>
<b>Product Portfolio</b> .....	<b>3</b>	<b>Ordering Information</b> .....	<b>12</b>
<b>Maximum Ratings</b> .....	<b>4</b>	Ordering Code Definitions .....	12
<b>Operating Range</b> .....	<b>4</b>	<b>Package Diagrams</b> .....	<b>13</b>
<b>Electrical Characteristics</b> .....	<b>4</b>	<b>Acronyms</b> .....	<b>14</b>
<b>Capacitance</b> .....	<b>5</b>	<b>Document Conventions</b> .....	<b>14</b>
<b>Thermal Resistance</b> .....	<b>5</b>	Units of Measure .....	14
<b>AC Test Loads and Waveforms</b> .....	<b>5</b>	<b>Document History Page</b> .....	<b>15</b>
<b>Data Retention Characteristics</b> .....	<b>6</b>	<b>Sales, Solutions, and Legal Information</b> .....	<b>16</b>
<b>Data Retention Waveform</b> .....	<b>6</b>	Worldwide Sales and Design Support .....	16
<b>Switching Characteristics</b> .....	<b>7</b>	Products .....	16
<b>Switching Waveforms</b> .....	<b>8</b>	PSoC Solutions .....	16

## Pin Configuration

Figure 1. 44-pin TSOP II (Top View)<sup>[1]</sup>

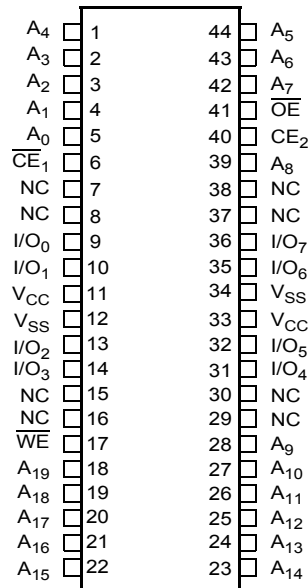

## Product Portfolio

Product	V <sub>CC</sub> Range (V)			Speed (ns)	Power Dissipation					
					Operating I <sub>CC</sub> (mA)				Standby I <sub>SB2</sub> (μA)	
					f = 1 MHz		f = f <sub>max</sub>			
Min	Typ <sup>[2]</sup>	Max		Typ <sup>[2]</sup>	Max	Typ <sup>[2]</sup>	Max	Typ <sup>[2]</sup>	Max	
CY62158ELL	4.5	5.0	5.5	45	1.8	3	18	25	2	8

### Notes

1. NC pins are not connected on the die.
2. Typical values are included for reference only and are not guaranteed or tested. Typical values are measured at V<sub>CC</sub> = V<sub>CC(typ)</sub>, T<sub>A</sub> = 25 °C.

## Maximum Ratings

Exceeding maximum ratings may shorten the useful life of the device. User guidelines are not tested.

Storage Temperature .....	-65 °C to +150 °C
Ambient Temperature with Power Applied .....	-55 °C to +125 °C
Supply Voltage to Ground Potential .....	-0.5 V to $V_{CC(max)}$ + 0.5 V
DC Voltage Applied to Outputs in High Z State <sup>[3, 4]</sup> .....	-0.5 V to $V_{CC(max)}$ + 0.5 V

DC Input Voltage <sup>[3, 4]</sup> .....	-0.5 V to $V_{CC(max)}$ + 0.5 V
Output Current into Outputs (LOW) .....	20 mA
Static Discharge Voltage .....	> 2001 V (MIL-STD-883, Method 3015)
Latch up Current .....	> 200 mA

## Operating Range

Device	Range	Ambient Temperature	$V_{CC}$ <sup>[5]</sup>
CY62158ELL	Industrial	-40 °C to +85 °C	4.5 V–5.5 V

## Electrical Characteristics

Over the Operating Range

Parameter	Description	Test Conditions	-45			Unit
			Min	Typ <sup>[6]</sup>	Max	
$V_{OH}$	Output HIGH Voltage	$I_{OH} = -1$ mA	2.4	–	–	V
$V_{OL}$	Output LOW Voltage	$I_{OL} = 2.1$ mA	–	–	0.4	V
$V_{IH}$	Input HIGH Voltage	$V_{CC} = 4.5$ V to 5.5 V	2.2	–	$V_{CC} + 0.5$ V	V
$V_{IL}$	Input LOW Voltage	$V_{CC} = 4.5$ V to 5.5 V	-0.5	–	0.8	V
$I_{IX}$	Input Leakage Current	$GND \leq V_I \leq V_{CC}$	-1	–	+1	μA
$I_{OZ}$	Output Leakage Current	$GND \leq V_O \leq V_{CC}$ , Output Disabled	-1	–	+1	μA
$I_{CC}$	$V_{CC}$ Operating Supply Current	$f = f_{MAX} = 1/t_{RC}$	–	18	25	mA
		$f = 1$ MHz		1.8	3	mA
$I_{SB1}$	Automatic CE Power down Current — CMOS Inputs	$CE_1 \geq V_{CC} - 0.2$ V, $CE_2 \leq 0.2$ V	–	2	8	μA
		$V_{IN} \geq V_{CC} - 0.2$ V, $V_{IN} \leq 0.2$ V				
$I_{SB2}$ <sup>[7]</sup>	Automatic CE Power-down Current — CMOS Inputs	$CE_1 \geq V_{CC} - 0.2$ V or $CE_2 \leq 0.2$ V,	–	2	8	μA
		$V_{IN} \geq V_{CC} - 0.2$ V or $V_{IN} \leq 0.2$ V, $f = 0$ , $V_{CC} = V_{CCmax}$				

### Notes

- $V_{IL}(min) = -2.0$  V for pulse durations less than 20 ns.
- $V_{IH}(max) = V_{CC} + 0.75$  V for pulse durations less than 20 ns.
- Full Device AC operation assumes a 100 μs ramp time from 0 to  $V_{CC}(min)$  and 200 μs wait time after  $V_{CC}$  stabilization.
- Typical values are included for reference only and are not guaranteed or tested. Typical values are measured at  $V_{CC} = V_{CC(typ)}$ ,  $T_A = 25$  °C.
- Chip enables ( $CE_1$  and  $CE_2$ ), must be tied to CMOS levels to meet the  $I_{SB1}$  /  $I_{SB2}$  /  $I_{CCDR}$  spec. Other inputs can be left floating.

### Capacitance

Parameter <sup>[8]</sup>	Description	Test Conditions	Max	Unit
C <sub>IN</sub>	Input Capacitance	T <sub>A</sub> = 25 °C, f = 1 MHz, V <sub>CC</sub> = V <sub>CC(typ)</sub>	10	pF
C <sub>OUT</sub>	Output Capacitance		10	pF

### Thermal Resistance

Parameter <sup>[8]</sup>	Description	Test Conditions	44-pin TSOP II	Unit
Θ <sub>JA</sub>	Thermal Resistance (Junction to Ambient)	Still Air, soldered on a 3 × 4.5 inch, two-layer printed circuit board	75.13	°C/W
Θ <sub>JC</sub>	Thermal Resistance (Junction to Case)		8.95	°C/W

### AC Test Loads and Waveforms

Figure 2. AC Test Loads and Waveforms

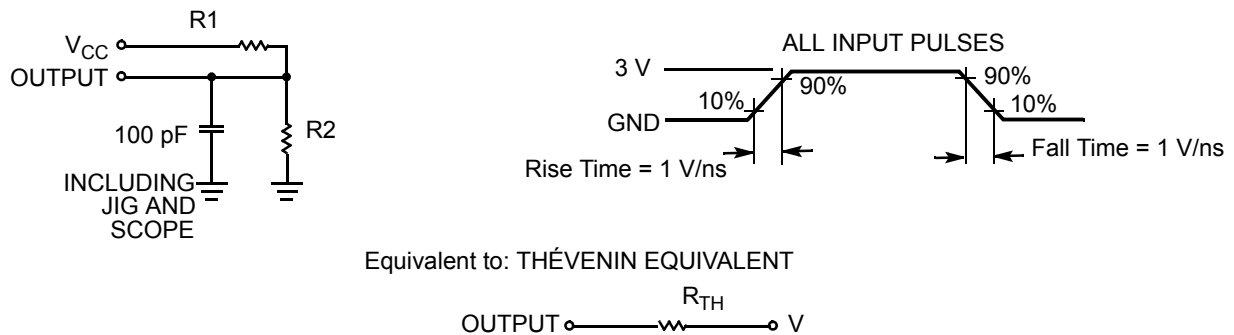

Parameters	5.0 V	Unit
R1	1838	Ω
R2	994	Ω
R <sub>TH</sub>	645	Ω
V <sub>TH</sub>	1.75	V

**Note**

8. Tested initially and after any design or process changes that may affect these parameters.

## Data Retention Characteristics

Over the Operating Range

Parameter	Description	Conditions	Min	Typ <sup>[9]</sup>	Max	Unit
$V_{DR}$	$V_{CC}$ for Data Retention		2	–	–	V
$I_{CCDR}$ <sup>[10]</sup>	Data Retention Current	$V_{CC} = V_{DR}$ $CE_1 \geq V_{CC} - 0.2\text{ V}$ , $CE_2 \leq 0.2\text{ V}$ , $V_{IN} \geq V_{CC} - 0.2\text{ V}$ or $V_{IN} \leq 0.2\text{ V}$	–	–	8	$\mu\text{A}$
$t_{CDR}$ <sup>[11]</sup>	Chip Deselect to Data Retention Time		0	–	–	ns
$t_R$ <sup>[12]</sup>	Operation Recovery Time		45	–	–	ns

## Data Retention Waveform

Figure 3. Data Retention Waveform

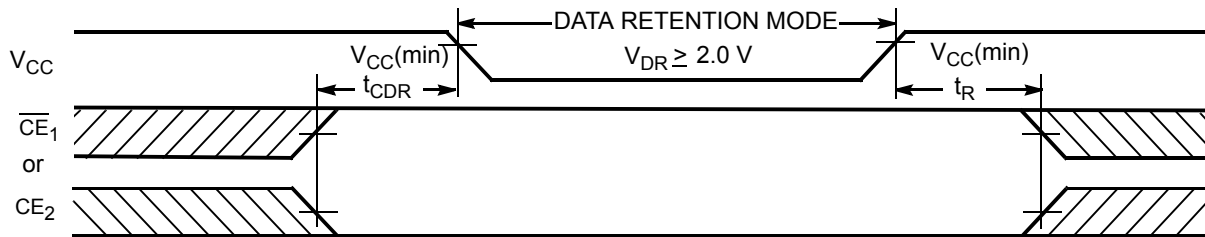

### Notes

9. Typical values are included for reference only and are not guaranteed or tested. Typical values are measured at  $V_{CC} = V_{CC(\text{typ})}$ ,  $T_A = 25\text{ }^\circ\text{C}$ .
10. Chip enables ( $CE_1$  and  $CE_2$ ), must be tied to CMOS levels to meet the  $I_{SB1}$  /  $I_{SB2}$  /  $I_{CCDR}$  spec. Other inputs can be left floating.
11. Tested initially and after any design or process changes that may affect these parameters.
12. Full device operation requires linear  $V_{CC}$  ramp from  $V_{DR}$  to  $V_{CC(\text{min})} \geq 100\text{ }\mu\text{s}$  or stable at  $V_{CC(\text{min})} \geq 100\text{ }\mu\text{s}$ .

## Switching Characteristics

Over the Operating Range

Parameter <sup>[13]</sup>	Description	45 ns		Unit
		Min	Max	
<b>Read Cycle</b>				
$t_{RC}$	Read Cycle Time	45	–	ns
$t_{AA}$	Address to Data Valid	–	45	ns
$t_{OHA}$	Data Hold from Address Change	10	–	ns
$t_{ACE}$	$\overline{CE}_1$ LOW and $CE_2$ HIGH to Data Valid	–	45	ns
$t_{DOE}$	$\overline{OE}$ LOW to Data Valid	–	22	ns
$t_{LZOE}$	$\overline{OE}$ LOW to Low Z <sup>[14]</sup>	5	–	ns
$t_{HZOE}$	$\overline{OE}$ HIGH to High Z <sup>[14, 15]</sup>	–	18	ns
$t_{LZCE}$	$\overline{CE}_1$ LOW and $CE_2$ HIGH to Low Z <sup>[14]</sup>	10	–	ns
$t_{HZCE}$	$\overline{CE}_1$ HIGH or $CE_2$ LOW to High Z <sup>[14, 15]</sup>	–	18	ns
$t_{PU}$	$\overline{CE}_1$ LOW and $CE_2$ HIGH to Power Up	0	–	ns
$t_{PD}$	$\overline{CE}_1$ HIGH or $CE_2$ LOW to Power Down	–	45	ns
<b>Write Cycle <sup>[16]</sup></b>				
$t_{WC}$	Write Cycle Time	45	–	ns
$t_{SCE}$	$\overline{CE}_1$ LOW and $CE_2$ HIGH to Write End	35	–	ns
$t_{AW}$	Address Setup to Write End	35	–	ns
$t_{HA}$	Address Hold from Write End	0	–	ns
$t_{SA}$	Address Setup to Write Start	0	–	ns
$t_{PWE}$	$\overline{WE}$ Pulse Width	35	–	ns
$t_{SD}$	Data Setup to Write End	25	–	ns
$t_{HD}$	Data Hold from Write End	0	–	ns
$t_{HZWE}$	$\overline{WE}$ LOW to High Z <sup>[14, 15]</sup>	–	18	ns
$t_{LZWE}$	$\overline{WE}$ HIGH to Low Z <sup>[14]</sup>	10	–	ns

### Notes

13. Test conditions for all parameters other than tri-state parameters assume signal transition time of 3 ns or less (1 V/ns), timing reference levels of  $V_{CC(typ)}/2$ , input pulse levels of 0 to  $V_{CC(typ)}$ , and output loading of the specified  $I_{OL}/I_{OH}$  as shown in [Figure 2 on page 5](#).
14. At any given temperature and voltage condition,  $t_{HZCE}$  is less than  $t_{LZCE}$ ,  $t_{HZOE}$  is less than  $t_{LZOE}$ , and  $t_{HZWE}$  is less than  $t_{LZWE}$  for any given device.
15.  $t_{HZOE}$ ,  $t_{HZCE}$ , and  $t_{HZWE}$  transitions are measured when the outputs enter a high impedance state.
16. The internal write time of the memory is defined by the overlap of  $\overline{WE}$ ,  $\overline{CE}_1 = V_{IL}$ , and  $CE_2 = V_{IH}$ . All signals must be ACTIVE to initiate a write and any of these signals can terminate a write by going INACTIVE. The data input setup and hold timing should be referenced to the edge of the signal that terminates the write.

## Switching Waveforms

Figure 4. Read Cycle No. 1 (Address Transition Controlled) [17, 18]

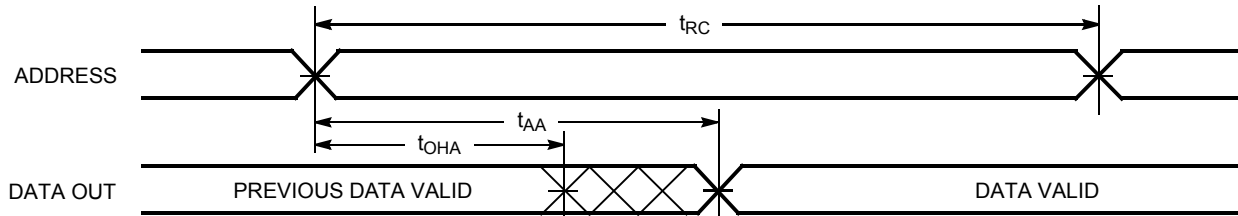
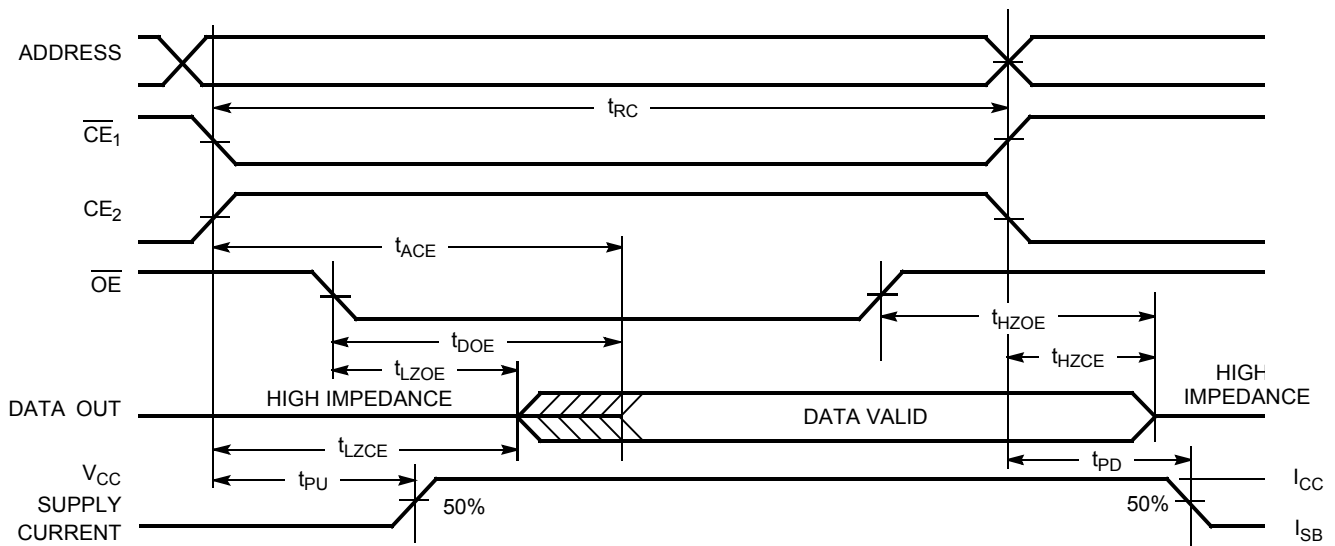

Figure 5. Read Cycle No. 2 ( $\overline{OE}$  Controlled) [18, 19]



### Notes

17. Device is continuously selected.  $\overline{OE}$ ,  $\overline{CE}_1 = V_{IL}$ ,  $CE_2 = V_{IH}$ .
18.  $\overline{WE}$  is HIGH for read cycle.
19. Address valid before or similar to  $\overline{CE}_1$  transition LOW and  $CE_2$  transition HIGH.



Switching Waveforms (continued)

Figure 6. Write Cycle No. 1 ( $\overline{WE}$  Controlled) [20, 21, 22]

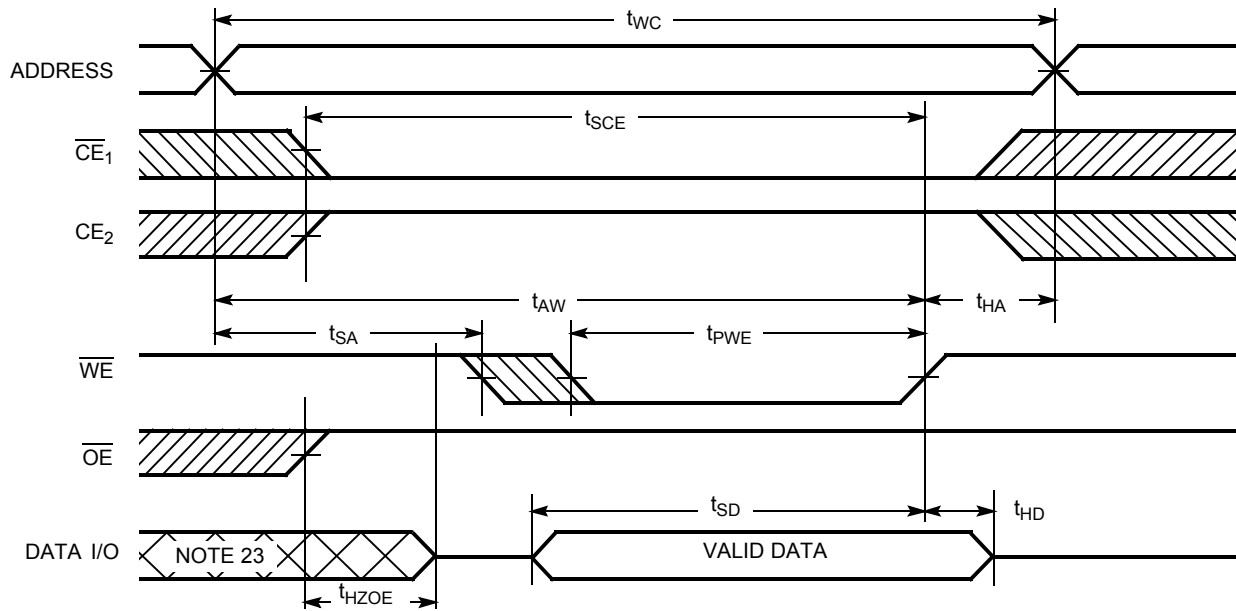
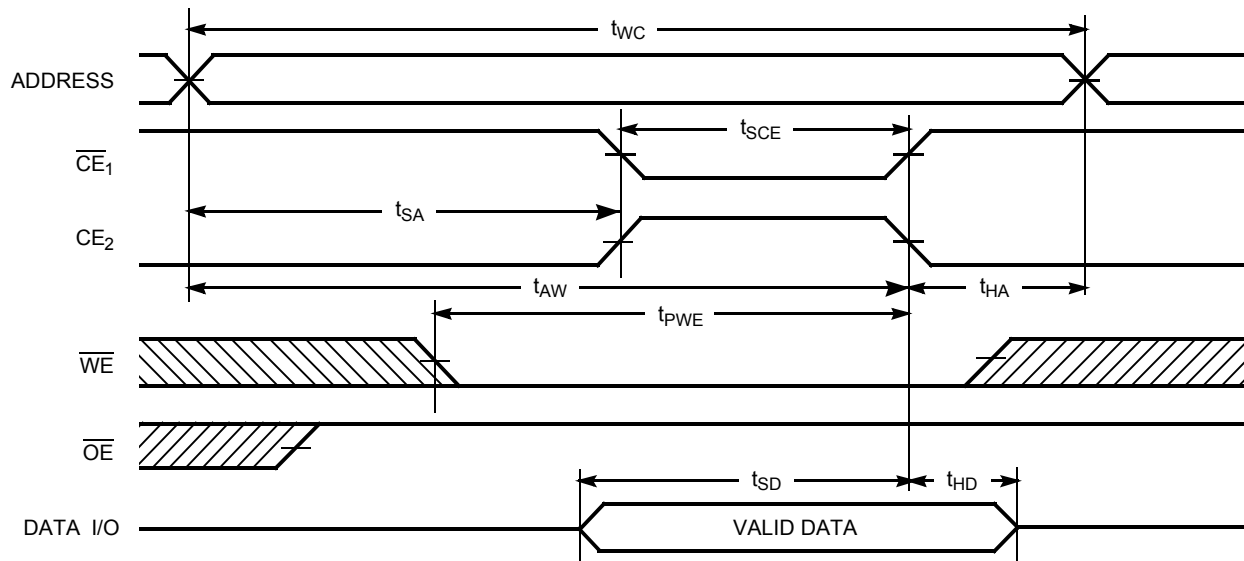

Figure 7. Write Cycle No. 2 ( $\overline{CE}_1$  or  $\overline{CE}_2$  Controlled) [20, 21, 22]



Notes

- 20. The internal write time of the memory is defined by the overlap of  $\overline{WE}$ ,  $\overline{CE}_1 = V_{IL}$ , and  $CE_2 = V_{IH}$ . All signals must be ACTIVE to initiate a write and any of these signals can terminate a write by going INACTIVE. The data input setup and hold timing should be referenced to the edge of the signal that terminates the write.
- 21. Data I/O is high impedance if  $OE = V_{IH}$ .
- 22. If  $\overline{CE}_1$  goes HIGH or  $CE_2$  goes LOW simultaneously with  $\overline{WE}$  HIGH, the output remains in high impedance state.
- 23. During this period, the I/Os are in output state. Do not apply input signals.

Switching Waveforms (continued)

Figure 8. Write Cycle No. 3 ( $\overline{WE}$  Controlled,  $\overline{OE}$  LOW) [24]

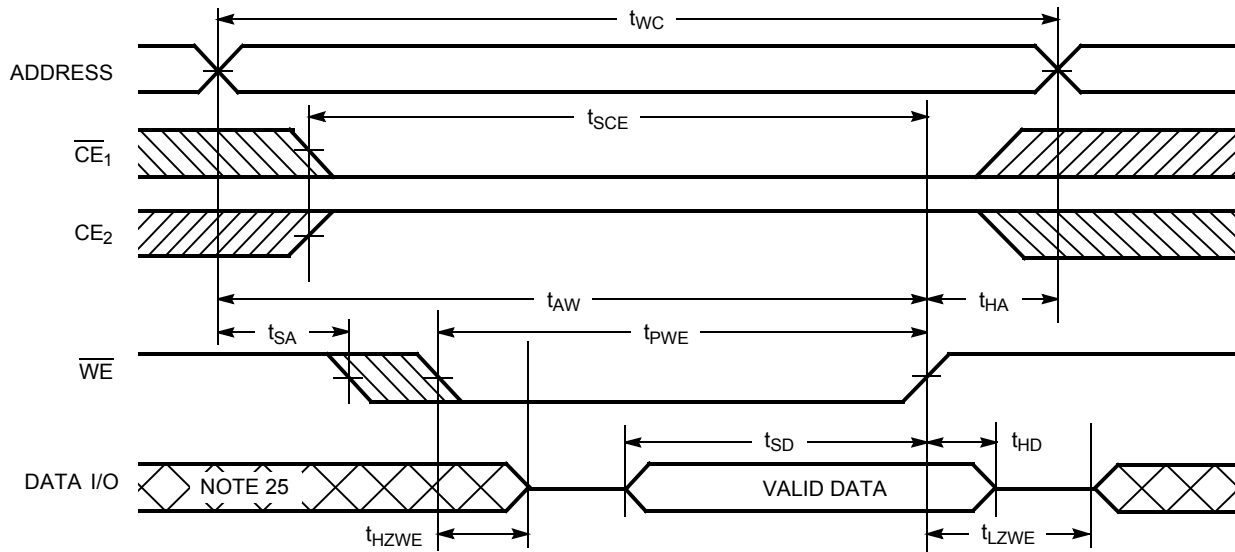

Notes

- 24. If  $\overline{CE}_1$  goes HIGH or  $\overline{CE}_2$  goes LOW simultaneously with  $\overline{WE}$  HIGH, the output remains in high impedance state.
- 25. During this period, the I/Os are in output state. Do not apply input signals.

**Truth Table**

$\overline{CE}_1$	$CE_2$	$\overline{WE}$	$\overline{OE}$	Inputs/Outputs	Mode	Power
H	X <sup>[26]</sup>	X	X	High Z	Deselect/Power Down	Standby ( $I_{SB}$ )
X <sup>[26]</sup>	L	X	X	High Z	Deselect/Power Down	Standby ( $I_{SB}$ )
L	H	H	L	Data Out	Read	Active ( $I_{CC}$ )
L	H	H	H	High Z	Output Disabled	Active ( $I_{CC}$ )
L	H	L	X	Data in	Write	Active ( $I_{CC}$ )

**Note**

26. The 'X' (Don't care) state for the Chip enables in the truth table refer to the logic state (either HIGH or LOW). Intermediate voltage levels on these pins is not permitted.

**Ordering Information**

Speed (ns)	Ordering Code	Package Diagram	Package Type	Operating Range
45	CY62158ELL-45ZSXI	51-85087	44-pin TSOP II (Pb-free)	Industrial

Contact your local Cypress sales representative for availability of this part.

**Ordering Code Definitions**

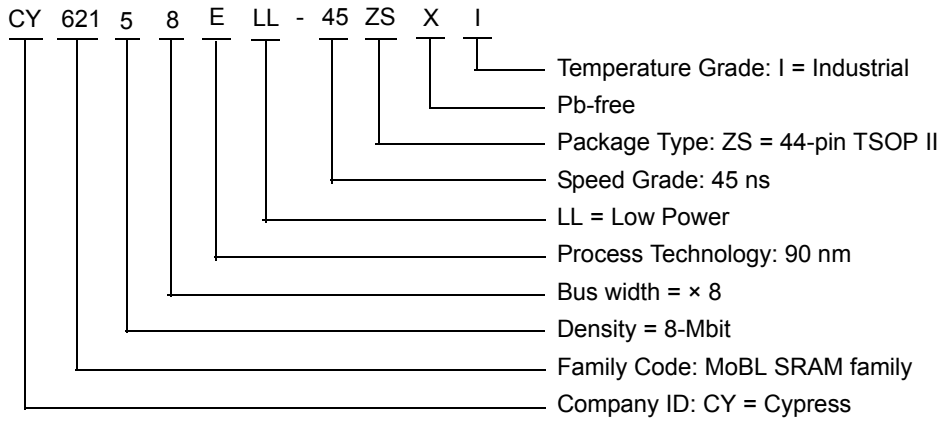

Package Diagrams

Figure 9. 44-pin TSOP Z44-II, 51-85087

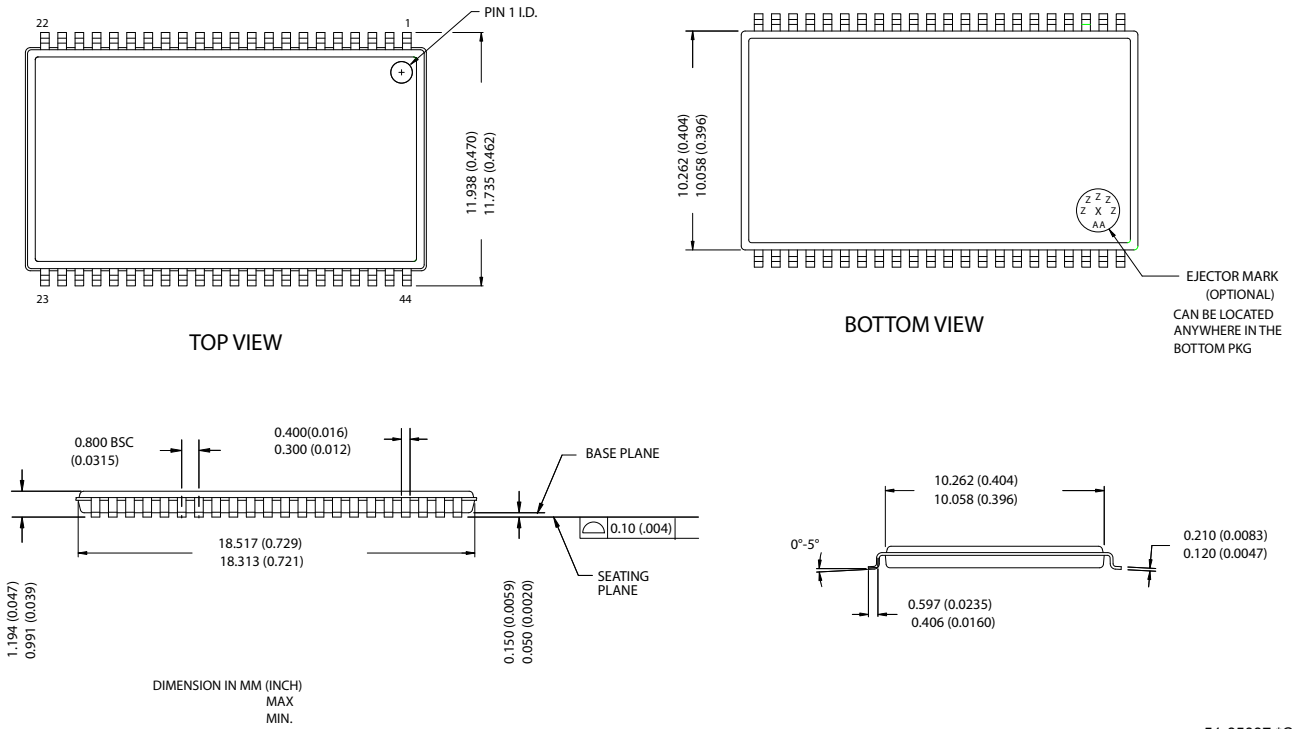

## Acronyms

Acronym	Description
CE	chip enable
CMOS	complementary metal oxide semiconductor
I/O	input/output
OE	output enable
SRAM	static random access memory
TSOP	thin small outline package
WE	write enable

## Document Conventions

### Units of Measure

Symbol	Unit of Measure
°C	degree Celsius
MHz	Mega Hertz
μA	micro Amperes
μs	micro seconds
mA	milli Amperes
ns	nano seconds
Ω	ohms
%	percent
pF	pico Farad
V	Volts
W	Watts

**Document History Page**

Document Title: CY62158E MoBL <sup>®</sup> , 8-Mbit (1 M × 8) Static RAM				
Document Number: 38-05684				
REV.	ECN NO.	Issue Date	Orig. of Change	Description of Change
**	270350	See ECN	PCI	New Data Sheet
*A	291271	See ECN	SYT	Converted from Advance Information to Preliminary Changed input pulse level from $V_{CC}$ to 3V in the AC Test Loads and Waveforms Modified footnote #9 to include timing reference level of 1.5V and input pulse level of 3V
*B	1462592	See ECN	VKN/AESA	Converted from preliminary to final Removed 35 ns speed bin Removed "L" parts Removed 48-Ball VFPGA package Changed $I_{CC(max)}$ spec from 2.3 mA to 3 mA at $f=1$ MHz Changed $I_{CC(typ)}$ spec from 16 mA to 18 mA at $f=f_{MAX}$ Changed $I_{CC(max)}$ spec from 28 mA to 25 mA at $f=f_{MAX}$ Changed $I_{SB1(typ)}$ and $I_{SB2(typ)}$ spec from 0.9 $\mu$ A to 2 $\mu$ A Changed $I_{SB1(max)}$ and $I_{SB2(max)}$ spec from 4.5 $\mu$ A to 8 $\mu$ A Changed $I_{CCDR(max)}$ spec from 4.5 $\mu$ A to 8 $\mu$ A Changed $t_{LZOE}$ spec from 3 ns to 5 ns Changed $t_{LZCE}$ spec from 6 ns to 10 ns Changed $t_{HZCE}$ spec from 22 ns to 18 ns Changed $t_{PWE}$ spec from 30 ns to 35 ns Changed $t_{SD}$ spec from 22 ns to 25 ns Changed $t_{LZWE}$ spec from 6 ns to 10 ns Added footnote# 6 related to $I_{SB2}$ and $I_{CCDR}$ Updated Ordering information table
*C	2428708	See ECN	VKN/PYRS	Corrected typo in the Ordering Information table
*D	2516494	See ECN	PYRS	Corrected ECN number
*E	2934396	06/03/10	VKN	Added footnote #19 related to chip enable Updated package diagram Updated template
*F	3110202	12/14/2010	PRAS	Updated Logic Block Diagram. Added Ordering Code Definitions.
*G	3121955	12/28/2010	SRIH	Updated the missing header and footer in Pg 12.
*H	3279426	06/10/2011	RAME	Updated <a href="#">Functional Description</a> (Removed "For best practice recommendations, refer to the Cypress application note AN1064, SRAM System Guidelines"). Updated <a href="#">Data Retention Characteristics</a> . Added <a href="#">Acronyms</a> and <a href="#">Units of Measure</a> . Updated in new template.

## Sales, Solutions, and Legal Information

### Worldwide Sales and Design Support

Cypress maintains a worldwide network of offices, solution centers, manufacturer's representatives, and distributors. To find the office closest to you, visit us at [Cypress Locations](#).

### Products

<a href="#">Automotive</a>	<a href="http://cypress.com/go/automotive">cypress.com/go/automotive</a>
<a href="#">Clocks &amp; Buffers</a>	<a href="http://cypress.com/go/clocks">cypress.com/go/clocks</a>
<a href="#">Interface</a>	<a href="http://cypress.com/go/interface">cypress.com/go/interface</a>
<a href="#">Lighting &amp; Power Control</a>	<a href="http://cypress.com/go/powerpsoc">cypress.com/go/powerpsoc</a> <a href="http://cypress.com/go/plc">cypress.com/go/plc</a>
<a href="#">Memory</a>	<a href="http://cypress.com/go/memory">cypress.com/go/memory</a>
<a href="#">Optical &amp; Image Sensing</a>	<a href="http://cypress.com/go/image">cypress.com/go/image</a>
<a href="#">PSoC</a>	<a href="http://cypress.com/go/psoc">cypress.com/go/psoc</a>
<a href="#">Touch Sensing</a>	<a href="http://cypress.com/go/touch">cypress.com/go/touch</a>
<a href="#">USB Controllers</a>	<a href="http://cypress.com/go/USB">cypress.com/go/USB</a>
<a href="#">Wireless/RF</a>	<a href="http://cypress.com/go/wireless">cypress.com/go/wireless</a>

### PSoC Solutions

[psoc.cypress.com/solutions](http://psoc.cypress.com/solutions)  
PSoC 1 | PSoC 3 | PSoC 5

---

© Cypress Semiconductor Corporation, 2004-2011. The information contained herein is subject to change without notice. Cypress Semiconductor Corporation assumes no responsibility for the use of any circuitry other than circuitry embodied in a Cypress product. Nor does it convey or imply any license under patent or other rights. Cypress products are not warranted nor intended to be used for medical, life support, life saving, critical control or safety applications, unless pursuant to an express written agreement with Cypress. Furthermore, Cypress does not authorize its products for use as critical components in life-support systems where a malfunction or failure may reasonably be expected to result in significant injury to the user. The inclusion of Cypress products in life-support systems application implies that the manufacturer assumes all risk of such use and in doing so indemnifies Cypress against all charges.

Any Source Code (software and/or firmware) is owned by Cypress Semiconductor Corporation (Cypress) and is protected by and subject to worldwide patent protection (United States and foreign), United States copyright laws and international treaty provisions. Cypress hereby grants to licensee a personal, non-exclusive, non-transferable license to copy, use, modify, create derivative works of, and compile the Cypress Source Code and derivative works for the sole purpose of creating custom software and or firmware in support of licensee product to be used only in conjunction with a Cypress integrated circuit as specified in the applicable agreement. Any reproduction, modification, translation, compilation, or representation of this Source Code except as specified above is prohibited without the express written permission of Cypress.

Disclaimer: CYPRESS MAKES NO WARRANTY OF ANY KIND, EXPRESS OR IMPLIED, WITH REGARD TO THIS MATERIAL, INCLUDING, BUT NOT LIMITED TO, THE IMPLIED WARRANTIES OF MERCHANTABILITY AND FITNESS FOR A PARTICULAR PURPOSE. Cypress reserves the right to make changes without further notice to the materials described herein. Cypress does not assume any liability arising out of the application or use of any product or circuit described herein. Cypress does not authorize its products for use as critical components in life-support systems where a malfunction or failure may reasonably be expected to result in significant injury to the user. The inclusion of Cypress' product in a life-support systems application implies that the manufacturer assumes all risk of such use and in doing so indemnifies Cypress against all charges.

Use may be limited by and subject to the applicable Cypress software license agreement.