

13 Output, 3.3 V Clock Buffer

Features

- One input to 13 output buffer/driver
- Supply voltage: 3.3 V
- Supports up to three SDRAM DIMMs
- SMBus serial interface for output control
- Low skew outputs
- Up to 100-MHz operation
- Multiple V_{DD} and V_{SS} pins for noise reduction
- Low EMI outputs
- Package: 28-pin small-outline integrated circuit (SOIC)

Functional Description

The CY2313ANZ is a 3.3 V clock buffer. While originally designed to distribute clocks in desktop PC applications - hence the signal names - it is a general purpose device suitable to a wide variety of clock buffering applications. The part has thirteen outputs. In a PC application, twelve of which can be used to drive up to three SDRAM DIMMs, and the remaining output can be used for external feedback to a PLL. The device operates at 3.3 V and outputs can run up to 100 MHz.

The CY2313ANZ also includes an SMBus serial interface which can enable or disable each output clock. On power-up, all output clocks are enabled.

Logic Block Diagram

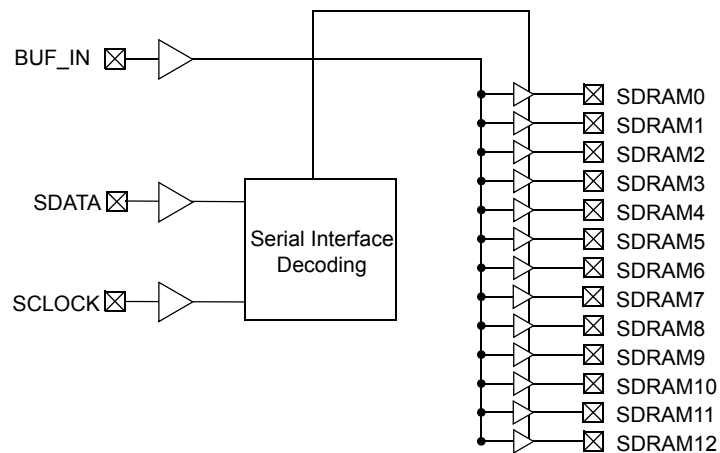

Pin Configuration

Figure 1. 28-pin SOIC (Top View)

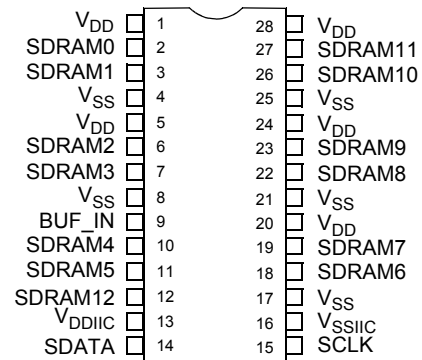

Pin Summary

Name	Pins	Description
V _{DD}	1, 5, 20, 24, 28	3.3 V digital voltage supply
V _{SS}	4, 8, 17, 21, 25	Ground
V _{DDIIC}	13	Serial interface voltage supply
V _{SSIIC}	16	Ground for serial interface
BUF_IN	9	Input clock
SDATA	14	SMBus data input/output, internal pull-up to V _{DD}
SCLK	15	SMBus clock input, internal pull-up to V _{DD}
SDRAM [0-12]	2, 3, 6, 7, 10, 11, 12, 18, 19, 22, 23, 26, 27	Clock outputs

Serial Configuration Map

- The Serial bits will be read by the clock driver in the following order:

Byte 0 - Bits 7, 6, 5, 4, 3, 2, 1, 0

Byte 1 - Bits 7, 6, 5, 4, 3, 2, 1, 0

.

.

.

Byte N - Bits 7, 6, 5, 4, 3, 2, 1, 0

- Reserved and unused bits should be programmed to “0”
- Serial interface address for the CY2313ANZ is:

A6	A5	A4	A3	A2	A1	A0	R/W
1	1	0	1	0	0	1	–

Byte 0:SDRAM Active/Inactive Register (1 = Enable, 0 = Disable), Default = Enabled

Bit	Pin #	Description
Bit 7	11	SDRAM5 (active/inactive)
Bit 6	10	SDRAM4 (active/inactive)
Bit 5	–	Reserved, drive to 0
Bit 4	–	Reserved, drive to 0
Bit 3	7	SDRAM3 (active/inactive)
Bit 2	6	SDRAM2 (active/inactive)
Bit 1	3	SDRAM1 (active/inactive)
Bit 0	2	SDRAM0 (active/inactive)

Byte 1: SDRAM Active/Inactive Register (1 = Active, 0 = Inactive), Default = Active

Bit	Pin #	Description
Bit 7	27	SDRAM11 (active/inactive)
Bit 6	26	SDRAM10 (active/inactive)
Bit 5	23	SDRAM9 (active/inactive)
Bit 4	22	SDRAM8 (active/inactive)
Bit 3	–	Reserved, drive to 0
Bit 2	–	Reserved, drive to 0
Bit 1	19	SDRAM7 (active/inactive)
Bit 0	18	SDRAM6 (active/inactive)

Byte 2: SDRAM Active/Inactive Register (1 = Active, 0 = Inactive), Default = Active

Bit	Pin #	Description
Bit 7	–	Reserved, drive to 0
Bit 6	12	SDRAM12 (active/inactive)
Bit 5	–	Reserved, drive to 0
Bit 4	–	Reserved, drive to 0
Bit 3	–	Reserved, drive to 0
Bit 2	–	Reserved, drive to 0
Bit 1	–	Reserved, drive to 0
Bit 0	–	Reserved, drive to 0

Maximum Ratings

Exceeding maximum ratings may shorten the useful life of the device. User guidelines are not tested.

Supply voltage to ground potential -0.5 V to +7.0 V

DC input voltage (Except BUF_IN) -0.5 V to $V_{DD} + 0.5$ V

DC input voltage (BUF_IN) -0.5 V to +7.0 V

Storage temperature -65 °C to +150 °C

Junction temperature 150 °C

Static discharge voltage
(per MIL-STD-883, method 3015) > 2000 V

Operating Conditions^[1]

Parameter	Description	Min	Max	Unit
V_{DD}	Supply voltage	3.135	3.465	V
T_A	Operating temperature (ambient temperature)	0	70	°C
C_L	Load capacitance	–	30	pF
C_{IN}	Input capacitance	–	7	pF
t_{PU}	Power-up time for all V_{DD} 's to reach minimum specified voltage (power ramps must be monotonic)	0.05	50	ms

Electrical Characteristics

Over the Operating Range

Parameter	Description	Test Conditions	Min	Max	Unit
V_{IL}	Input LOW voltage ^[2]	Except serial interface pins	–	0.8	V
V_{ILiic}	Input LOW voltage	For serial interface pins only	–	0.7	V
V_{IH}	Input HIGH voltage ^[2]		2.0	–	V
I_{IL}	Input LOW current (BUF_IN input)	$V_{IN} = 0$ V	–10	10	μA
I_{IL}	Input LOW current (Except BUF_IN pin)	$V_{IN} = 0$ V	–	100	μA
I_{IH}	Input HIGH current	$V_{IN} = V_{DD}$	–10	10	μA
V_{OL}	Output LOW voltage ^[3]	$I_{OL} = 25$ mA	–	0.4	V
V_{OH}	Output HIGH voltage ^[3]	$I_{OH} = -36$ mA	2.4	–	V
I_{DD}	Supply current ^[3]	Unloaded outputs, 100 MHz	–	200	mA
I_{DD}	Supply current ^[3]	Loaded outputs, 100 MHz	–	290	mA
I_{DD}	Supply current ^[3]	Unloaded outputs, 66.67 MHz	–	150	mA
I_{DD}	Supply current ^[3]	Loaded outputs, 66.67 MHz	–	185	mA
I_{DDs}	Supply current	BUF_IN = V_{DD} or V_{SS} All other inputs at V_{DD}	–	500	μA

Notes

1. Electrical parameters are guaranteed under the operating conditions specified.
2. BUF_IN input has a threshold voltage of $V_{DD}/2$.
3. Parameter is guaranteed by design and characterization. Not 100% tested in production.

Switching Characteristics^[4]

Over the Operating Range

Parameter	Name	Test Conditions	Min	Typ	Max	Unit
	Maximum operating frequency		–	–	100	MHz
	Duty cycle ^[5, 6] = $t_2 \div t_1$	Measured at 1.5 V	45	50	55	%
t_3	Rising edge rate ^[5]	Measured between 0.4 V and 2.4 V	0.9	1.5	4.0	V/ns
t_4	Falling edge rate ^[5]	Measured between 2.4 V and 0.4 V	0.9	1.5	4.0	V/ns
t_5	Output to output skew ^[5]	All outputs equally loaded	–250	–	250	ps
t_6	SDRAM buffer LH propagation delay ^[5]	Input edge greater than 1 V/ns	1.0	3.5	5.0	ns
t_7	SDRAM buffer HL propagation delay ^[5]	Input edge greater than 1 V/ns	1.0	3.5	5.0	ns

Switching Waveforms

Figure 2. Duty Cycle Timing

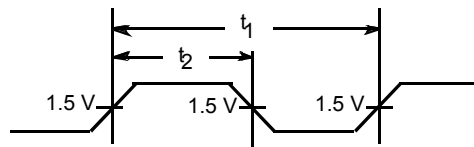

Figure 3. All Outputs Rise/Fall Time

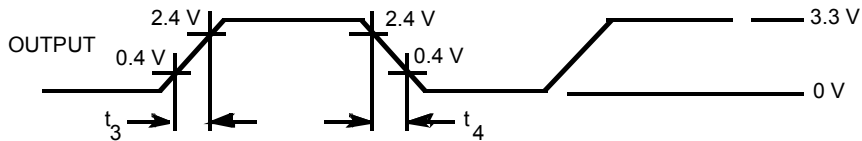
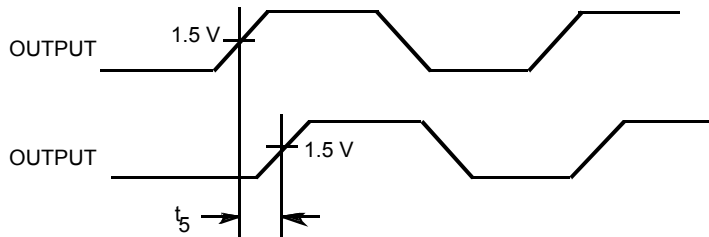

Figure 4. Output-Output Skew



Notes

- 4. All parameters specified with loaded outputs.
- 5. Parameter is guaranteed by design and characterization. Not 100 percent tested in production.
- 6. Duty cycle of input clock is 50 percent. Rising and falling edge rate of the input clock is greater than 1 V/ns.

Switching Waveforms (continued)

Figure 5. SDRAM Buffer LH and HL Propagation Delay

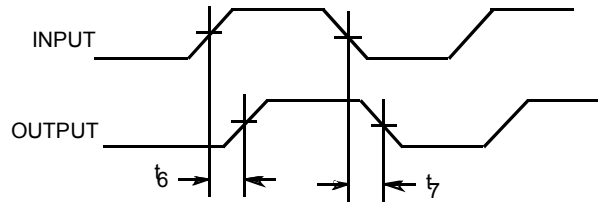

Test Circuit

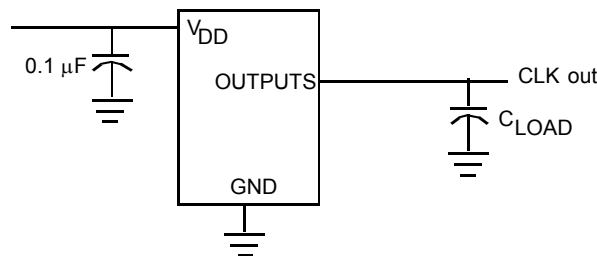

Application Information

- Clock traces may require either series or parallel termination. An IBIS model is available for simulation.
- Surface mount, low-ESR, ceramic capacitors should be used for filtering. Typically, these capacitors have a value of $0.1 \mu F$. In some cases, smaller value capacitors may be required.
- The value of the series terminating resistor satisfies the following equation, where R_{trace} is the loaded characteristic impedance of the trace, R_{out} is the output impedance of the buffer (typically 25Ω), and R_{series} is the series terminating resistor.

$$R_{series} > R_{trace} - R_{out}$$
- Footprints must be laid out for optional EMI-reducing capacitors, which should be placed as close to the terminating resistor as is physically possible. Typical values of these capacitors range from 4.7 pF to 22 pF .
- A ferrite bead may be used to isolate the board V_{DD} from the clock generator V_{DD} island. Ensure that the Ferrite Bead offers greater than 50Ω impedance at the clock frequency, under loaded DC conditions. Refer to the application note [Layout and Termination Techniques for Cypress Clock Generators](#) for more details.
- If a Ferrite Bead is used, a $10 \mu F$ to $22 \mu F$ tantalum bypass capacitor should be placed close to the Ferrite Bead. This capacitor prevents power supply droop during current surges.

Ordering Information

Ordering Code	Package Type	Operating Range
CY2313ANZSC-1	28-pin SOIC	Commercial, 0 °C to 70 °C
Pb-free		
CY2313ANZSXC-1	28-pin SOIC	Commercial, 0 °C to 70 °C
CY2313ANZSXC-1T	28-pin SOIC Tape and Reel	Commercial, 0 °C to 70 °C

Ordering Code Definitions

CY 2313ANZ xx C - 1 (T)

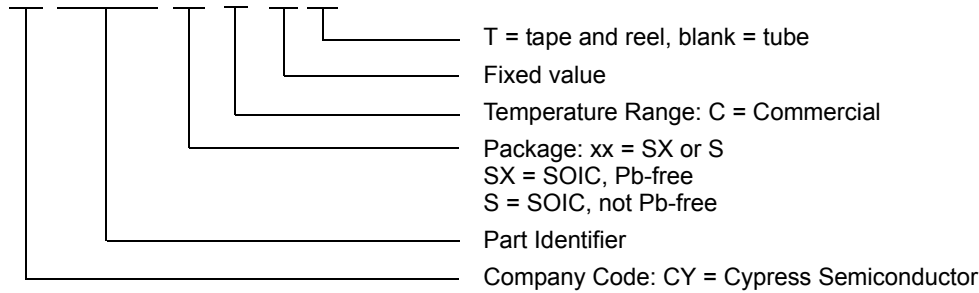

Package Diagram

Figure 6. 28-pin (300-Mil) Molded SOIC

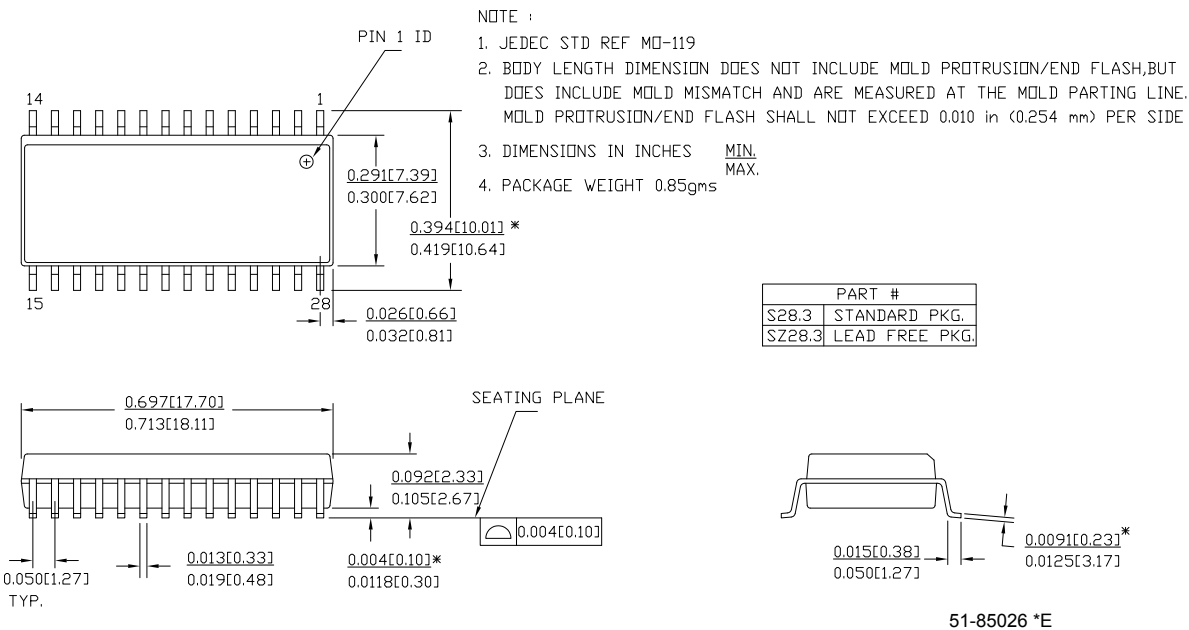

Acronyms

Acronym	Description
DIMM	dual in-line memory module
PC	personal computer
PLL	phase-locked loop
SDRAM	synchronous dynamic random access memory
SOIC	small-outline integrated circuit

Document Conventions

Units of Measure

Symbol	Unit of Measure
°C	degree Celcius
μA	micro Amperes
mA	milli Amperes
ms	milli seconds
MHz	Mega Hertz
ns	nano seconds
Ω	ohms
pF	pico Farad
V	Volts

Document History Page

Document Title: CY2313ANZ 13 Output, 3.3 V Clock Buffer Document Number: 38-07144				
REV.	ECN NO.	Issue Date	Orig. of Change	Description of Change
**	110253	11/18/01	DSG	Change from Spec number: 38-00692 to 38-07144
*A	121831	12/14/02	RBI	Power up requirements added to Operating Conditions Information
*B	1244583	See ECN	DPF	Added Pb-free part numbers in the Ordering Information
*C	3022355	09/14/2010	KVM	Changed title from "13 Output, 3.3 V SDRAM Buffer for Desktop PCs with Three DIMMs" to "13 Output, 3.3 V Clock Buffer" Clarified that the serial interface is SMBus Removed timing parameters and waveforms that were not applicable Added Ordering Code Definitions Updated Package Diagram Added Acronyms and Document Conventions Minor edits and updated in new template

Sales, Solutions, and Legal Information

Worldwide Sales and Design Support

Cypress maintains a worldwide network of offices, solution centers, manufacturer’s representatives, and distributors. To find the office closest to you, visit us at [Cypress Locations](#).

Products

Automotive	cypress.com/go/automotive
Clocks & Buffers	cypress.com/go/clocks
Interface	cypress.com/go/interface
Lighting & Power Control	cypress.com/go/powerpsoc cypress.com/go/plc
Memory	cypress.com/go/memory
Optical & Image Sensing	cypress.com/go/image
PSoC	cypress.com/go/psoc
Touch Sensing	cypress.com/go/touch
USB Controllers	cypress.com/go/USB
Wireless/RF	cypress.com/go/wireless

PSoC Solutions

psoc.cypress.com/solutions
PSoC 1 | PSoC 3 | PSoC 5

© Cypress Semiconductor Corporation, 2001-2010. The information contained herein is subject to change without notice. Cypress Semiconductor Corporation assumes no responsibility for the use of any circuitry other than circuitry embodied in a Cypress product. Nor does it convey or imply any license under patent or other rights. Cypress products are not warranted nor intended to be used for medical, life support, life saving, critical control or safety applications, unless pursuant to an express written agreement with Cypress. Furthermore, Cypress does not authorize its products for use as critical components in life-support systems where a malfunction or failure may reasonably be expected to result in significant injury to the user. The inclusion of Cypress products in life-support systems application implies that the manufacturer assumes all risk of such use and in doing so indemnifies Cypress against all charges.

Any Source Code (software and/or firmware) is owned by Cypress Semiconductor Corporation (Cypress) and is protected by and subject to worldwide patent protection (United States and foreign), United States copyright laws and international treaty provisions. Cypress hereby grants to licensee a personal, non-exclusive, non-transferable license to copy, use, modify, create derivative works of, and compile the Cypress Source Code and derivative works for the sole purpose of creating custom software and or firmware in support of licensee product to be used only in conjunction with a Cypress integrated circuit as specified in the applicable agreement. Any reproduction, modification, translation, compilation, or representation of this Source Code except as specified above is prohibited without the express written permission of Cypress.

Disclaimer: CYPRESS MAKES NO WARRANTY OF ANY KIND, EXPRESS OR IMPLIED, WITH REGARD TO THIS MATERIAL, INCLUDING, BUT NOT LIMITED TO, THE IMPLIED WARRANTIES OF MERCHANTABILITY AND FITNESS FOR A PARTICULAR PURPOSE. Cypress reserves the right to make changes without further notice to the materials described herein. Cypress does not assume any liability arising out of the application or use of any product or circuit described herein. Cypress does not authorize its products for use as critical components in life-support systems where a malfunction or failure may reasonably be expected to result in significant injury to the user. The inclusion of Cypress’ product in a life-support systems application implies that the manufacturer assumes all risk of such use and in doing so indemnifies Cypress against all charges.

Use may be limited by and subject to the applicable Cypress software license agreement.