

High Power SPDT Switch with Logic Control

Description

The CXG1104TN is a high power antenna switch MMIC for use in cellular handsets, for example, CDMA.

The CXG1104TN has on-chip logic, which enables the switch circuit to operate by 1 CMOS control line.

The Sony JFET process is used for low insertion loss and on-chip logic circuit.

Features

- Low insertion loss: 0.3dB @900MHz, 0.4dB @1.9GHz
- High linearity: IIP3 (Typ.) = 64dBm
- 1 CMOS compatible control line
- Small package size: 10-pin TSSOP

Applications

Cellular handsets, for example, narrow band CDMA and wide band CDMA

Structure

GaAs J-FET MMIC

Absolute Maximum Ratings (Ta = 25°C)

• Bias voltage	V _{DD}	7	V
• Control voltage	V _{ctl}	5	V
• Operating temperature	T _{opr}	-35 to +85	°C
• Storage temperature	T _{stg}	-65 to +150	°C

10 pin TSSOP (Plastic)

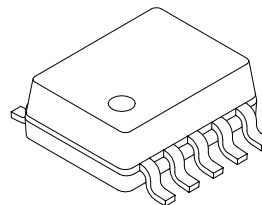

GaAs MMICs are ESD sensitive devices. Special handling precautions are required. The actual ESD test data will be available later.

Sony reserves the right to change products and specifications without prior notice. This information does not convey any license by any implication or otherwise under any patents or other right. Application circuits shown, if any, are typical examples illustrating the operation of the devices. Sony cannot assume responsibility for any problems arising out of the use of these circuits.

Block Diagram and Recommended Circuit

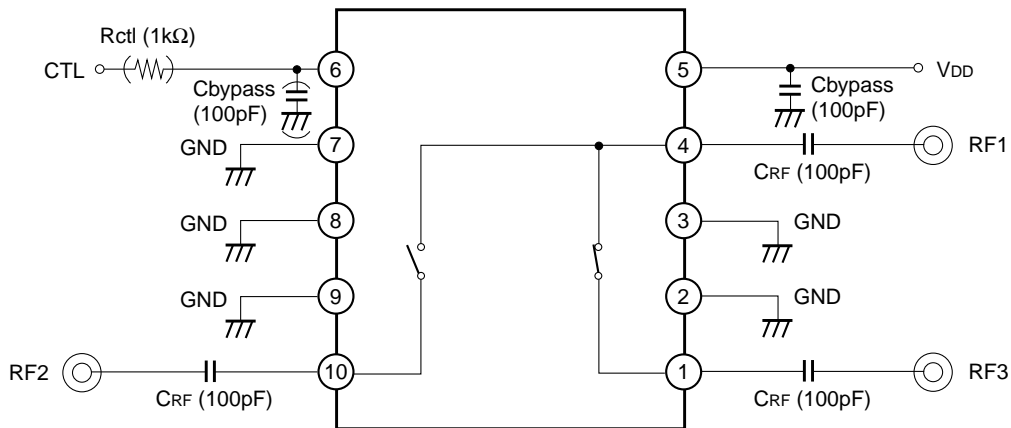

When using this IC, the following external components should be used:

- Rctl: This resistor is used to improve ESD performance. 1kΩ is recommended.
- CRF: This capacitor is used for RF decoupling and must be used for all applications. 100pF is recommended.
- Cbypass: This capacitor is used for DC line filtering. 100pF is recommended.

Truth Table

On Pass	CTL
RF1 – RF2	L
RF1 – RF3	H

DC Bias Condition

(Ta = 25°C)

Item	Min.	Typ.	Max.	Unit
Vctl (H)	2.0	3.0	3.6	V
Vctl (L)	0	—	0.8	V
VDD	2.6	3.0	4.5	V

Electrical Characteristics

(Ta = 25°C)

Item	Symbol	Condition	Min.	Typ.	Max.	Unit
Insertion loss	IL	900MHz		0.30	0.55	dB
		1.9GHz		0.40	0.65	dB
Isolation	ISO.	900MHz	20	23		dB
		1.9GHz	14	16.5		dB
VSWR	VSWR	900MHz, 1.9GHz		1.2	1.4	—
Harmonics	2fo	*1	-60	-75		dBc
	3fo	*1	-60	-75		dBc
1dB compression input power	P1dB	V _{DD} = 3.0V, 0/3V control	32	35		dBm
Input IP3	IIP3	*2	55	64		dBm
Switching speed	TSW			2	5	μs
Control current	I _{ctl}	V _{ctl} (High) = 3V		40	80	μA
Bias current	I _{DD}	V _{DD} = 3V		100	200	μA

*1 Pin = 29dBm, 900MHz, V_{DD} = 3.0V, 0/3V control

*2 Pin = 24dBm (900MHz) + 24dBm (901MHz), V_{DD} = 3.0V, 0/3V control

Package Outline Unit: mm

10PIN TSSOP (PLASTIC)

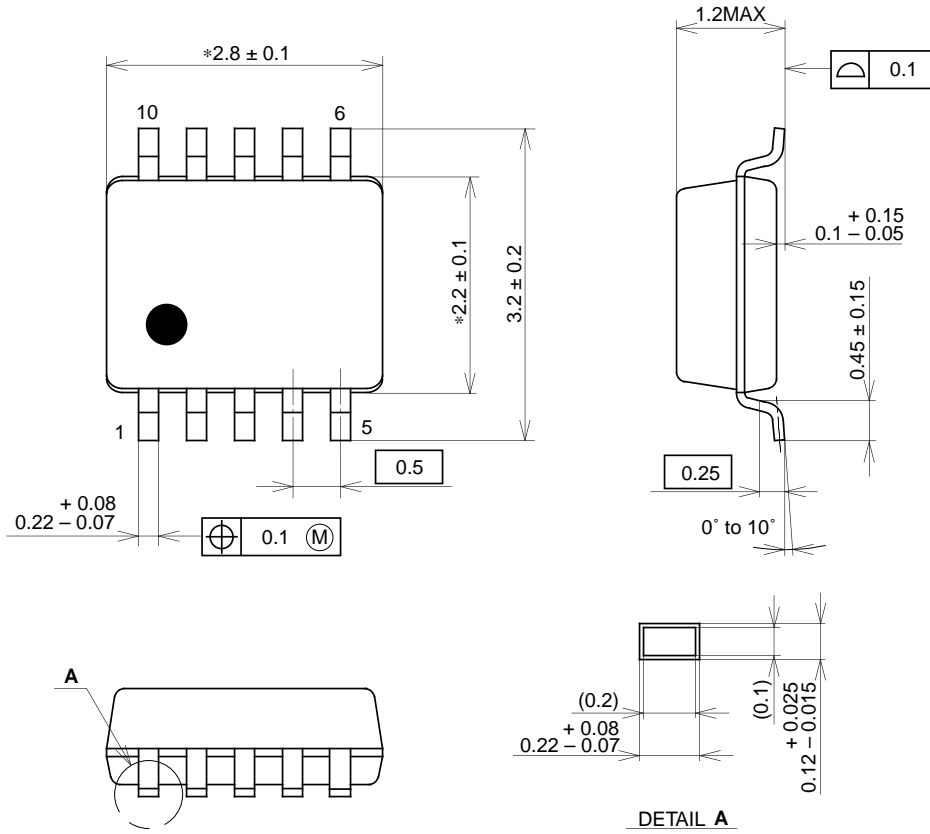

NOTE: Dimension "*" does not include mold protrusion.

PACKAGE STRUCTURE

SONY CODE	TSSOP-10P-L01
EIAJ CODE	_____
JEDEC CODE	_____

PACKAGE MATERIAL	EPOXY RESIN
LEAD TREATMENT	SOLDER PLATING
LEAD MATERIAL	COPPER ALLOY
PACKAGE MASS	0.02g