

IF Amplifier for Digital Cordless Telephone

Description

The CXA1744AR is an IF amplifier IC designed for digital cordless telephone of Europe, CT-2.

Features

- Mixer, RSSI, detector, and various other functions required of a digital cordless phone IF amplifier.
- Local oscillator and multiplier for the mixer.
- Low power consumption (8.4mA at 3.0V)
- Small package (48-pin LQFP).

Absolute Maximum Ratings (Ta=25°C)

- | | | | |
|-------------------------------|------------------|-------------|----|
| • Supply voltage | V _{CC} | 14 | V |
| • Operating temperature | T _{opr} | -20 to +75 | °C |
| • Storage temperature | T _{stg} | -65 to +150 | °C |
| • Allowable power dissipation | P _D | 500 | mW |

Recommended Operating Condition

- | | | | |
|------------------|-----------------|------------|---|
| • Supply voltage | V _{CC} | 2.7 to 5.5 | V |
|------------------|-----------------|------------|---|

48 pin LQFP (Plastic)

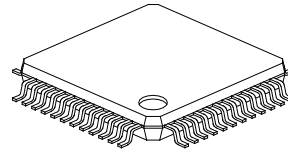

Structure

Bipolar silicon monolithic IC

Applications

Digital cordless telephone of Europe (CT-2)

Block Diagram and Pin Configuration

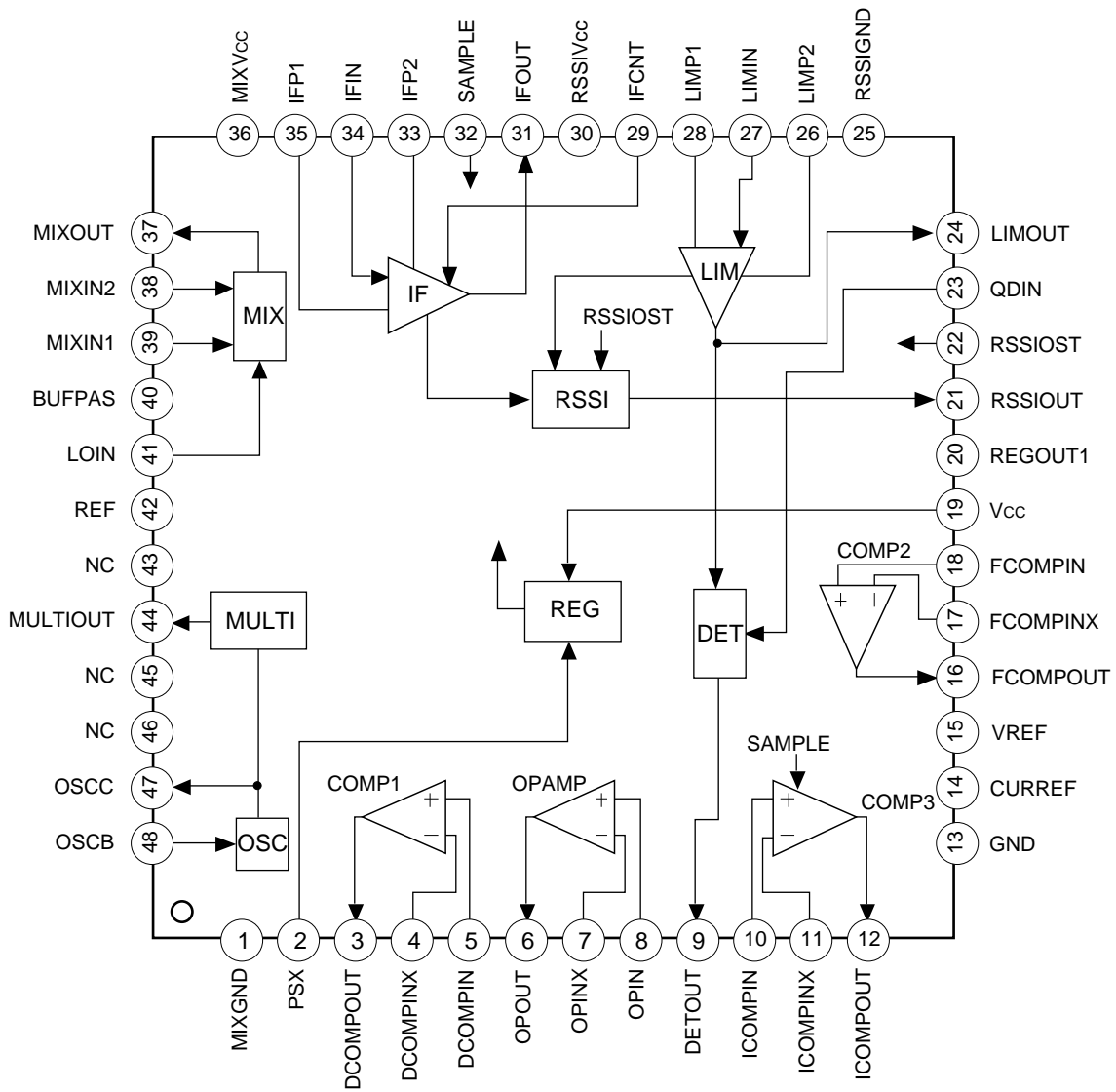

Pin Description

Pin No.	Symbol	Typical pin voltage	Equivalent circuit	Description
1	MIXGND	0V		GND for the MIX, OSC, and MULTI circuits.
2	PSX	0V		Power save control. Power save mode for Low; power save function executes on all circuits except the OSC circuit and a part of the REG circuit.
3	DCOMPOUT	—		Data slicer comparator output.
4	DCOMPINX	—		Data slicer comparator input. DCOMPINX is for out-of-phase input.
5	DCOMPIN	—		DCOMPIN is for in-phase input.
6	OPOUT	—		Operational amplifier output.
7	OPINX	—		Operational amplifier input. OPINX is for out-of-phase input.
8	OPIN	—		OPIN is for in-phase input.
9	DETOUT	1.25V		Detector output.

Pin No.	Symbol	Typical pin voltage	Equivalent circuit	Description
10	ICOMPIN	—		Sample-and-hold circuit input. ICOMPIN is for in-phase input. ICOMPINX is for out-of-phase input.
11	ICOMPINX			
12	ICOMPOUT	—		Sample-and-hold circuit output.
13	GND	0V		GND for circuits other than the MIX, OSC, MULTI, and RSSI circuits.
14	CURREF	1.25V		Adjustment for RSSI output current. Connects a resistor between this pin and GND.
15	VREF	1.9V		Reference voltage. Leave this pin open normally.
16	FCOMPOUT	—		Comparator output for free-channel detection.
17	FCOMPINX	—		Comparator input for free-channel detection. FCOMPINX is for out-of-phase input. FCOMPIN is for in-phase input.
18	FCOMPIN			

Pin No.	Symbol	Typical pin voltage	Equivalent circuit	Description
19	Vcc	3.0V		Power supply for circuits other than the MIX, OSC, MULTI, and RSSI circuits.
20	REGOUT1	1.25V		Internal bias regulator output. A stabilized bias voltage can be obtained.
21	RSSIOUT	—		RSSI current output. A voltage output is obtained when a resistor is connected between this pin and GND.
22	RSSIOST	1.25V		RSSI offset adjustment. The offset amount of RSSI output current can be adjusted by connecting a resistor between this pin and GND.
23	QDIN	2.45V		Detector input. Connect a detection discriminator.
24	LIMOUT	1.55V		Limiter output.
25	RSSIGND	0V		GND for the IF amplifier, limiter and RSSI circuits.

Pin No.	Symbol	Typical pin voltage	Equivalent circuit	Description
26	LIMP2	1.5V		Limiter input. Input the signal from IF amplifier to LIMIN. Connect a decoupling capacitor to LIMP1 and LIMP2.
27	LIMIN			
28	LIMP1			
29	IFCNT	0.6V		IF amplifier gain adjustment. Connect a resistor between this pin and GND to compensate for the interstage filter insertion loss between the IF amplifier and limiter.
30	RSSIvcc	2.45V		Power supply for the IF amplifier, limiter and RSSI circuits. Connected to the regulator output internally. Connect a decoupling capacitor.
31	IFOUT	1.55V		IF amplifier output.
32	SAMPLE	3.0V		Sample-and-hold circuit control input. Sample mode for open or High; hold mode for Low.
33	IFP2	1.55V		IF amplifier input. Input the signal from MIX to IFIN. Connect a decoupling capacitor to IFP1 and IFP2.
34	IFIN			
35	IFP1			
36	MIXVcc	3.0V		Power supply for the MIX, OSC, and MULTI circuits.

Pin No.	Symbol	Typical pin voltage	Equivalent circuit	Description
37	MIXOUT	1.4V		Mixer output.
38	MIXIN2	1.2V		Mixer RF signal differential input and bias. Connect a decoupling capacitor to REF.
39	MIXIN1			
42	REF			
40	BUFPAS	1.75V		Mixer local signal input. Connect a decoupling capacitor to BUFPAS. Input the local signal to LOIN.
41	LOIN			
44	MULTIOUT	—		Multiplier current output. Connect a tank circuit between this pin and power supply.
47	OSCC	—		The Colpitts-type oscillation circuit is composed by connecting a crystal oscillator. Input to the OSCC pin when using an external oscillator.
48	OSCB	2.75V		

Electrical Characteristics (VCC=3.0V, Ta=25°C, refer to the Electrical Characteristics Measurement Circuit)

Item	Symbol	SW set to ON	Measurement conditions		Min.	Typ.	Max.	Unit
Current consumption 1	Icc		For operating VIN7=10MHz, 0dBm	I7	6.4	8.4	11.2	mA
Current consumption 2	Icc	S1	For power saving VIN7=10MHz, 0dBm	I7	—	0.2	0.5	mA
Mixer conversion gain	GVMIX		VIN5=150.05MHz, -40dBm VIN6=139.35MHz, -10dBm RL=330Ω	V3	15.5	18	20.5	dB
Mixer output resistance	ROMIX				240	330	420	Ω
IF AMP voltage gain	GIF	S10	VIN4=10.7MHz, -60dBm RL=470Ω	V2	31	33.5	36	dB
IF AMP input resistance	RIIF				240	330	420	Ω
IF AMP output resistance	ROIF				320	440	560	Ω
Limiter voltage gain	GLIM		VIN3=10.7MHz, -80dBm	24pin	64	66.5	69	dB
Limiter input resistance	RILIM				340	460	580	Ω
Limiter output voltage amplitude	VLIM		VIN3=10.7MHz, -20dBm	24pin	320	400	480	mVp-p
RSSI output current inclination (IF)			VIN4=10.7MHz, -30~0dBm	I8	0.32	0.4	0.54	μA/dB
RSSI output current inclination (LIM)			VIN3=10.7MHz, -45~-15dBm	I8	0.32	0.4	0.54	μA/dB
RSSI dynamic range	DRSSI		For MIXIN input		75	80	—	dB
RSSI relative precision					—	—	±3	dB
RSSI output voltage range					0.2	—	1.3	V
Detector output voltage	VDET		VIN3=10.7MHz, -20dBm	V1	160	200	240	mVrms
Detector total harmonic distortion	THD		FMOD=36kHz, fDEV=±25kHz	V1	—	—	3.0	%
Detector maximum output voltage					1.2	—	—	Vp-p
Detector output voltage High level					Vcc	—	—	V
Detector output voltage Low level					-1.1	—	—	V
REG1 output voltage	VREG1	S9	IL=300μA	20pin	1.07	1.17	1.27	V
COMP1 output saturation voltage	ISAT1	S2	VIN1=1.1V, Isink=5mA	3pin	—	0.35	0.5	V
COMP1 output leak current	ILEAK1			I1	—	—	1.0	μA
COMP1 input bias current	IB1	S3 S4	Measured value/2	I2	-200	-70	—	nA
COMP1 rise time	tr1		VIN1=DC level 1.3V	3pin	—	70	200	nsec
COMP1 fall time	tf1		Rectangular wave of 100kHz, 0.5Vp-p		—	40	200	nsec
COMP1 rise propagation delay time	tpdr1		RL=1KΩ, CL=20PF		—	130	500	nsec
COMP1 fall propagation delay time	tpdf1				—	160	500	nsec
COMP1 input dynamic range			For Vref=1.3V		0.3	—	Vcc	V

Item	Symbol	SW set to ON	Measurement conditions		Min.	Typ.	Max.	Unit
COMP2 output saturation voltage	ISAT2	S6	V _{IN2} =1.1V, I _{sink} =1mA	16pin	—	0.2	0.4	V
COMP2 output leak current	I _{LEAK2}			I5	—	—	1.0	μA
COMP2 input bias current	IB2	S7 S8	Measured value/2	I6	-200	-70	—	nA
COMP2 rise time	tr2		V _{IN2} =DC level 1.3V	16pin	—	300	500	nsec
COMP2 fall time	tf2		Rectangular wave of 100kHz, 0.5V _{P-P}		—	30	500	nsec
COMP2 rise propagation delay time	tpdr2		RL=4.7kΩ, CL=20pF		—	200	500	nsec
COMP2 fall propagation delay time	tpdf2				—	170	500	nsec
COMP2 input dynamic range			For V _{ref} =1.3V		0	—	V _{CC}	V
OPAMP input bias range	IB		Measured value/2	I3	-200	-70	—	nA
OPAMP in-phase input voltage range	V _{ICM}				0.4	—	V _{CC} -1.1	V
OPAMP output voltage range					0.4	—	V _{CC} -1.1	V
Sample-and-hold circuit High leak current	I _{LEAKH}	S5 S11	For hold	I4	—	—	100	nA
Sample-and-hold circuit Low leak current	I _{LEAKL}	S11			-100	—	—	nA
Sample-and-hold circuit control voltage High					0.8 X V _{CC}	—	—	V
Sample-and-hold circuit control voltage Low					—	—	0.13 X V _{CC}	V
Sample-and-hold circuit OFF current time for High output			Sample→Hold (For S11 OFF→ON)	12pin	—	1.2	3.0	μsec
Sample-and-hold circuit OFF current time for Low output		S5	Sample→Hold (For S11 OFF→ON), V _S =1.1V	12pin	—	1.2	3.0	μsec

Design Reference Values

(V_{CC}=3.0V, T_a=25°C)

Item	Symbol	Conditions	Min.	Typ.	Max.	Unit
Multiplier output amplitude	V _{MLT}	f _{in} =27.87MHz, -10dBm	—	200	—	mV _{P-P}
3rd order intercepting point	IP3		—	-8	—	dBm
RF input impedance S11 real component		f _{in} =150.05MHz	—	145	—	Ω
RF input impedance S11 imaginary component		f _{in} =150.05MHz	—	-380	—	Ω
Mixer noise figure		SBB conversion	—	11	—	dB
IF amplifier voltage gain difference (for adjustment)		R _L =470Ω, difference to Pin 29 open	—	3	—	dB
RSSI rise time		For input signal OFF/ON	—	30	—	μsec
RSSI fall time		For input signal ON/OFF	—	50	—	μsec
RSSI rise time		For burst operation	—	40	—	μsec
RSSI fall time		For burst operation	—	40	—	μsec
Input sensitivity (12 dB SINAD value)		For MIXIN input (50Ω LC matching) (50Ω LC matching)	—	4.5	—	μV

Electrical Characteristics Measurement Circuit

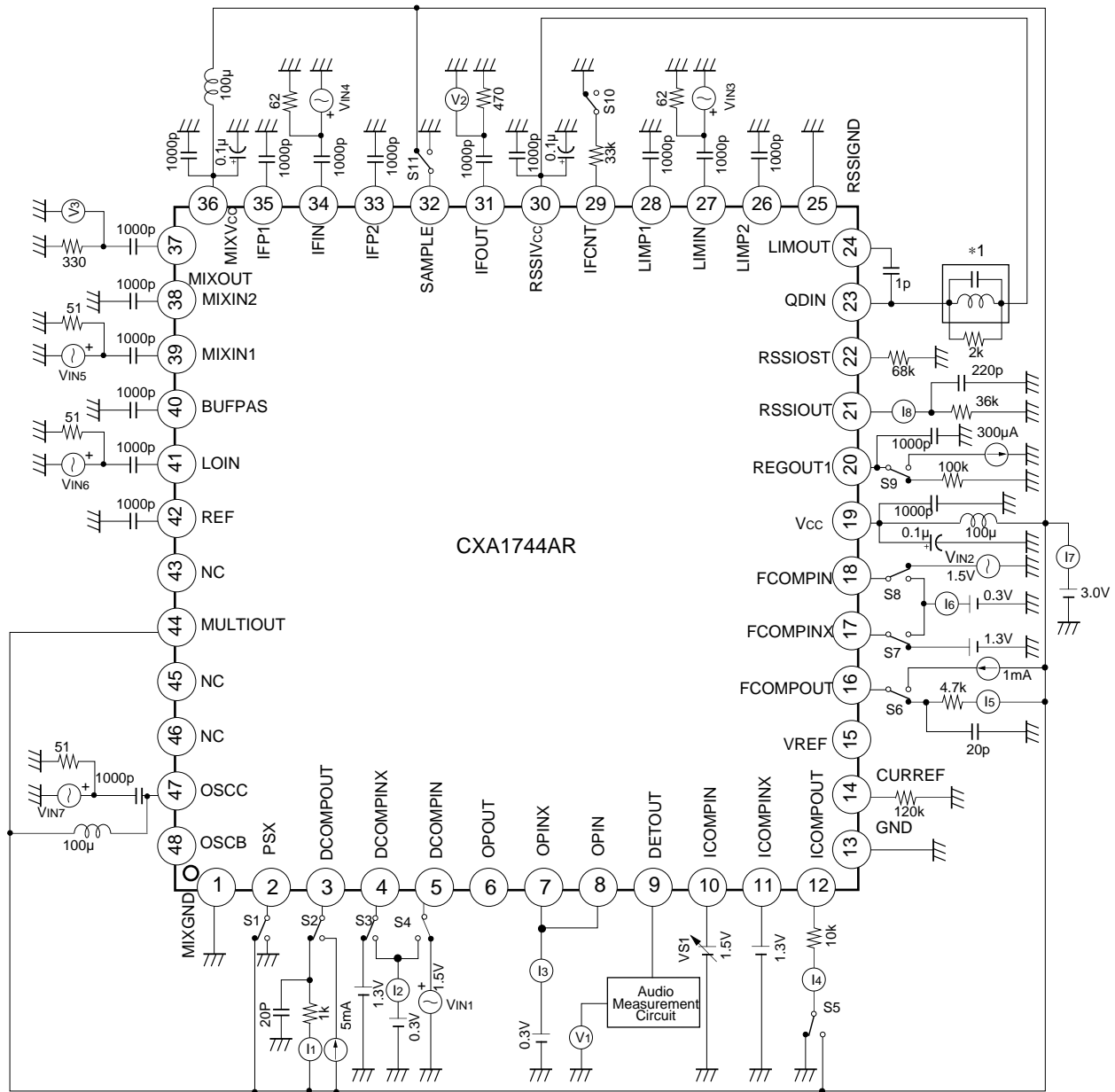

*1 303AC-1941NK (Toko)

Application Circuit

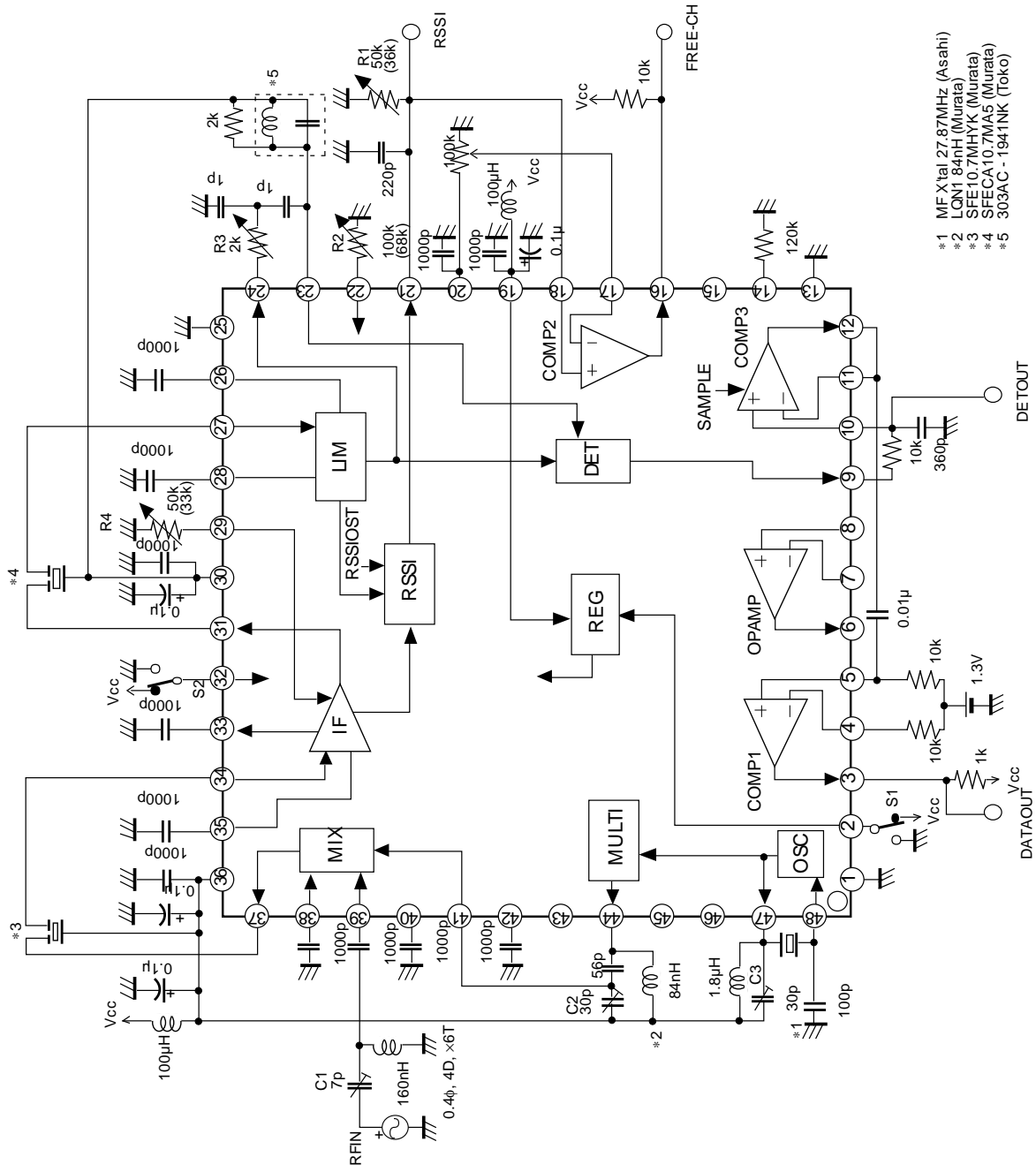

Application circuits shown are typical examples illustrating the operation of the devices. Sony cannot assume responsibility for any problems arising out of the use of these circuits or for any infringement of third party patent and other right due to same.

Mixer input characteristics and 3rd order intercept point

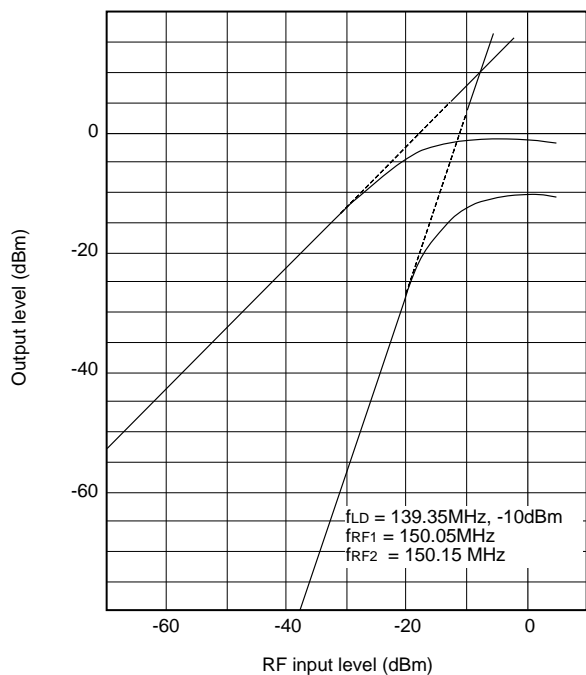

Mixer conversion gain frequency characteristics

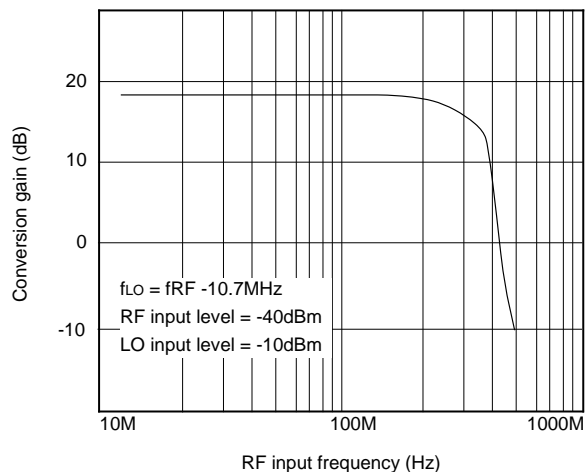

Local input level vs. Mixer conversion gain

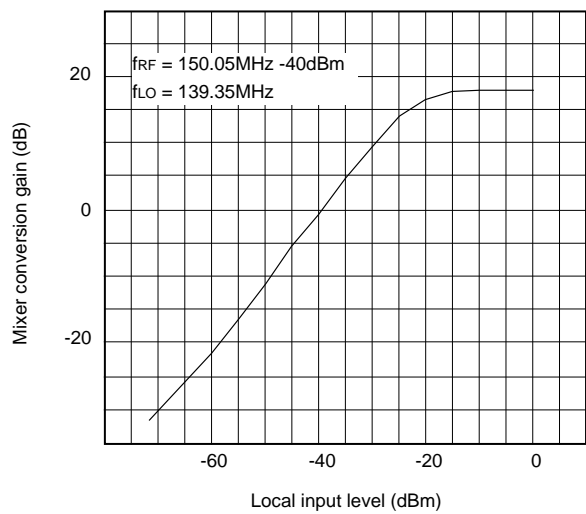

IF amplifier voltage gain frequency characteristics

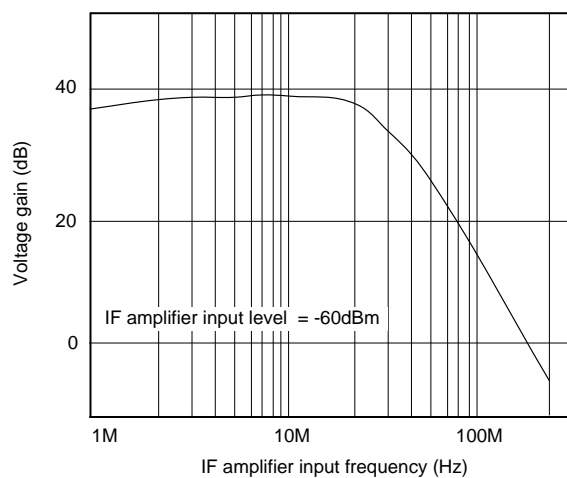

Limiter voltage gain frequency characteristics

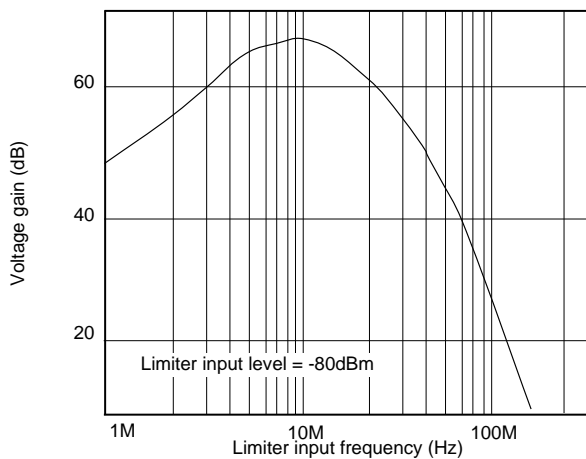

Detector output frequency characteristics

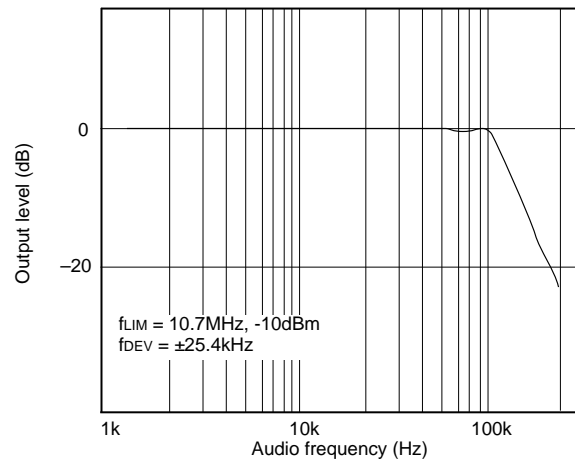

RSSI characteristics

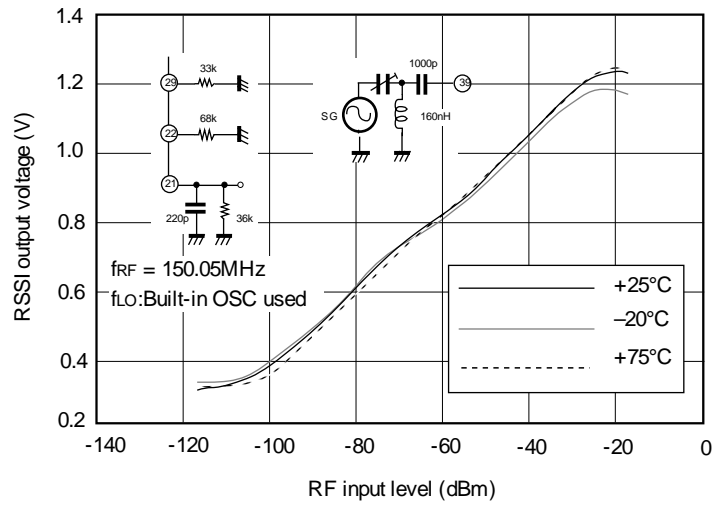

DET output characteristics

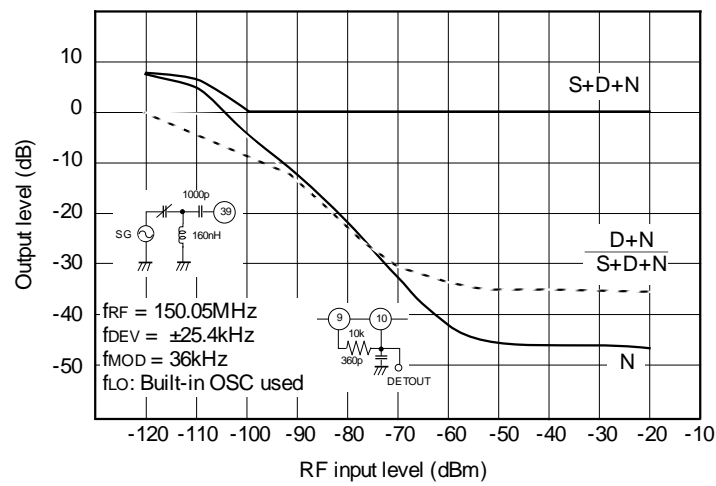

Supply voltage vs. Current consumption

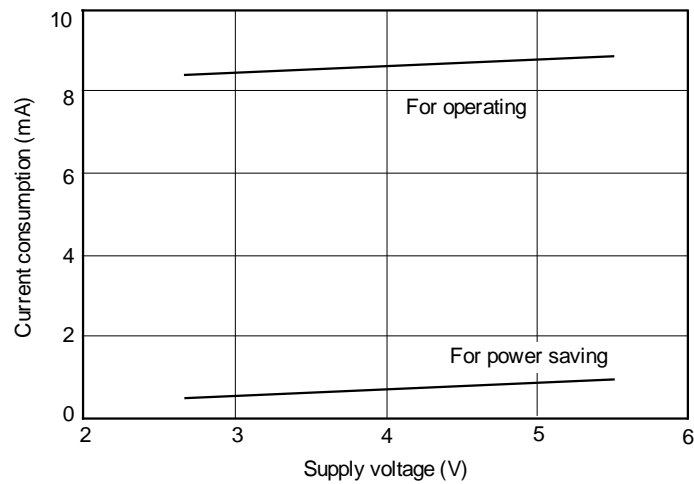

Description of Operation

- The signals which have been input from Pins 38 and 39 are mixed with the local oscillation signal from the oscillator and multiplier at the mixer, and the frequency-converted signal is output from Pin 37. The oscillator can be self-oscillated by composing the Colpitts-type crystal oscillation circuit between Pins 47 and 48. Also, the external local oscillation signal can be directly input to Pin 47.
- After the bandwidth is limited by filter, the mixer output signal is amplified by the IF amplifier and output from Pin 31. The IF amplifier output signal is limited its bandwidth again, and the amplitude is limited by the limiter amplifier and output from Pin 24. The limiter amplifier output signal is phase-shifted by LC resonance circuit and the signal is output from Pin 9 after being quadrature-detected.
- The RSSI output is the currents corresponding to the input level at the IF amplifier and limiter amplifier. The current signal can be converted into a voltage signal by connecting a proper I-V conversion circuit to Pin 21.

Notes of Operation

Take care of the followings because the CXA1744AR has the IF amplifier voltage gain of approximately 34 dB and limiter amplifier voltage gain of approximately 67 dB and uses high frequency.

1. Use as wide pattern as possible for the power supply line and GND, and insert a by-pass capacitor as close to them as possible.
2. Separate the input line from the output line as far as possible and make the wiring short.
3. Ground the decoupling capacitors of mixer (Pins 38, 40 and 42), IF amplifier (Pins 33 and 35) and limiter amplifier (Pins 26 and 28) as close to each pin as possible.

Notes on Application

1) Power supply

This IC has a built-in voltage regulator so that the supply voltage range is wide (2.7 to 5.5 V) and stable. There are three power supply pins and GND pins (Pins 19, 13 and 36, 1 and 30, 25). Ground a decoupling capacitor as close to each power supply pin as possible.

2) Oscillator

The oscillator in this IC varies its current consumption according to the oscillation level.

The figures below show how to use the CXA1744AR oscillator.

(a) Configuring a Colpitts oscillation circuit.

(b) Inputting a local oscillation signal from an external circuit.

Input a signal of approximately 0 dBm to stabilize the oscillator operation and reduce the current consumption.

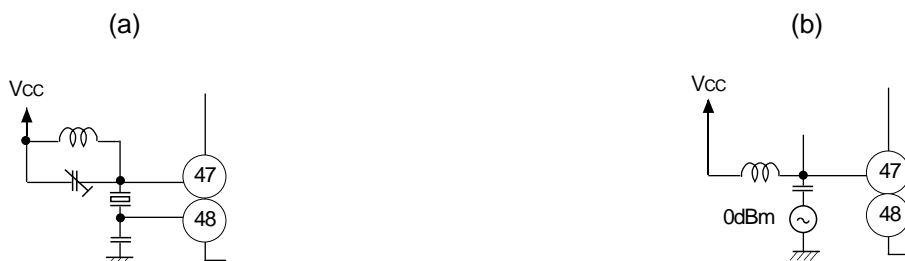

3) Multiplier

The $\times 5$ multiplier is provided in this IC for mixer local signal. The fifth-order component of the input signal is extracted by the resonance circuit connected to Pin 44 externally. Wire the resonance circuit as close to Pin 44 as possible.

4) Mixer

The CXA1744AR mixer is of double balanced type. Its input is at Pins 38 and 39; when input from Pin 39, Pin 38 should be grounded with a capacitor.

5) 10.7 MHz filter

The mixer output impedance and IF amplifier input impedance are approximately $330\ \Omega$. The IF amplifier output impedance and limiter amplifier input impedance are approximately $460\ \Omega$. Use the 10.7 MHz filter with matching.

6) Detector

For quadrature FM detection, the phase of the limiter output (Pin 24) is shifted 90° by the RLC parallel resonance circuit or discriminator as the output is input to pin 23.

The phase shifter by RLC parallel resonance circuit is shown below. In this case, values of L and C are determined so that the center frequency of the second IF signal and the parallel resonance frequency are equal. As the value of R sets the detector output level, select this value so as to obtain the required output level.

With regards to the detector input, the center frequency of the second IF signal and the frequency for the minimum value of the detector distortion does not match because the internal delay is more than the external one. Add the delay circuit as shown below to match the center frequency of the second IF signal and the frequency for the minimum value of the detector distortion.

 Delay circuit

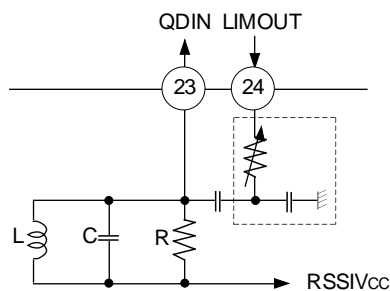

7) RSSI

RSSI detects the input signal level, and the current is output in this IC. If the voltage output is necessary, I-V conversion should be made by use of a resistor, etc.

This IC can compensate for the unevenness of the filter connected between the IF amplifier and limiter amplifier. Pin 29 is used to perform the adjustment so that the line of the RSSI output characteristics is as straight as possible.

Also, RSSI offset adjustment pin (Pin 22) is provided in this IC. For example, the RSSI offset amount is adjusted to match the dynamic range used in the next-stage IC.

8) Comparator

This IC has three comparators and they are designed according to the following applications.

COMP1 performs the waveform shaping of the demodulated audio signal and outputs the resulting signal as a rectangular wave.

COMP2 is used to detect the free channel or the signal strength after the RSSI output voltage is input.

COMP3 is the current output-type comparator. The COMP3 output can be turned ON/OFF by setting Pin 32 High/Low and this comparator can form a part of a sample-and-hold circuit. The rise time of the demodulated signal during burst operating can be shortened.

9) PSX

This is the power save control pin (Pin 2). The power save function is performed by setting this pin Low; the functional blocks except OSC are in the power save mode.

Package Outline Unit : mm

48PIN LQFP (PLASTIC)

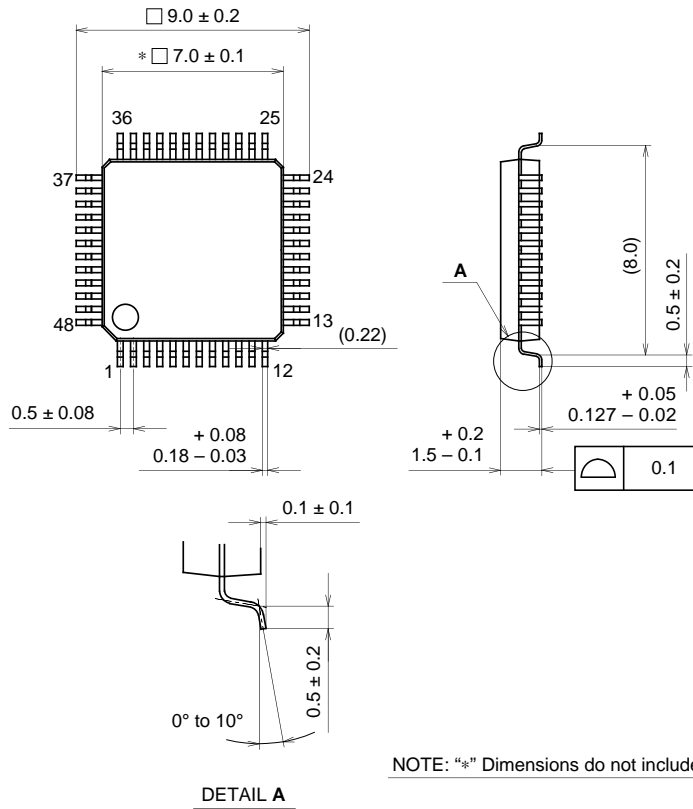

SONY CODE	LQFP-48P-L01
EIAJ CODE	QFP048-P-0707
JEDEC CODE	_____

PACKAGE STRUCTURE

PACKAGE MATERIAL	EPOXY / PHENOL RESIN
LEAD TREATMENT	SOLDER/PALLADIUM PLATING
LEAD MATERIAL	42/COPPER ALLOY
PACKAGE WEIGHT	0.2g