

Encoder for CCD Color Camera

Description

The CXA1592Q/R is a bipolar IC developed as an encoder for CCD color cameras.

Color difference and luminance signals are input to be output as composite video and Y/C separate signals.

The CXA1592 is a variant of the CXA1392 in which the down/up ratio and level of sharpness signal have been changed from 1 : 3 to 1.5 : 1.5.

Features

- Carrier balance adjustment unnecessary (Carrier leak above 36 dB against burst)
- High S/N
- Low power consumption (140mW)

Applications

CCD camera

Absolute Maximum Ratings (Ta = 25°C)

- Supply voltage Vcc 7 V
- Storage temperature Tstg -65 to +150 °C
- Allowable power dissipation Pd 600 mW

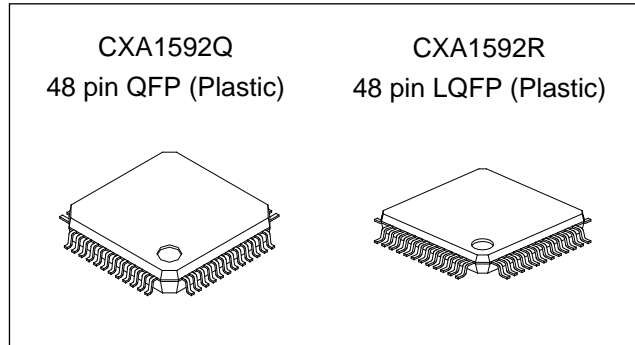

Structure

Bipolar silicon monolithic IC

Operating Conditions

- Supply voltage Vcc 4.75 to 5.25 V
- Ambient temperature Topr -20 to +75 °C

Block Diagram and Pin Configuration

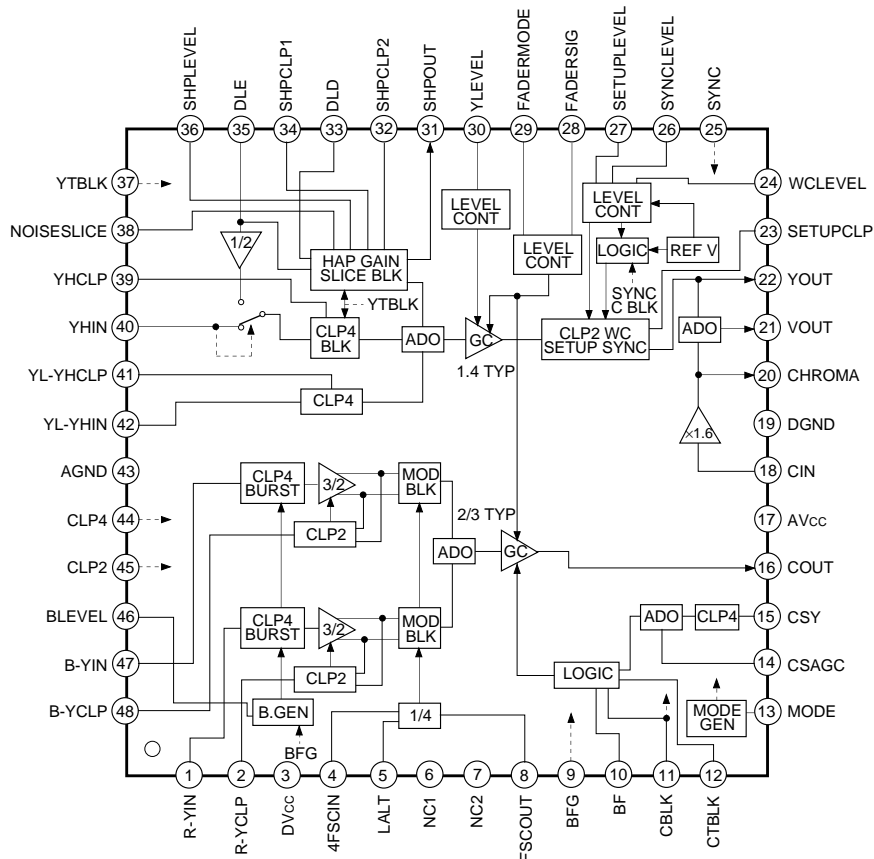

Sony reserves the right to change products and specifications without prior notice. This information does not convey any license by any implication or otherwise under any patents or other right. Application circuits shown, if any, are typical examples illustrating the operation of the devices. Sony cannot assume responsibility for any problems arising out of the use of these circuits.

Pin Description

Pin No.	Symbol	Pin voltage	Equivalent circuit	Description
1	R-Y IN	3V		R-Y signal input pin. Clamped internally through C cut input.
2	R-Y CLP	3.4V		Pin connecting the capacitor for R-Y modulator clamp. Setting the capacitance to too small a value will enlarge the carrier leak. 0.1µF and above is recommended.
3	DVcc	5V		Power supply pin for the 1/4 counter block.
4	4FSCIN	14.32MHz 1Vp-p DC 2.5V		Input pin for the 4FSC used to make up the Sub Carrier. Input through C cut. Set amplitude to over 500mVp-p.
5	LALT	0V		Input pin for Line Alternate signal during PAL mode. V_{TH} is at 2.5V. Input a pulse with an amplitude larger than $V_{TH} \pm 0.5V$. Set to GND during NTSC mode.

Pin No.	Symbol	Pin voltage	Equivalent circuit	Description
6	NC1	—		Not for use. Keep open
7	NC2	—		Not for use. Keep open.
8	FSCOUT	5V		Outputs a sub carrier with the same phase as B-Y. When not in use, connection to Vcc prevents output and allows for 600µA of current saving. Determining phase to 4FSC is impossible.
9	BFG			<p>Inserts a pulse slightly larger than BF on both ends.</p> <p>V_{TH} is at 2.5V. Input a pulse with an amplitude larger than $V_{TH} \pm 0.5V$.</p>
10	BF			<p>Inputs BF (burst flag) pulse. During analog burst, the input pulse smoothens the waveform. The input pulse waveform becomes the envelope of the analog burst waveform.</p> <p>During the usual burst, be sure to input the pulse.</p>
11	CBLK			<p>Inputs CBLK (composite blanking) pulse. V_{TH} is at 2.5V. Input a pulse with an amplitude larger than $V_{TH} \pm 0.5V$.</p>

Pin No.	Symbol	Pin voltage	Equivalent circuit	Description
12	CTBLK	5V 0V		<p>Inputs CT (chroma titler) pulse. This signal prevents the application of chroma suppress during the titler signal period. V_{TH} is at 2.5V. Input a pulse with an amplitude larger than $V_{TH} \pm 0.5V$.</p>
13	MODE	0V		<p>Selected NTSC, PAL or NTSC $\times 2$, PAL $\times 2$ modes. 0V : NTSC $\times 1$ Normal burst 2.5V: NTSC $\times 2$ Analog burst 3.5V: PAL $\times 2$ Analog burst 5V : PAL $\times 1$ Normal burst</p>
14	CSAGC	0V		<p>Suppresses chroma signal at the AGC gain control signal. 3V (100%) to 4.2V (50%)</p>
15	CSY	2.4V		<p>Suppresses chroma signal at the Y signal. 200mV (100%) to 700mV (0%) Inputs at C cut. Clamped internally.</p>
16	COUT	2.8V		<p>Chroma signal output pin. Output as rectangular waves.</p>

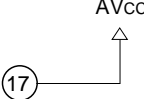
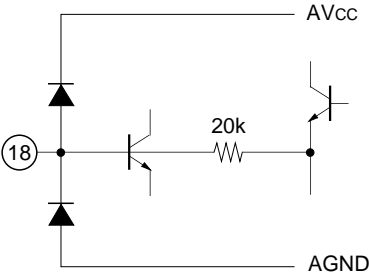
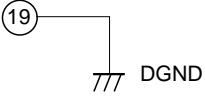
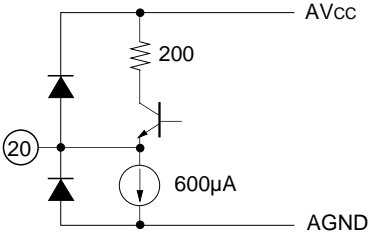
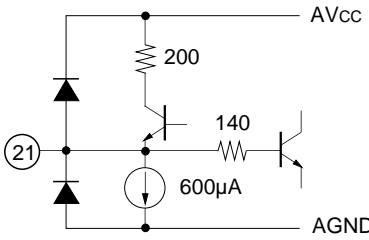
Pin No.	Symbol	Pin voltage	Equivalent circuit	Description
17	AVcc	5V		Power supply pin for other than 1/4 counter block.
18	CIN	2.5V		Input pin for chroma signal passed through BPF. Internally biased with a 20kΩ resistance. Input at C cut.
19	DGND	0V		GND pin for 1/4 counter block.
20	CHROMA	2V		Signals input from CIN are amplified and output through this pin. Chroma signal output pin when used for Y/C separation output.
21	VOUT	1.8V		Output pin of composite video signal. When not in use, connection to Vcc allows for 900µA of current saving.

Pin No.	Symbol	Pin voltage	Equivalent circuit	Description
22	YOUT	2.4V		Y signal output pin when used for Y/C separation output.
23	SETUPCLP	3.3V		Connecting pin for the white clip clamp capacitor. Over 0.1μF is recommended.
24	WC LEVEL	3.4V		White clip level control pin. 1.6V (550mV) to 5V (1110mV)
25	SYNC			Sync pulse input pin. V_{TH} is at 2.5V. Input a pulse with an amplitude larger than $V_{TH} \pm 0.5V$.
26	SYNC LEVEL	0V		Sync level control pin. 1.6V (180mV) to 5V (380mV) 0V (287mV) preset.

Pin No.	Symbol	Pin voltage	Equivalent circuit	Description
27	SETUP LEVEL	3.5V		Set up level control pin. 2.4V (0mV) to 5V (120mV)
28	FADER SIG	0V		Controls the signal suppress level during Black Fader. Controls the signal suppress level during White Fader and at the same time controls the set up level. Signal suppress control: 2V (100%) to 2.9V (0%) Set up level control: 2V (0%) to 2.9V (100%) Black Fader/White Fader mode selection executed through Fader Mode pin.
29	FADER MODE	3.5V		Black Fader and White Fader mode select pin. Also controls the final value (100%) of White Fader white level (set up level). 0V (Black Fader) 1.8V (100mV) to 5V (630mV) (White Fader)
30	Y LEVEL	3.4V		Y signal level control pin. 1.6V (-3.5dB) to 5V (9dB)
31	SHP OUT	3V		Aperture signal output pin. When not in use, connection to Vcc allows for 700μA of current saving.

Pin No.	Symbol	Pin voltage	Equivalent circuit	Description
32	SHPCLP2	3.2V		Connects the clamp capacitor used for the slice of the aperture signal.
33	DLD	2.1V		Connects the delay line drive side of the aperture signal.
34	SHPCLP1	3.2V		Connects the clamp capacitor used for the slice of the aperture signal.
35	DLE	2.1V		Connects the delay line end side of the aperture signal. When this pin signals are used as Y _H signals, Y _H IN pin is connected to V _{cc} .
36	SHP LEVEL	3.5V		Control pin of the aperture signal level. 2.6V (8dB) to 4.2V (-31dB)

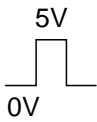
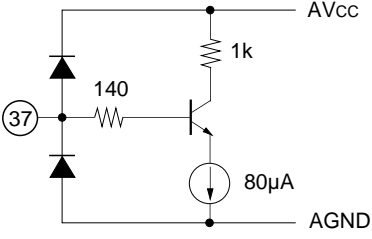
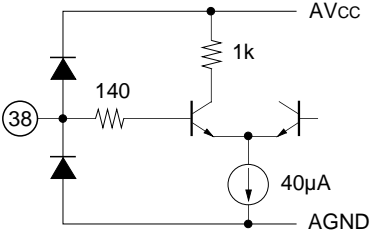
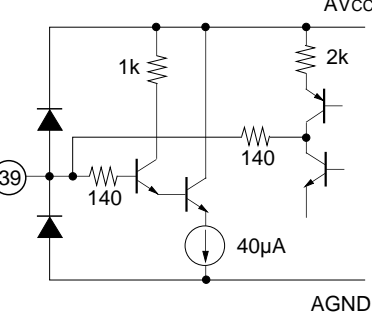
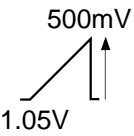
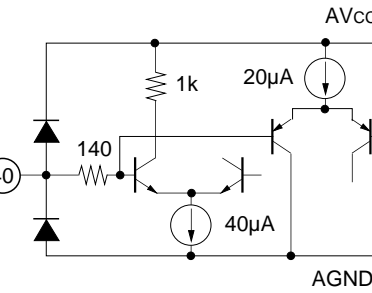
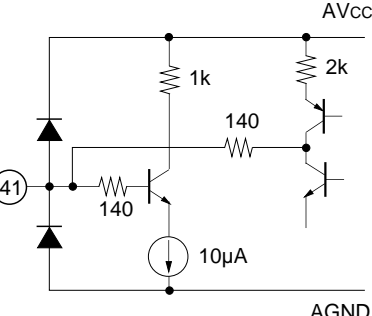
Pin No.	Symbol	Pin voltage	Equivalent circuit	Description
37	YTBLK	 5V 0V		Inputs Y_T (Y titler) pulse. V_{TH} is at 2.5V. Input a pulse with an amplitude larger than $V_{TH} \pm 0.5V$.
38	NOISESLICE	3.5V		Controls the slice level of the aperture signal. 1.8V (0mV) to 5V (75mV)
39	YHCLP	2.7V		Connects the capacitor for Y_H input clamp.
40	YHIN	 500mV 1.05V		Y_H signal input pin. When DLE pin signal is set as Y_H signal, connect this pin to V_{CC} . The input signal DC clamp range stands at $1.05V \pm 0.65V$. The standard signal level is at 500mV.
41	YL-YHCLP	3.4V		Connects the capacitor for Y_L - Y_H input clamp.

Pin No.	Symbol	Pin voltage	Equivalent circuit	Description
42	YL-YH IN	2.8V		<p>Inputs V aperture signals, titler signals and YL-YH signals. The input signal DC clamp range stands at $2.8V \pm 1.1V$.</p>
43	AGND	0V		<p>GND pin for other than 1/4 counter block.</p>
44	CLP4			<p>CLP4 pulse input pin. V_{TH} is at 2.5V. Input a pulse with an amplitude larger than $V_{TH} \pm 0.5V$.</p>
45	CLP2			<p>CLP2 pulse input pin. V_{TH} is at 2.5V. Input a pulse with an amplitude larger than $V_{TH} \pm 0.5V$.</p>
46	B LEVEL	3.5V		<p>Controls the burst level. 1.6V (95mVp-p) to 5V (280mVp-p) (NTSC pulse burst mode)</p>

Pin No.	Symbol	Pin voltage	Equivalent circuit	Description
47	B-Y IN	3V		<p>B-Y signal input pin. Clamped internally through C cut input.</p>
48	B-Y CLP	3.4V		<p>Connects the capacitor for B-Y modulator clamp. Setting the capacitance to too small a value will enlarge the carrier leak. Over 0.1µF is recommended.</p>

Electrical Characteristics

(V_{CC} = 5V, T_a = 25°C)

No.	Item	Symbol	Conditions	Min.	Typ.	Max.	Unit
1	Current Supply	I _{CC}	AV _{CC} + DV _{CC}	19	28	38	mA
2	YH GAIN TYP	YHTYP	FSCOUT = 5V VOUT = 5V SHPOUT = 5V YHIN (500mV pulse) → YOUT	1.8	2.8	3.8	dB
3	YH GAIN MIN	YHMIN	YHIN (500mV pulse) → YOUT YLEVEL = 1.6V	—	-4	-2	dB
4	YH GAIN MAX	YHMAX	YHIN (250mV pulse) → YOUT YLEVEL = 5V	8	9.1	—	dB
5	YL-YH GAIN	YL-YH	YL-YHIN (500mV pulse) → YOUT	1.8	2.8	3.8	dB
6	DLE GAIN	DLE	DLE (1V pulse) → YOUT YHIN = 5V	-4.3	-3.3	-2.3	dB
7	VOUT GAIN	VOUT	YHIN (500mV pulse) → VOUT	1.3	2.3	3.3	dB
8	WHITE FADER MIN	WFMIN	CBLK pulse FADERMODE = 1.6V WFMIN = YOUT output level - SETMAX (No.13)	68	86	104	mV
9	WHITE FADER MAX	WFMAX	CBLK pulse FADERMODE = 5V WFMAX = YOUT output level - SETMAX (No.13)	527	620	713	mV
10	WHITE CLIP MIN	WCMIN	YHIN (500mV pulse) → YOUT CBLK pulse WCLEVEL = 1.6V	522	550	578	mV
11	WHITE CLIP MAX	WCMAX	YHIN (500mV pulse) → YOUT CBLK pulse WCLEVEL = 5V	1056	1112	1168	mV
12	WHITE CLIP PRESET	WCPRE	YHIN (500mV pulse) → YOUT CBLK pulse WCLEVEL = 0V	796	838	880	mV
13	SETUP MAX	SETMAX	CBLK pulse → YOUT SETUPLEVEL = 5V	113	126	139	mV
14	SYNC MIN	SYNCPRE	SYNC pulse → YOUT SYNCLEVEL = 1.6V	165	180	195	mV
15	SYNC MAX	SYNCPRE	SYNC pulse → YOUT SYNCLEVEL = 5V	363	383	403	mV
16	SYNC PRESET	SYNCPRE	SYNC pulse → YOUT SYNCLEVEL = 0V	272	287	302	mV
17	SHP-YOUT GAIN	SHPYOUT	DLD (40mV pulse) → YOUT SHPLEVEL = 2.6V YHIN (500mV pulse)	6	8	10	dB
18	SHP DOWN MIN	SHPMIN	DLD (40mV pulse) → SHPOUT SHPLEVEL = 4.2V	—	-25	-5.5	dB
19	SHP DOWN TYP	SHPTYP	DLD (40mV pulse) → SHPOUT SHPLEVEL = 3.4V	-0.5	1	2.5	dB
20	SHP DOWN MAX	SHPMAX	DLD (40mV pulse) → SHPOUT... (DOWNMAX) SHPLEVEL = 2.6V	5.7	7.2	8.7	dB
21	SHP DOWN/UP	SHPD/U	DLD (40mV pulse) → SHPOUT... (UPMAX) SHPLEVEL = 2.6V SHPD/U=DOWNMAX/UPMAX	0.8	1	1.2	times
22	SHP SLICE MAX	SLICEMAX	DLD (40mV pulse) → SHPOUT... (SLMAX) SHPLEVEL = 2.6V NOISESLICE = 0V SLICEMAX = DOWNMAX-SLMAX	60	75	90	mV
23	B-Y GAIN	B-Y	B-YIN (300mV pulse) → BPFOUT 4FSCIN = SIN 1Vp-p 14.32MHz B-Y = 20log {BPFOUT (mVp-p)/300mV}	0.4	1.6	2.8	dB

No.	Item	Symbol	Conditions	Min.	Typ.	Max.	Unit
24	R-Y GAIN	R-Y	R-YIN (300mV pulse) → BPFOUT ... (R-Y level) 4FSCIN = SIN 1Vp-p 14.32MHz R-Y=20log {BPFOUT (mVp-p)/300mV}	0.4	1.6	2.8	dB
25	CARRIER LEAK 3.58MHz	L358	4FSCIN = SIN 1Vp-p 14.32MHz L358 = 20log {286mVp-p/BPFOUT level (mVp-p)} BURST (Typ.)	36	48	—	dB
26	CARRIER LEAK 500kHz	L500	4FSCIN = SIN 1Vp-p 2MHz L500 = 20log {286mVp-p/BPFOUT level (mVp-p)} BURST (Typ.)	36	58	—	dB
27	COUT DRANGE	COU_TD	R-YIN (600mV pulse) → BPFOUT 4FSCIN = SIN 1Vp-p 14.32MHz	670	730	—	mV
28	CS AGC MAX	CSAGC_MAX	R-YIN (300mV pulse) → BPFOUT 4FSCIN = SIN 1Vp-p 14.32MHz CSAGC = 4.2V CSAGC_MAX = (BPFOUT level/ R-Y level) × 100%	47	52	57	%
29	FSCOUT amplitude	FSC	FSCOUT DC amplitude at 4FSCIN = 2V, 3V	585	673	760	mV
30	BURST NTSC MIN	NTMIN	BFG pulse → BPFOUT BLEVEL=1.6V 4FSCIN = SIN 1Vp-p 14.32MHz	80	95	110	mV
31	BURST NTSC MAX	NTMAX	BFG pulse → BPFOUT BLEVEL=5V 4FSCIN = SIN 1Vp-p 14.32MHz	250	280	312	mV
32	BURST PAL MIN	PALMIN	BFG pulse → BPFOUT BLEVEL = 1.6V MODE = 5V 4FSCIN = SIN 1Vp-p 14.32MHz	89	105	120	mV
33	BURST PAL MAX	PALMAX	BFG pulse → BPFOUT BLEVEL = 5V MODE = 5V 4FSCIN = SIN 1Vp-p 14.32MHz	283	316	350	mV
34	BURST NTSC x 2 MIN	NT2MIN	BFG pulse → BPFOUT BLEVEL = 1.6V MODE = 2.5V 4FSCIN = SIN 1Vp-p 14.32MHz	153	180	207	mV
35	BURST NTSC x 2 MAX	NT2MAX	BFG pulse → BPFOUT BLEVEL = 5V MODE = 2.5V 4FSCIN = SIN 1Vp-p 14.32MHz	468	520	572	mV
36	BURST PAL x 2 MIN	PAL2MIN	BFG pulse → BPFOUT BLEVEL = 1.6V MODE = 3.5V 4FSCIN = SIN 1Vp-p 14.32MHz	171	202	232	mV
37	BURST PAL x 2 MAX	PAL2MAX	BFG pulse → BPFOUT BLEVEL = 5V MODE = 3.5V 4FSCIN = SIN 1Vp-p 14.32MHz	535	595	655	mV
38	CIN-VOUT GAIN	CINVOUT	CIN (SIN 400mVp-p 3.58MHz) → VOUT	2.5	3.5	4.5	dB
39	CIN-CHROMA GAIN	CINCHROMA	CIN (SIN 400mVp-p 3.58MHz) → CHROMA	2.1	3.1	4.1	dB

Ref.) YHIN → Y OUT Frequency characteristics gain 10MHz, -2.3dB (Typ.)

Test Circuit

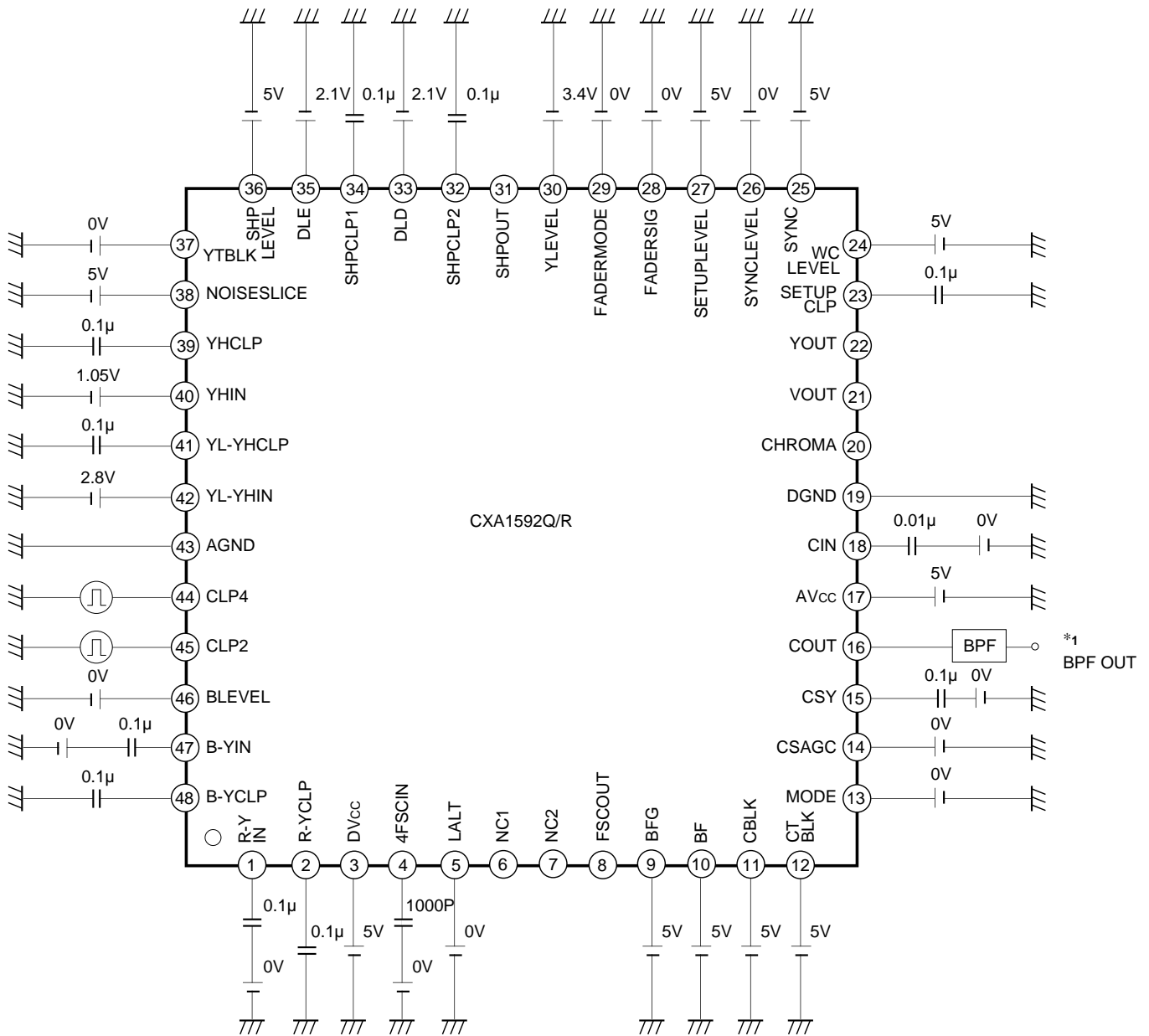

Above conditions are given as the typical setting. The individual conditions of each item are indicated in the chart.

*1 For BPF characteristics proceed as follows.

- (1) When 4FSC IN = 14.32MHz use a 3.58MHz band pass filter where through the input of a 3.58MHz sine wave a ratio of 2 to 1 is obtained for the input vs. output.
- (2) When 4FSC IN = 2MHz use a 500kHz band pass filter where through the input of a 500kHz sine wave a ratio of 2 to 1 is obtained for the input vs. output.

Input Signal Timing Chart

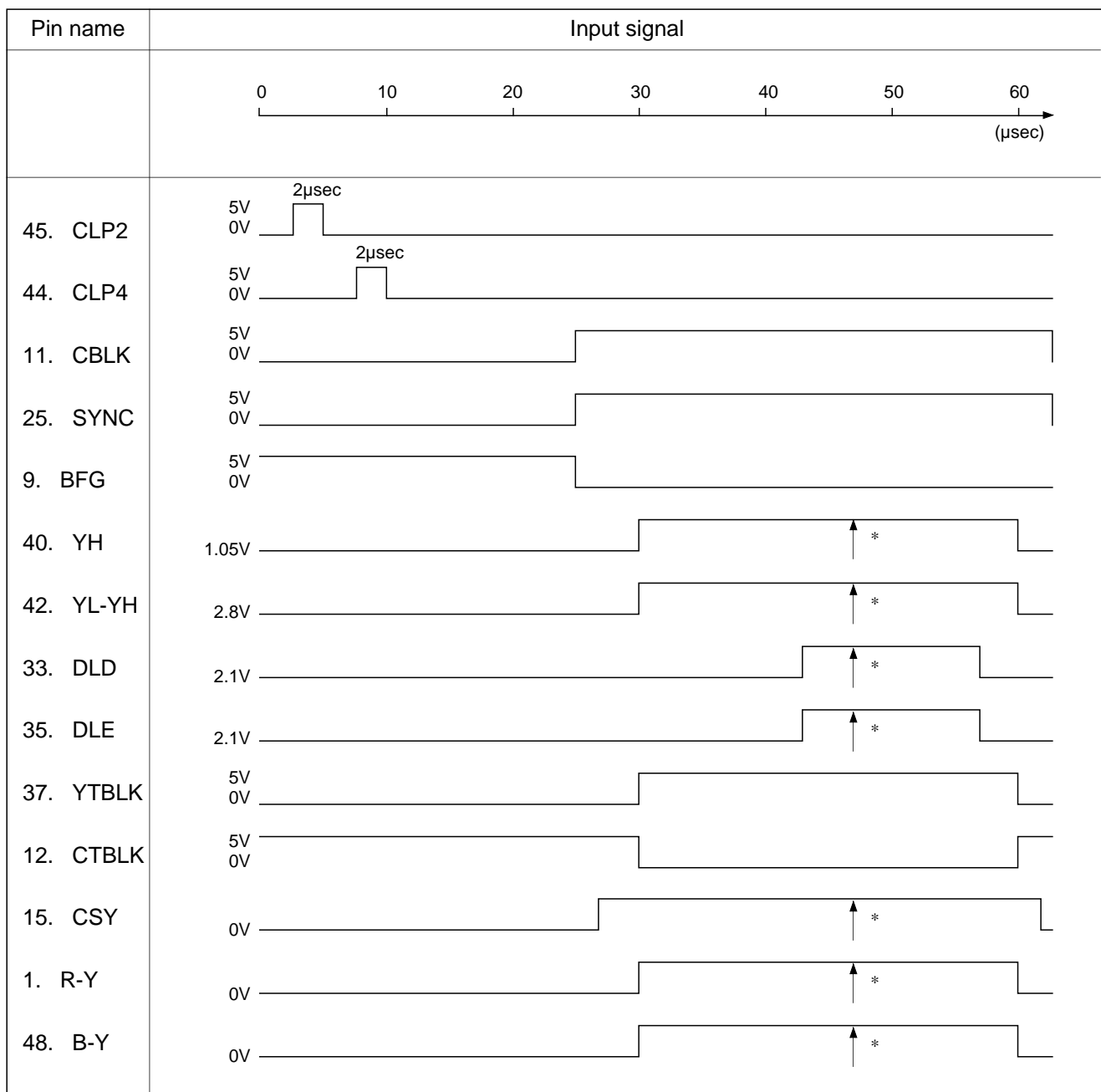

Note) Level is indicated in the conditions shown in the chart.

YH Gain control characteristics

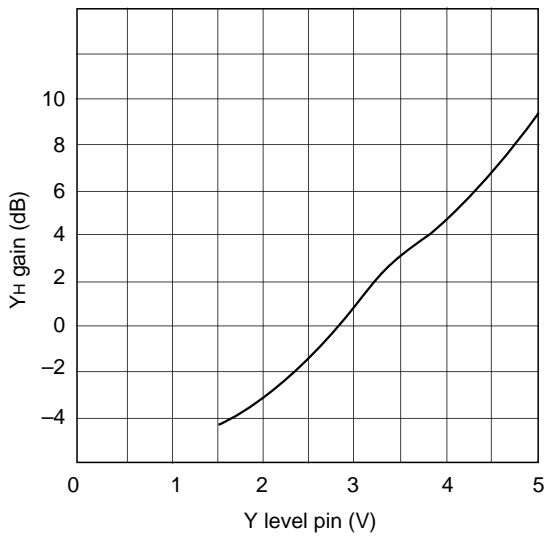

Y fader control characteristics

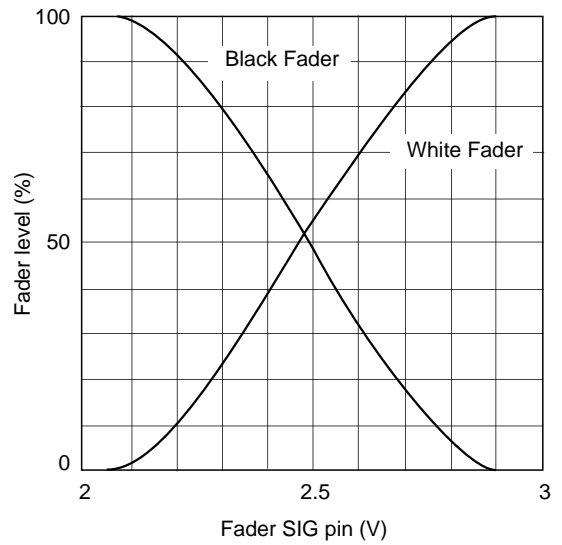

White fader control characteristics

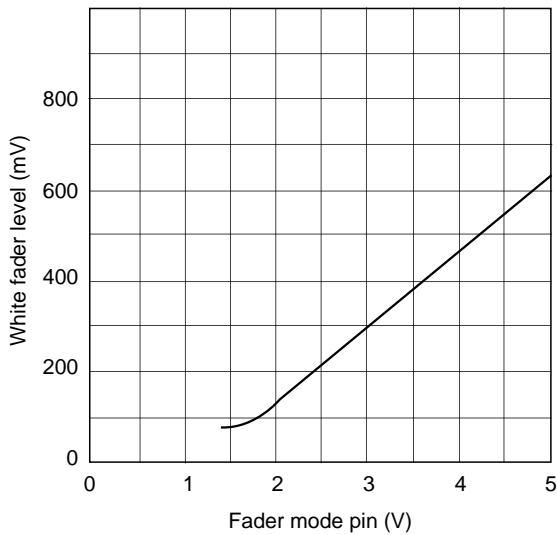

White clip control characteristics

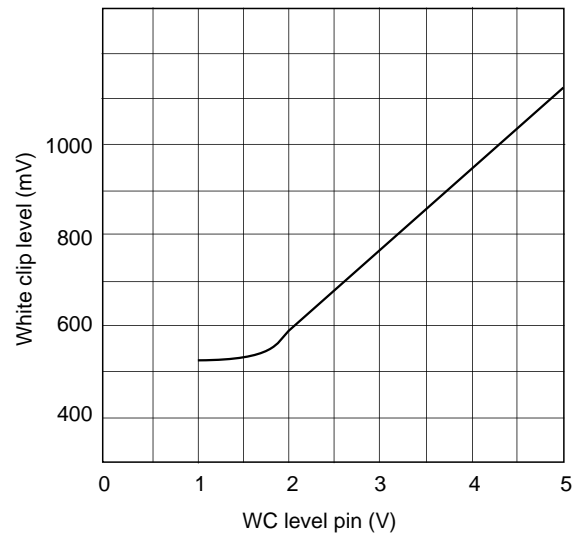

Set up level control characteristics

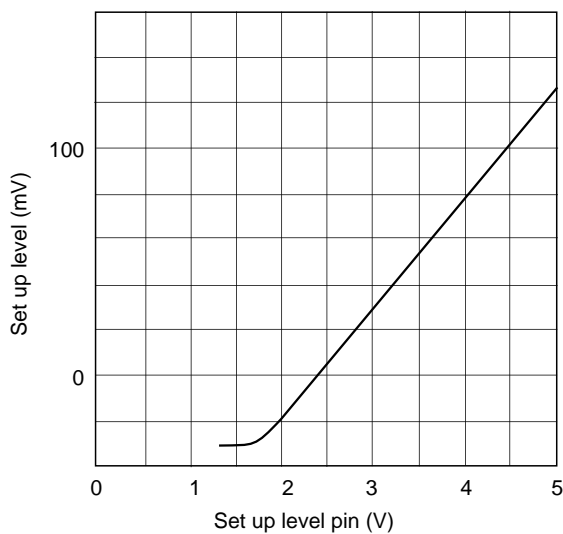

Sync level control characteristics

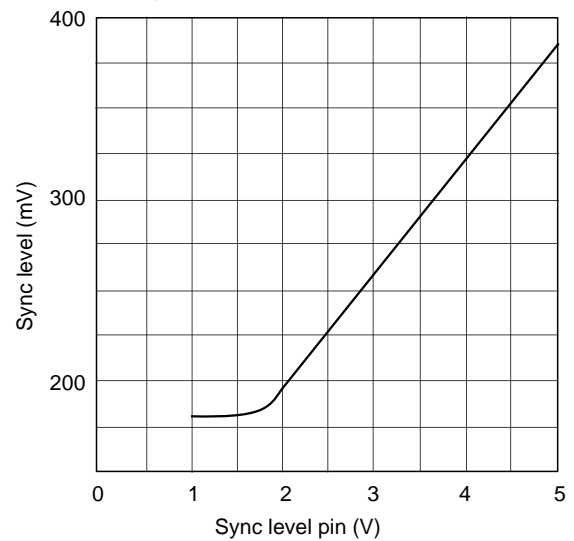

SHP gain control characteristics

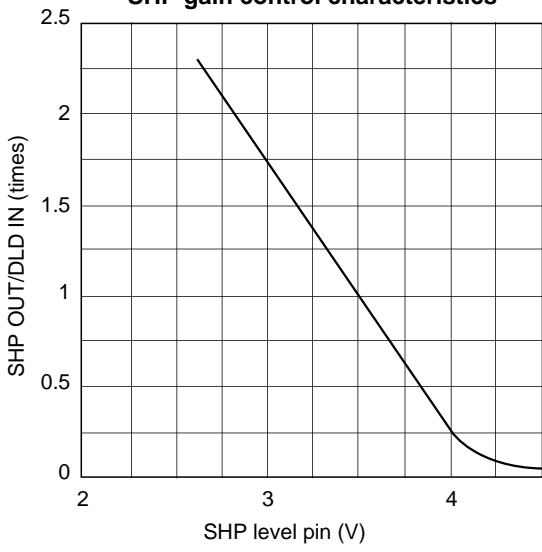

SHP noise slice characteristics

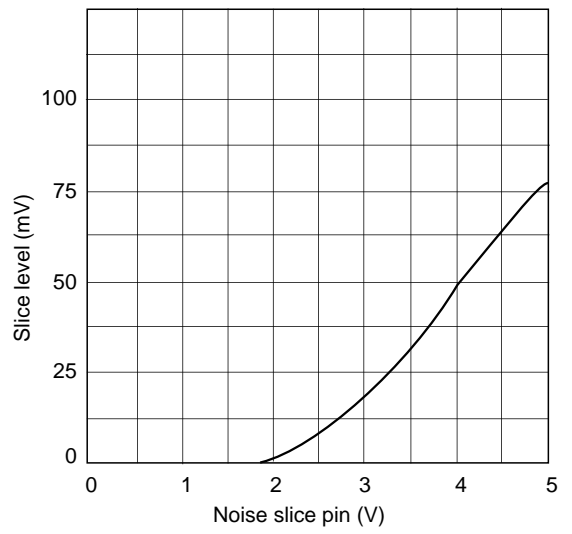

CS AGC control characteristics

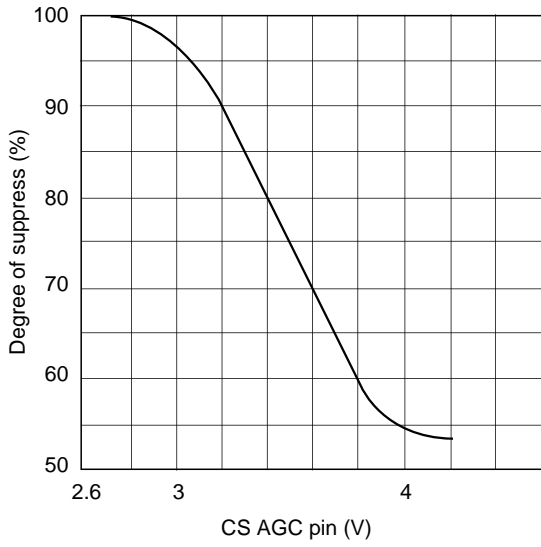

CS Y control characteristics

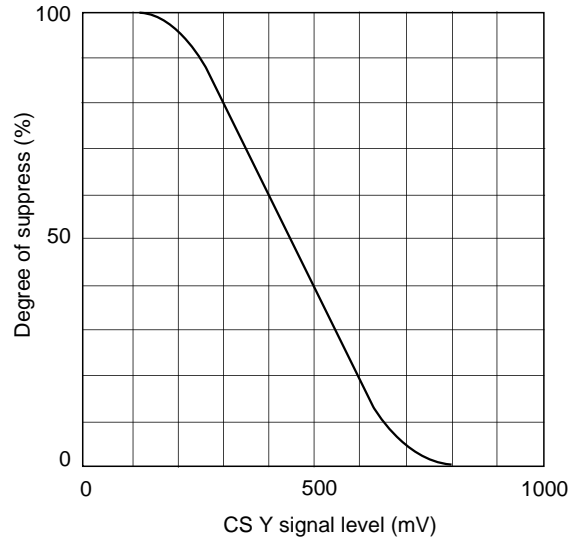

Chroma fader control characteristics

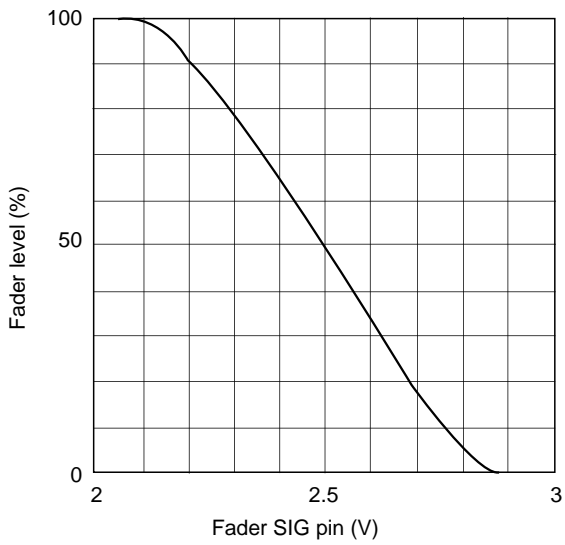

**Burst level control characteristics
(NTSC pulse mode)**

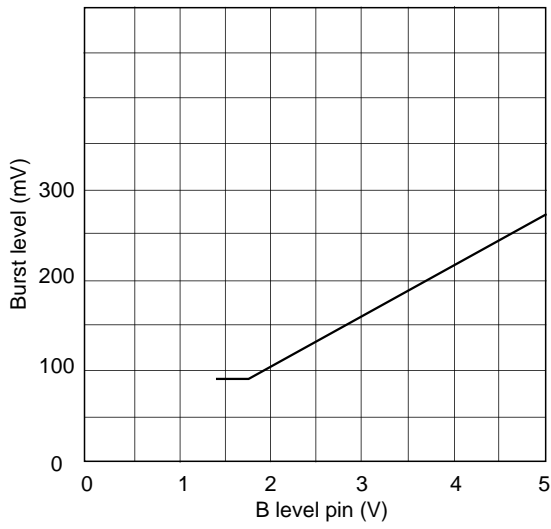

**Burst level control characteristics
(PAL pulse mode)**

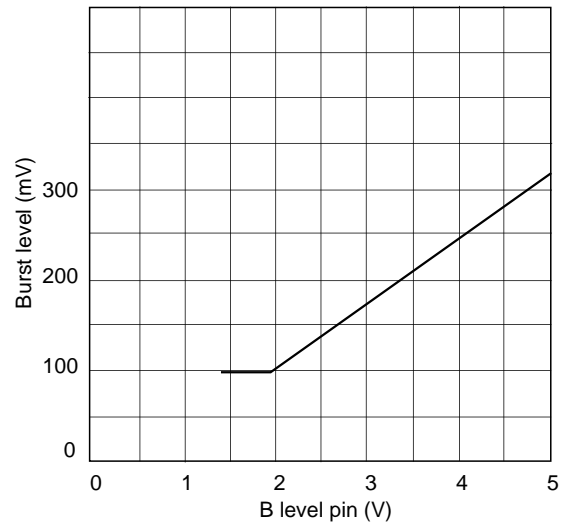

**Burst level control characteristics
(NTSC analog mode)**

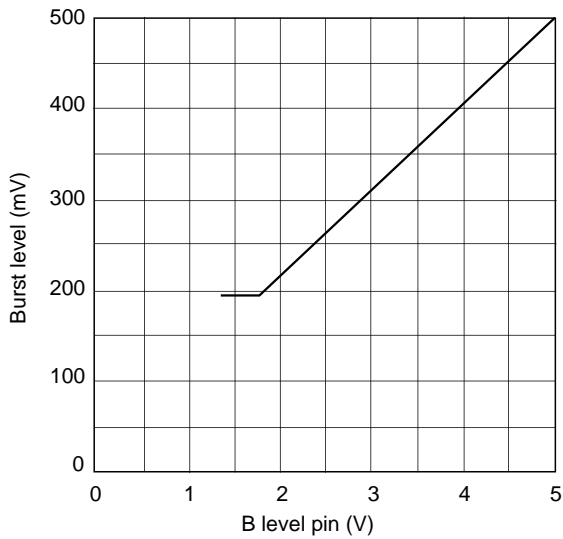

**Burst level control characteristics
(PAL analog mode)**

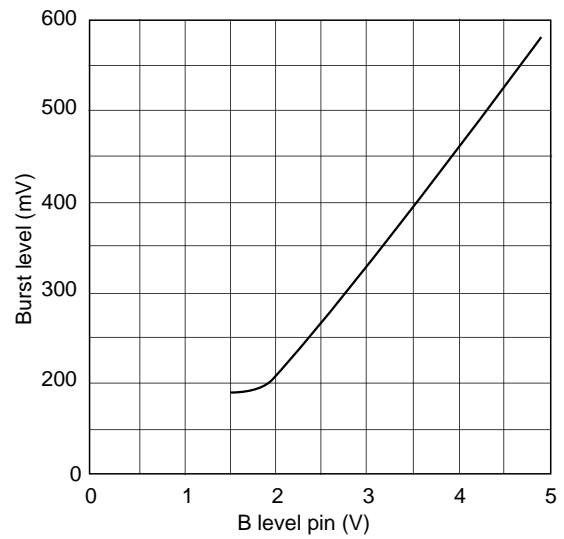

Analog burst control

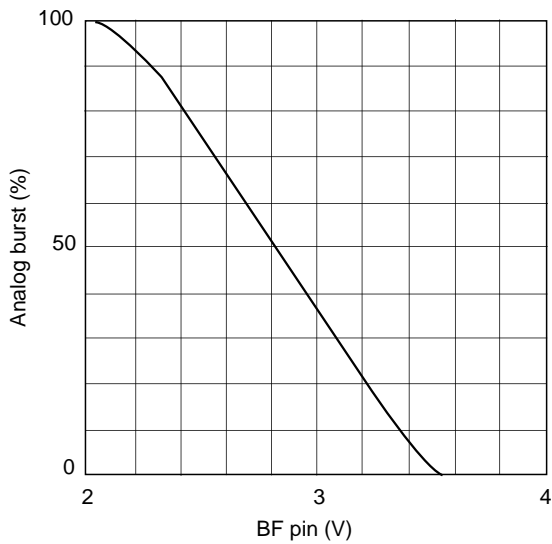

YH gain typical temperature characteristics

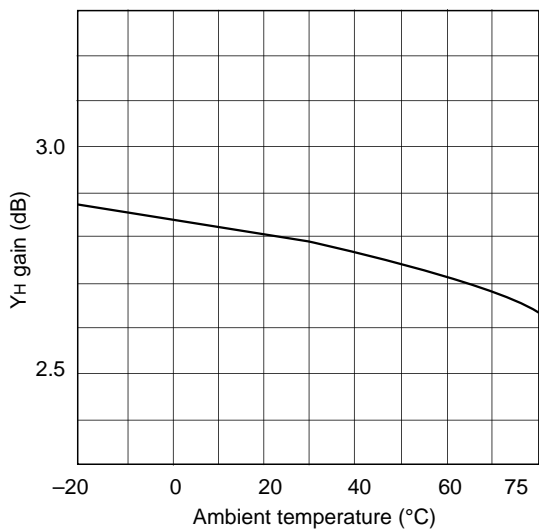

White clip preset temperature characteristics

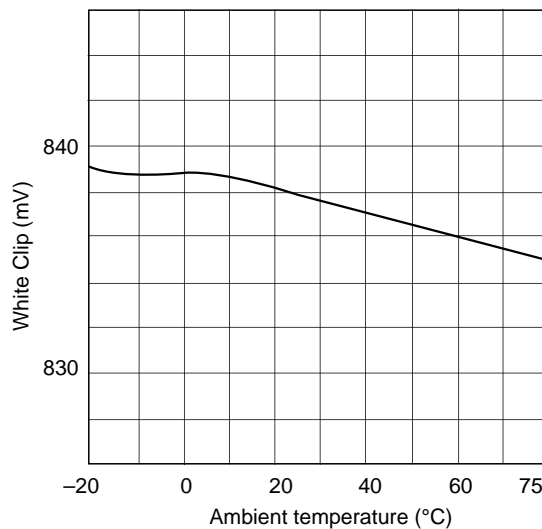

**Set up level temperature characteristics
(Set up level = 3.4V)**

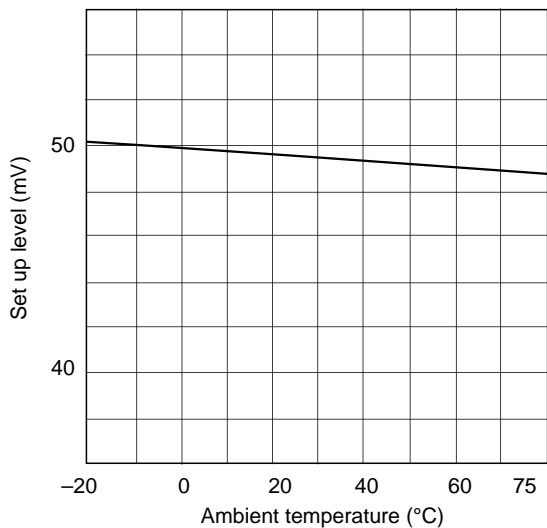

Y OUT DC temperature characteristics

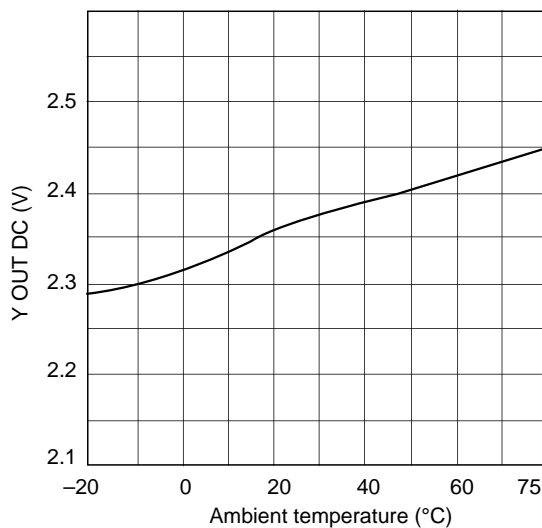

B-Y gain temperature characteristics

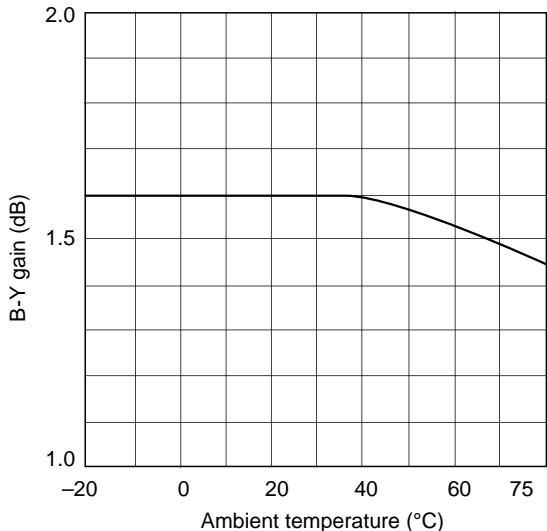

**Burst NTSC maximum temperature characteristics
(NTSC pulse mode) Burst level = 5.0V**

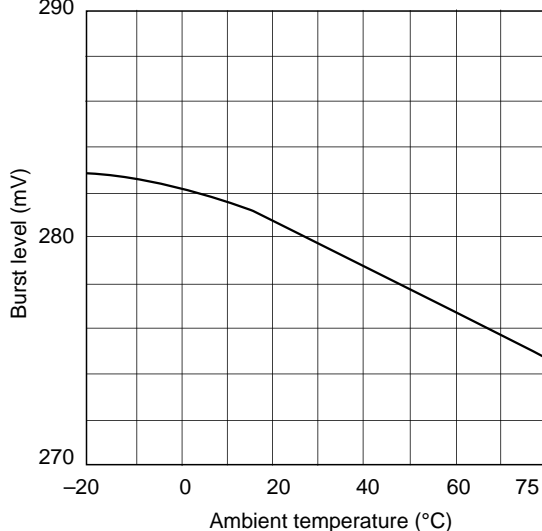

CIN → Chroma gain temperature characteristics

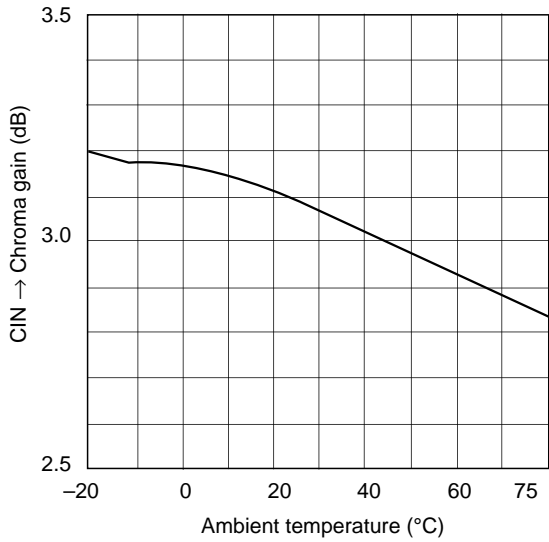

Carrier leak 3.58MHz temperature characteristics

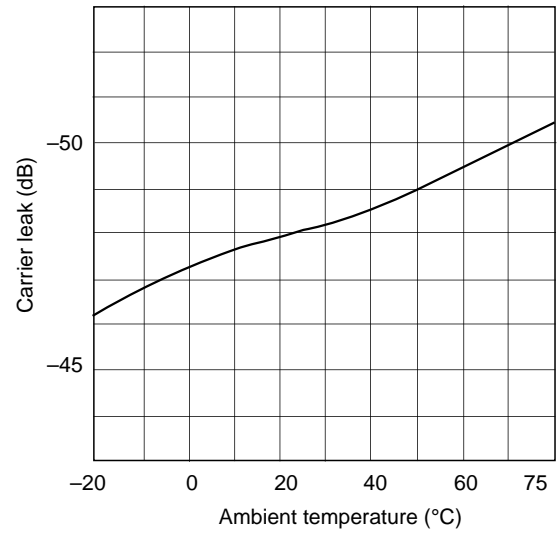

Carrier leak 500kHz temperature characteristics

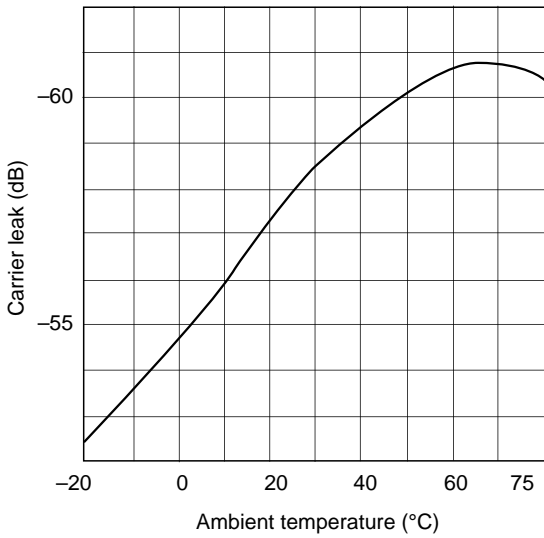

YH gain maximum supply voltage characteristics

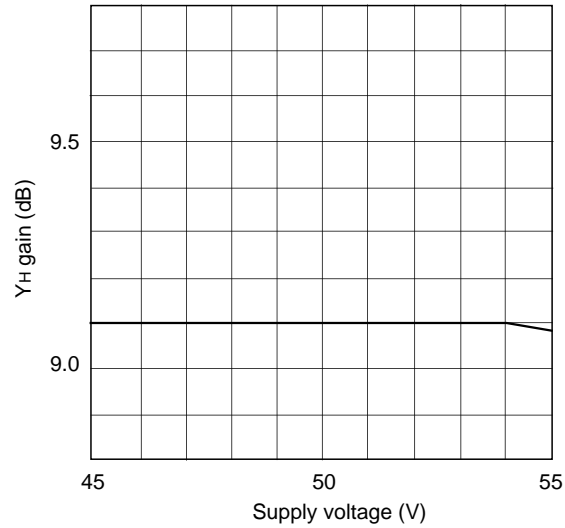

White clip preset supply voltage characteristics

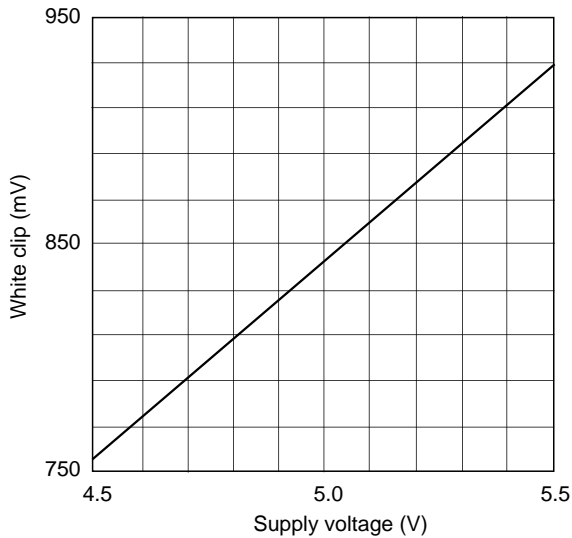

**Set up level supply voltage characteristics
(Set up level = 3.4/5 Vcc)**

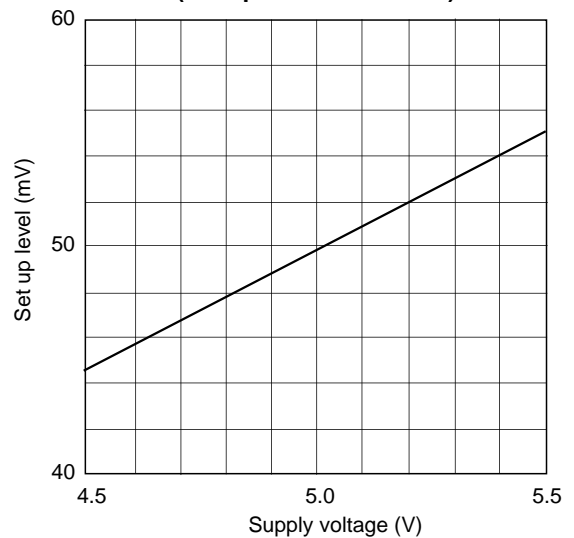

Sync level preset supply voltage characteristics

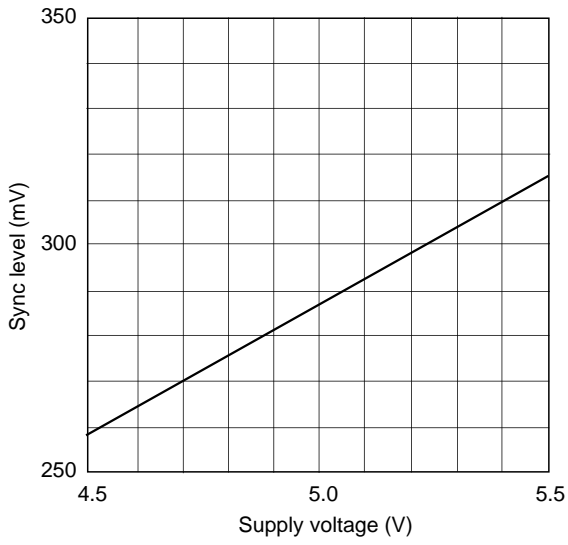

B-Y gain supply voltage characteristics

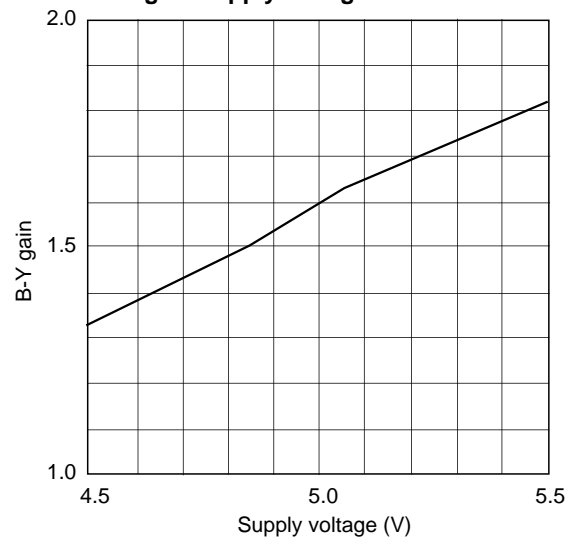

**Burst level supply voltage characteristics
(NTSC pulse mode) Burst level = Vcc**

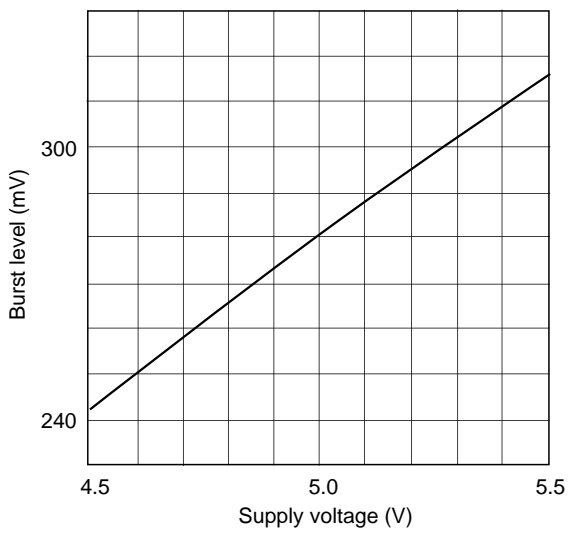

CIN → Chroma gain supply voltage characteristics

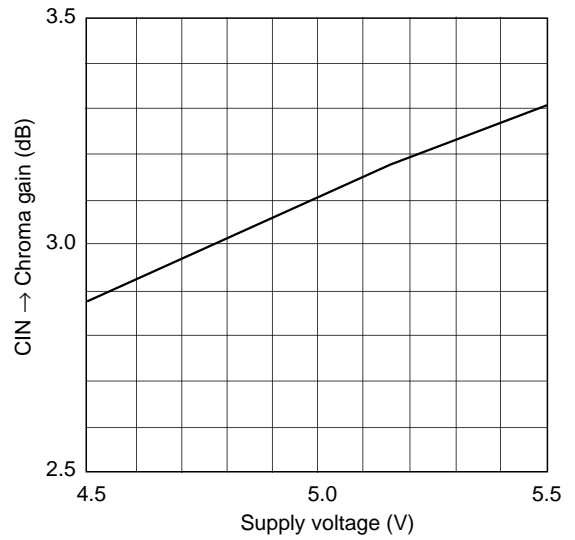

CXA1390 Series System Diagram

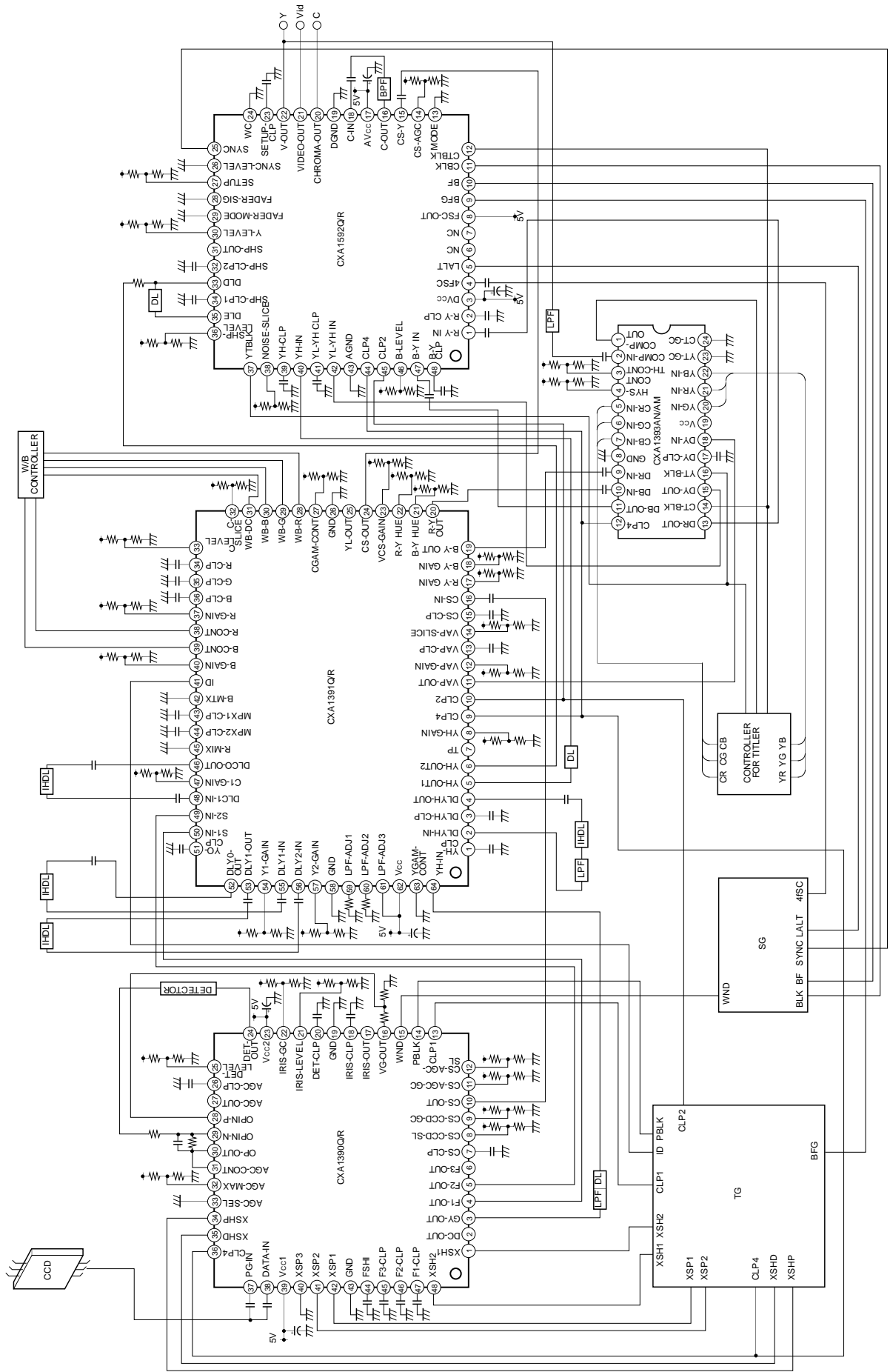

Package Outline

Unit: mm

CXA1592Q

48PIN QFP (PLASTIC)

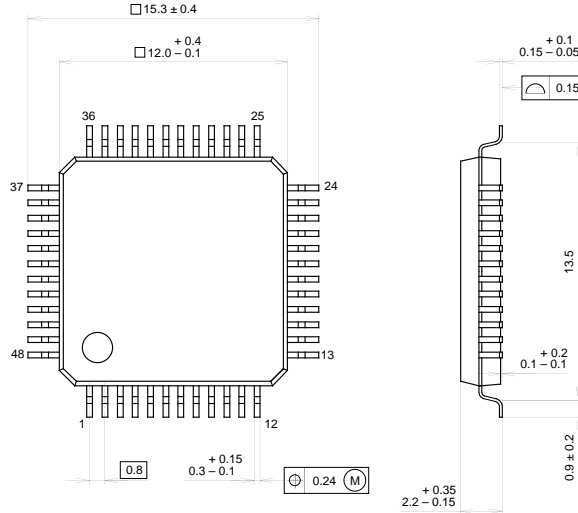

SONY CODE	QFP-48P-L04
EIAJ CODE	QFP048-P-1212
JEDEC CODE	

PACKAGE STRUCTURE

PACKAGE MATERIAL	EPOXY RESIN
LEAD TREATMENT	SOLDER / PALLADIUM PLATING
LEAD MATERIAL	42/COPPER ALLOY
PACKAGE MASS	0.7g

NOTE : PALLADIUM PLATING

This product uses S-PdPPF (Sony Spec.-Palladium Pre-Plated Lead Frame).

CXA1592R

48PIN LQFP (PLASTIC)

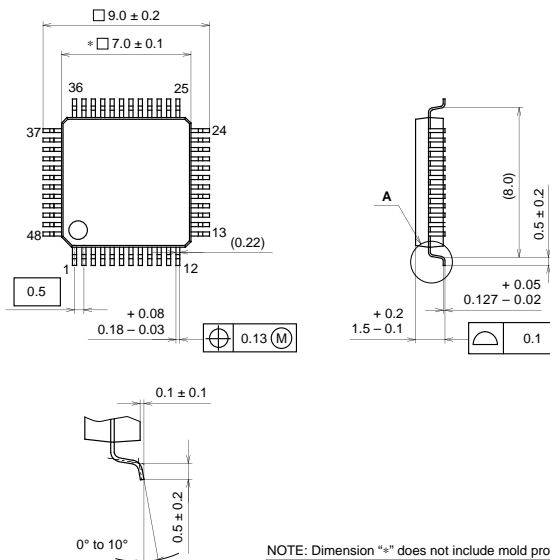

SONY CODE	LQFP-48P-L01
EIAJ CODE	LQFP048-P-0707
JEDEC CODE	

PACKAGE STRUCTURE

PACKAGE MATERIAL	EPOXY RESIN
LEAD TREATMENT	SOLDER/PALLADIUM PLATING
LEAD MATERIAL	42/COPPER ALLOY
PACKAGE MASS	0.2g