

SONY

CXA1330S CXA1331S/M CXA1332S/M

Dolby B/C Type Noise Reduction System

Description

The CXA1330 / CXA1331 / CXA1332 are bipolar ICs providing two separate Dolby B/C type noise reduction processors. The series is composed of five devices having three Dolby levels and two types of package for various applications. These devices feature very few external components, which is achieved by monolithic filter circuits using integrated thin film capacitors with high capacitance.

Features

- Minimum number of external components
- Inductorless spectral skewing circuit
- NR ON/OFF, REC/PB and MPX filter ON/OFF switches included
- Small package (30 pin Shrink-DIP, 30 pin SOP)
- Low current consumption 12.2mA typ. (CXA1331)
- Dual channel processors in one chip

Absolute Maximum Ratings

(Ta = 25°C, unless otherwise specified)

• Supply voltage	V _{cc}	17	V
• Operating temperature	T _{opr.}	- 40 to + 85	°C
• Storage temperature	T _{stg.}	- 65 to + 150	°C
• Allowable power dissipation	P _D		
	SDIP30 (A1330S/A1331S/A1332S)	1200	mW
	SOP30 (A1331M/A1332M)	600	mW

* These ICs are available only to the licensees of Dolby Laboratories Licensing Corporation from whom licensing and applications information may be obtained.

* "Dolby" and the double D symbols are trade marks of Dolby Laboratories Licensing Corporation.

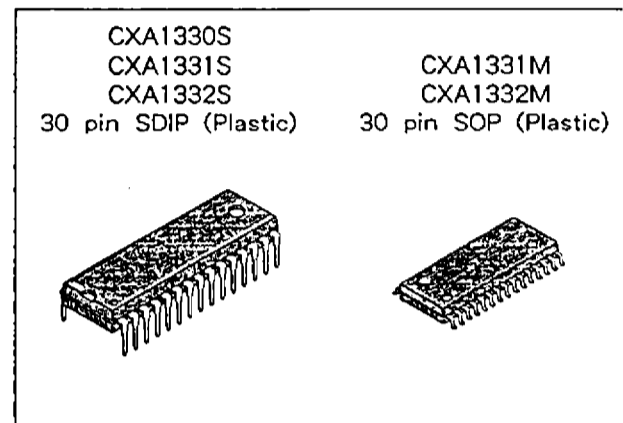

Sony reserves the right to change products and specifications without prior notice. This information does not convey any license by any implication or otherwise under any patents or other right. Application circuits shown, if any, are typical examples illustrating the operation of the devices. Sony cannot assume responsibility for any problems arising out of the use of these circuits.

Block Diagram

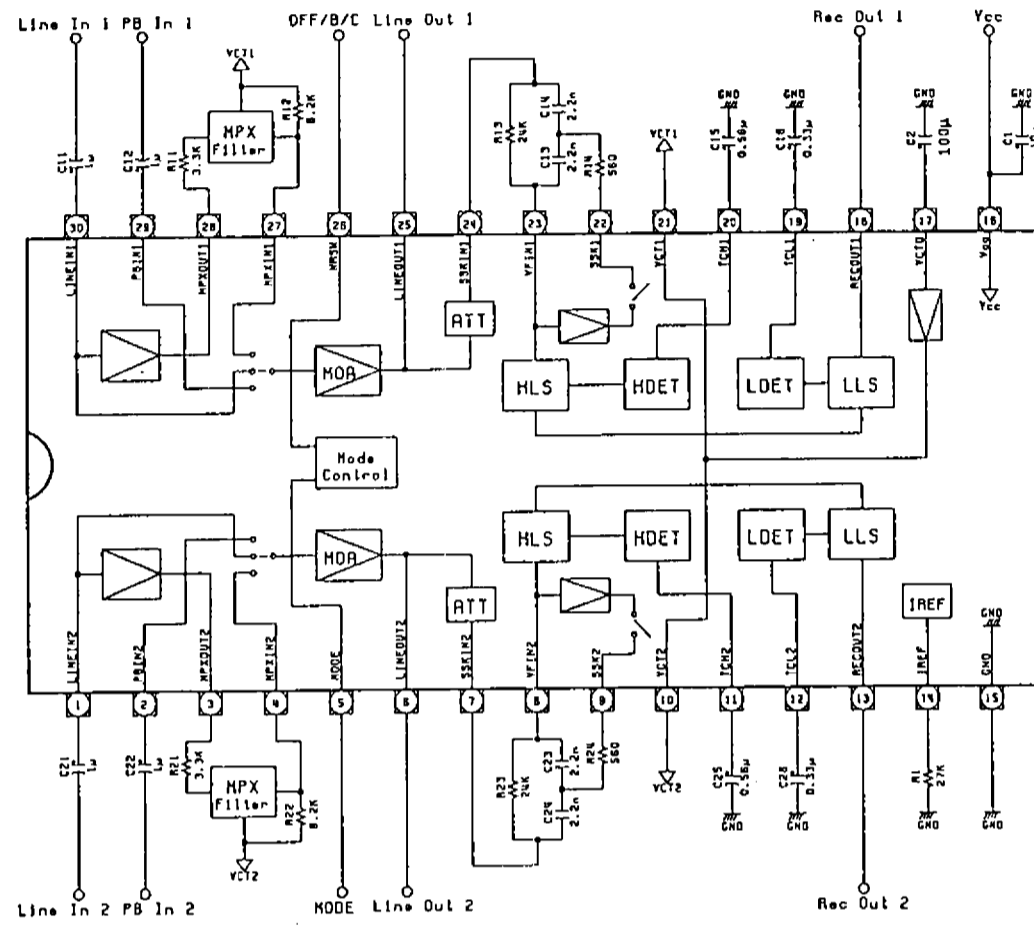

Test Circuit

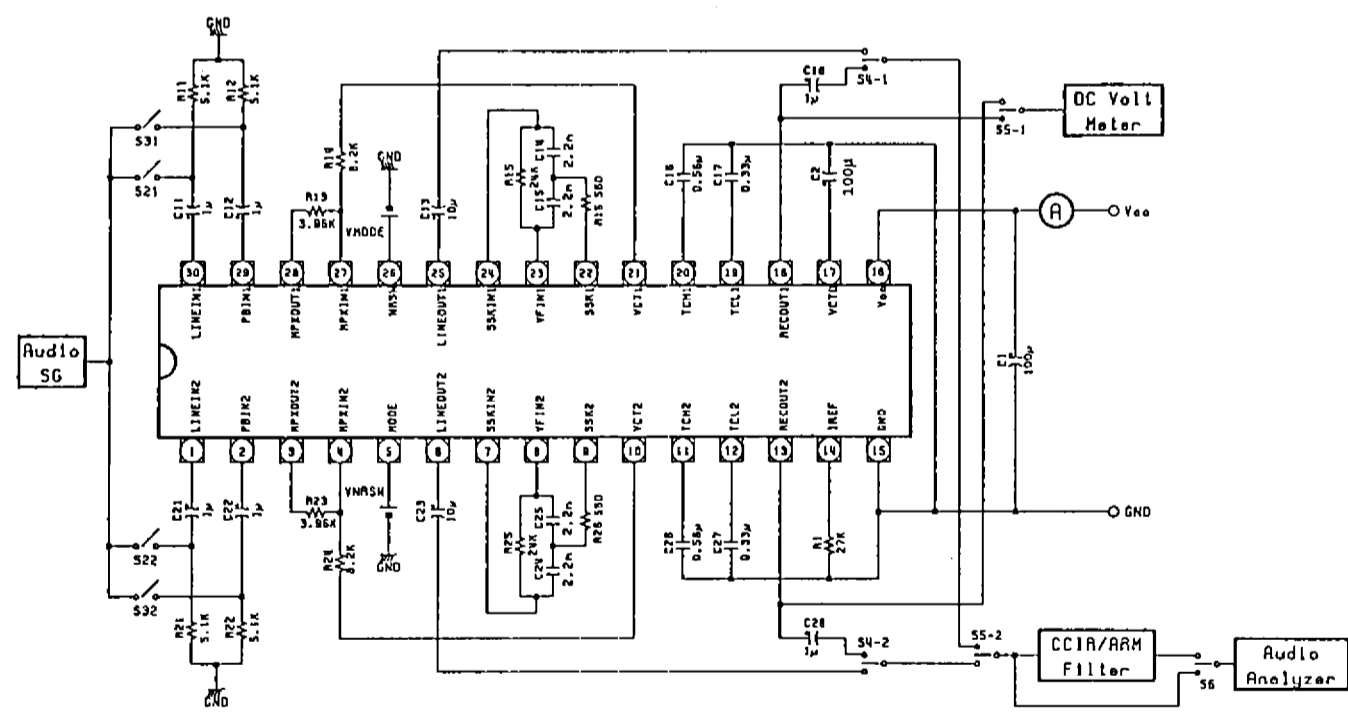

Pin Description and Equivalent Circuit

(Single Supply, No Signal)

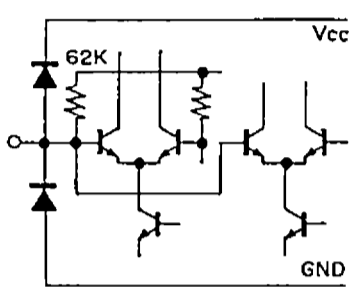
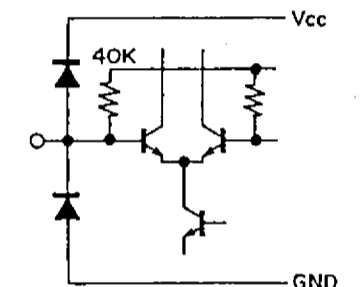
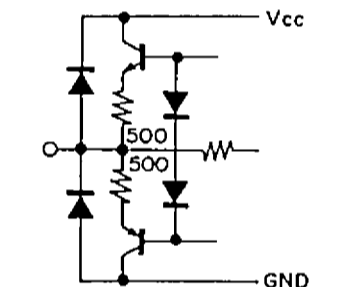
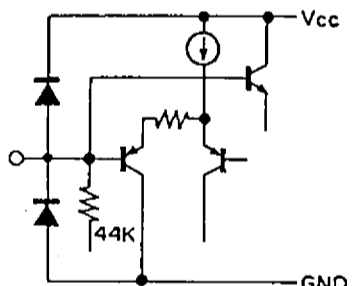
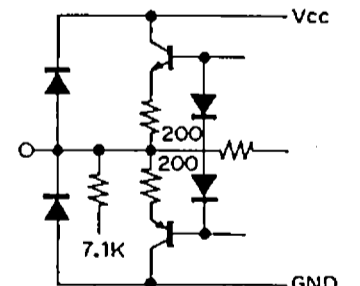
Pin No.	Symbol	Z : Imp. VDC (V)	Equivalent circuit	Description
1, 30	LINE IN	62K $V_{cc}/2$		Line (Record) input pin Ref. Level = - 25dBm
2, 29 4, 27	PB IN MPX IN	40K $V_{cc}/2$		Playback input pin Ref. Level = - 30dBm
3, 28	MPX OUT	≈ 0 $V_{cc}/2$		Buffer amplifier output pin to drive multiplex filter Ref. Level = - 21dBm
5 26	MODE NRSW	44K —		Mode control (Pin 5) H : REC (Filter on) M : REC (Filter off) L : PB NR control (Pin 26) H : C-type M : B-type L : NR off
6, 25	LINE OUT	≈ 0 $V_{cc}/2$		Line output pin

Pin No.	Symbol	Z : Imp. VDC (V)	Equivalent circuit	Description
7, 24	SSK IN	1.78K $V_{cc}/2$		Output pin to drive spectral skewing circuit Ref. Level = -6dBm
8, 23	VF IN	$\approx \infty$ $V_{cc}/2$		Input pin of encoder Ref. Level = -6dBm
9, 22	SSK	$V_{cc}/2$		Switching output pin for spectral skew on/off
10, 21	VCT	≈ 0 $V_{cc}/2$		$V_{cc}/2$ output pin (Connected in IC)
11, 20	TCH	0.4V		Time constant connecting pin for HLS detector

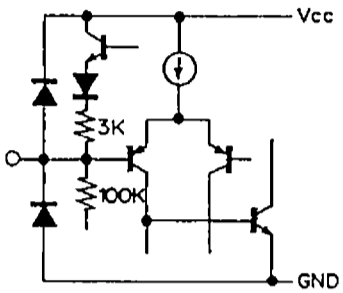
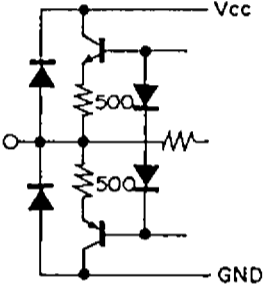
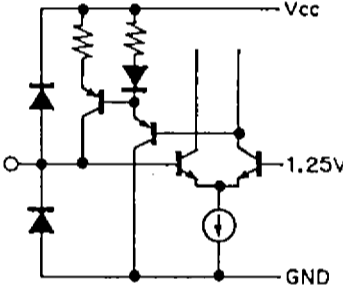
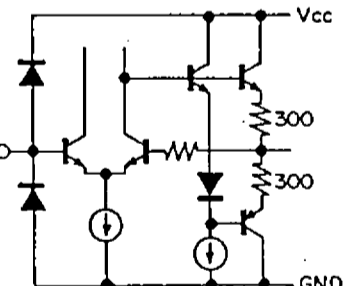
Pin No.	Symbol	Z : Imp. VDC (V)	Equivalent circuit	Description
12, 19	TCL	— 0.4V		Time constant connecting pin for LLS detector
13, 18	REC OUT	≈0 Vcc/2		Record output pin Ref. Level = - 6dBm
14	IREF	≈0 1.25V		Reference current pin to define cut-off frequency of integrated filters
15	GND	0		Single power supply : GND pin Split power supply : VEE
16	Vcc	Vcc		Vcc power supply pin
17	VCT0	12K Vcc/2		Reference voltage pin Single power supply : connect decouple capacitor Split power supply : connect to GND

Electrical Characteristics

Ta = 25°C, Dolby Level : -6dBm (= 388mVrms) at REC OUT

Vcc = 15V (for CXA1330), Vcc = 12V (for CXA1331), Vcc = 9V (for CXA1332) unless otherwise specified.

Characteristics	Symbol	Test Conditions * 1				Min.	Typ.	Max.	Unit
		R/P	NR	f (Hz)	Other Conditions				
Operating Voltage CXA1330 CXA1331 CXA1332	Vopr	—	—	—		11.5 8.5 7.0	— — —	16.0 16.0 16.0	V V V
Current consumption CXA1330 CXA1331 CXA1332	Icc	REC	OFF	—	No Signal	8.0 8.0 8.0	12.5 12.2 12.0	18.0 18.0 18.0	mA mA mA
LINE OUT Level CXA1330 CXA1331 CXA1332	Vlout	REC	OFF	1k		-1.0 -4.0 -7.0	0.0 -3.0 -6.0	1.0 -2.0 -5.0	dBm dBm dBm
LINE IN Level	Vlin	REC	OFF	1k		-27	-25	-23	dBm
PB IN Level	Vpin	PB	OFF	1k		-32	-30	-28	dBm
MPX Amp Gain	Gmpx	MPX	OFF	1k		3.0	4.0	5.0	dB
Encode Characteristics									
B type Boost									
(1)	B-R-1	REC	B	500	-25dB	1.4	2.9	4.4	dB
(2)	B-R-2	REC	B	5k	-25dB	3.9	5.4	6.9	dB
(3)	B-R-3	REC	B	10k	-40dB	9.7	10.4	11.4	dB
(4)	B-R-4	REC	B	10k	0dB	-1.1	0.4	1.9	dB
C type Boost									
(1)	C-R-1	REC	C	500	-60dB	14.2	16.2	18.2	dB
(2)	C-R-2	REC	C	500	-25dB	7.2	9.2	11.2	dB
(3)	C-R-3	REC	C	2k	-60dB	18.7	20.7	22.7	dB
(4)	C-R-4	REC	C	2k	-25dB	5.4	7.4	9.4	dB
(5)	C-R-5	REC	C	5k	-25dB	3.5	5.5	7.5	dB
(6)	C-R-6	REC	C	10k	0dB	-5.5	-3.5	-1.5	dB

Characteristics	Symbol	Test Conditions * 1				Min.	Typ.	Max.	Unit
		R/P	NR	f (Hz)	Other Conditions				
Signal Handling CXA1330 CXA1331 CXA1332	Vomax	REC	OFF	1k	THD = 1 %	13.5 13.5 13.5	15.8 16.2 16.0	— — —	dB dB dB
Total Harmonic Distortion									
1) NR OFF CXA1330 CXA1331 CXA1332	THD (OFF)	REC	OFF	1k	+ 10dB	— — —	0.04 0.07 0.09	0.15 0.15 0.15	% % %
2) B type CXA1330 CXA1331 CXA1332	THD (B)	REC	B	1k	+ 10dB	— — —	0.06 0.09 0.12	0.2 0.2 0.2	% % %
3) C type CXA1330 CXA1331 CXA1332	THD (C)	REC	C	1k	+ 10dB	— — —	0.05 0.08 0.12	0.3 0.3 0.3	% % %
Encode S/N Ratio	SN (CCIR)	REC	C	—	Rg = 5kΩ (CCIR/ARM)	60	64	—	dB
Crosstalk REC-PB PB-REC REC ch to ch	CT-1 CT-2 CT-3	PB REC REC	OFF OFF OFF	1k 1k 1k	0dB 0dB 0dB	— — —	- 80 - 87 - 73	- 70 - 70 - 65	dB dB dB
REC OUT Offset Voltage (OFF-C type)	Voff	REC	OFF→C	—		- 100	0	100	mV

* 0dB means the level which provides the Dolby level at the record output in the noise reduction off mode.

Quiescent current consumption vs. Supply voltage

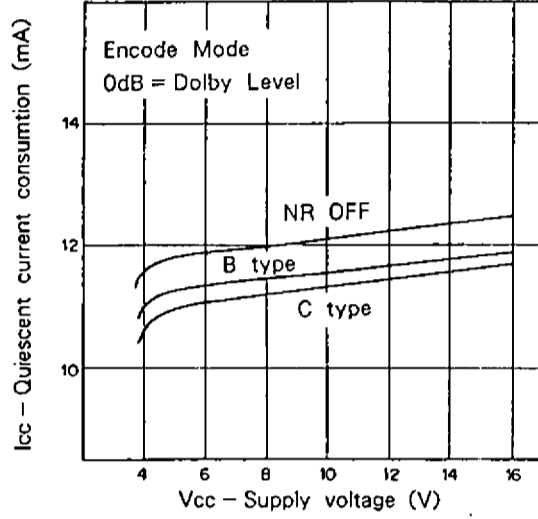

Current consumption vs. Input level (CXA1331)

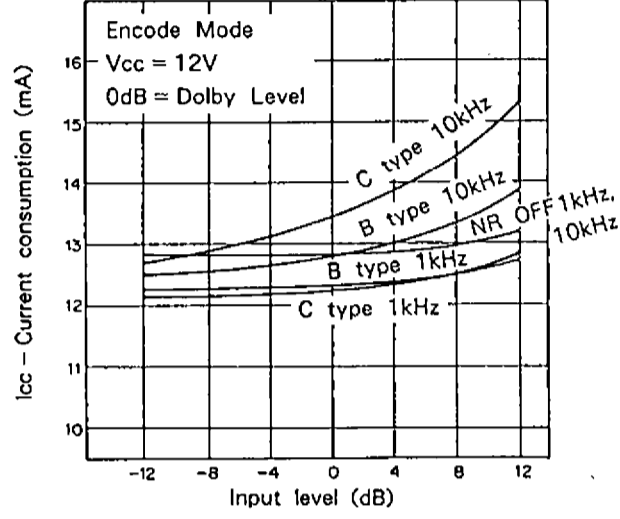

B type encode characteristics

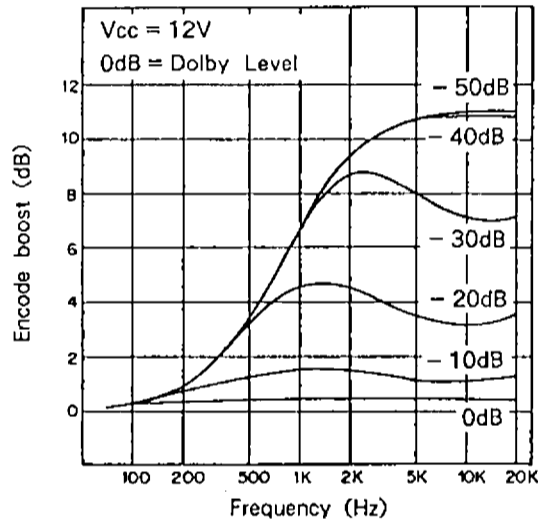

C type encode characteristics

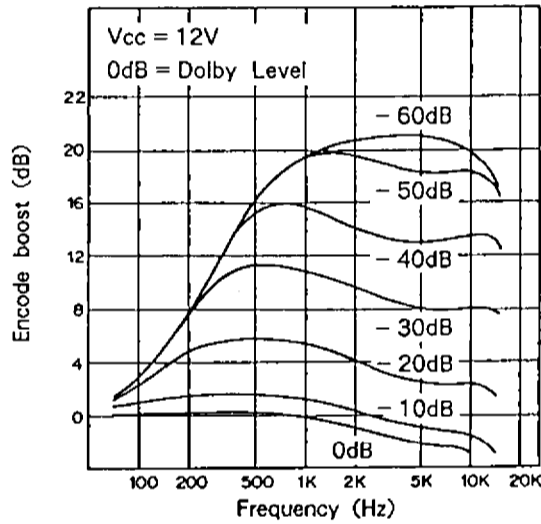

Signal handling

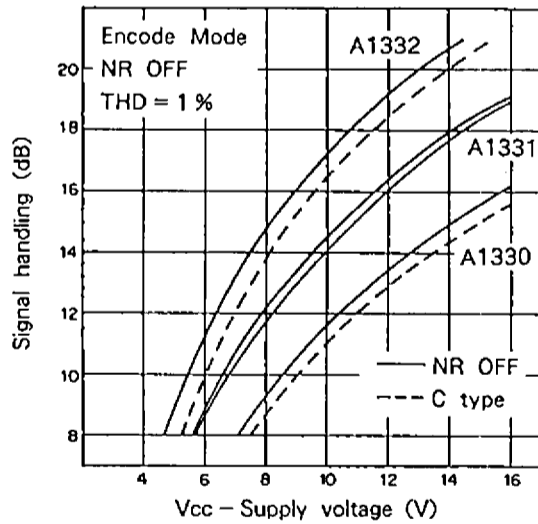

Load characteristics (CXA1331)

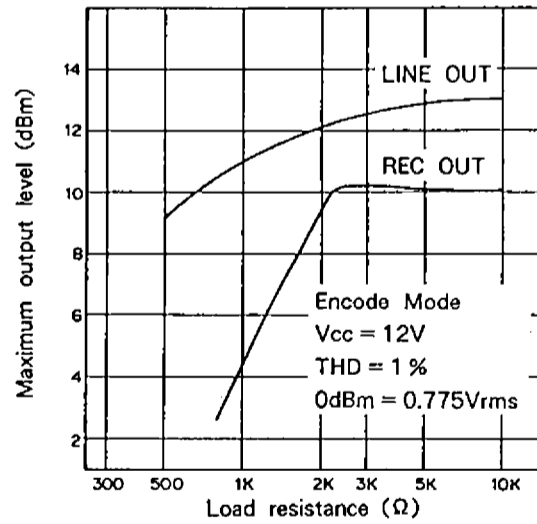

NR OFF total harmonic distortion-1 (CXA1331)

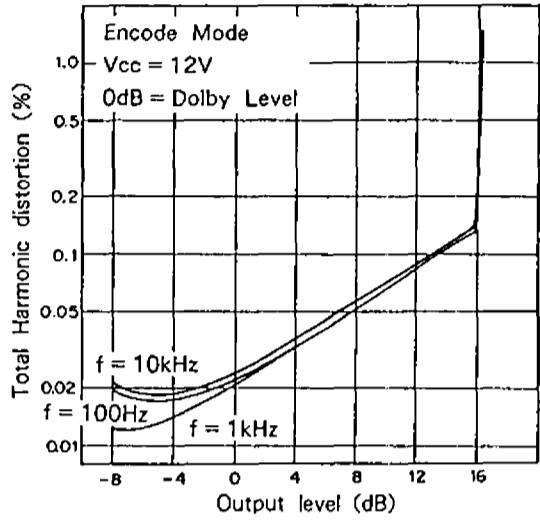

B type total harmonic distortion-1 (CXA1331)

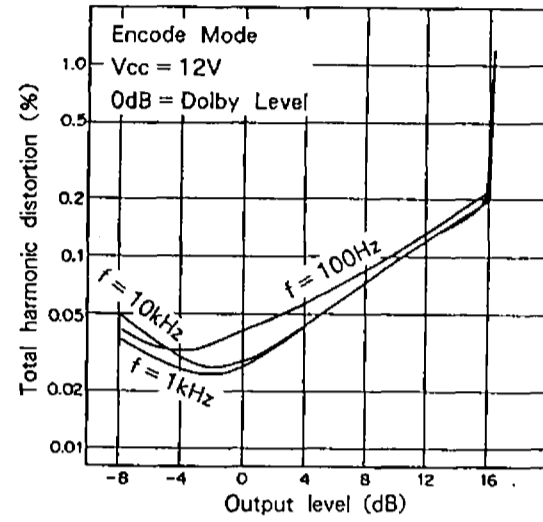

C type total harmonic distortion-1 (CXA1331)

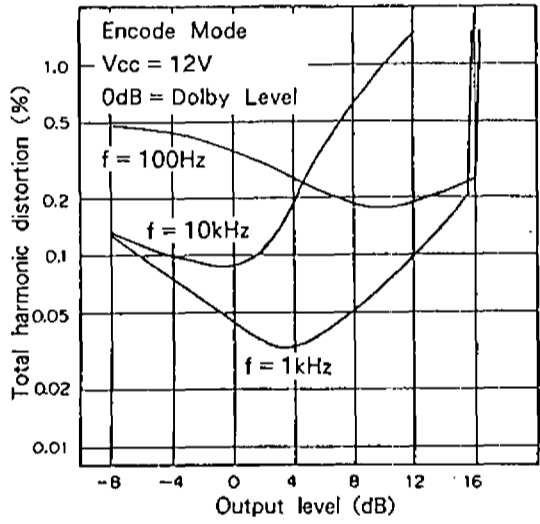

NR OFF total harmonic distortion-2 (CXA1330)

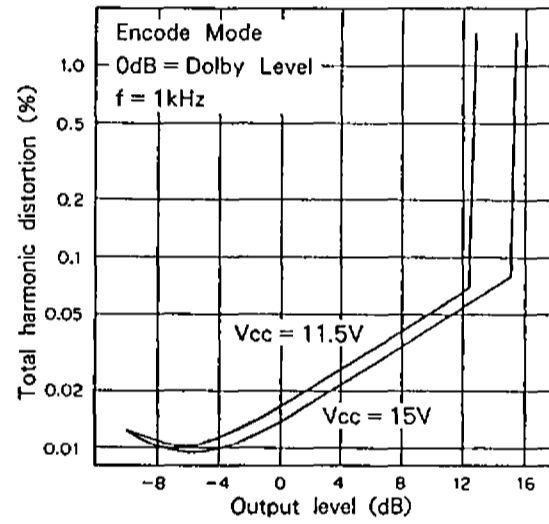

B type total harmonic distortion-2 (CXA1330)

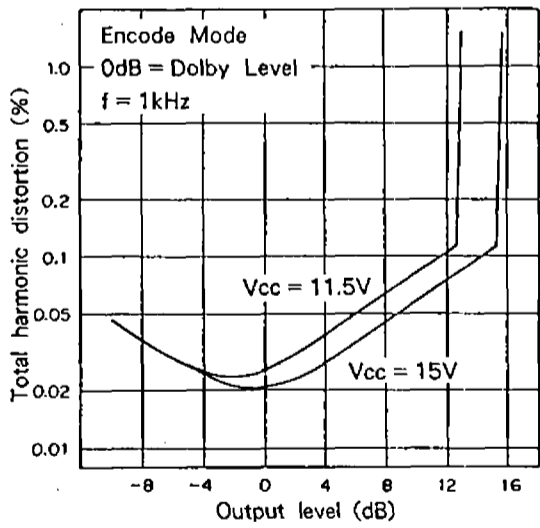

C type total harmonic distortion-2 (CXA1330)

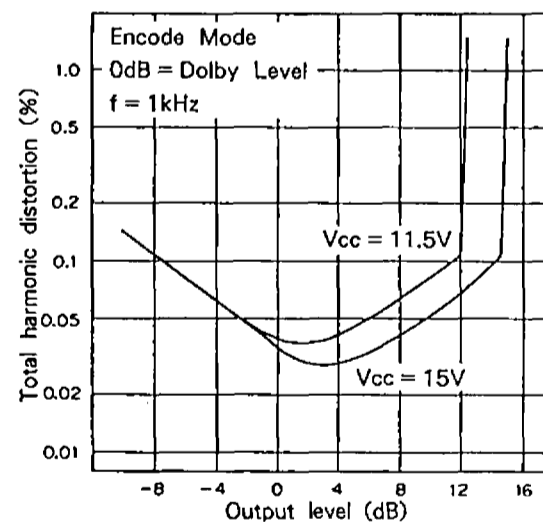

NR total harmonic distortion-3 (CXA1331)

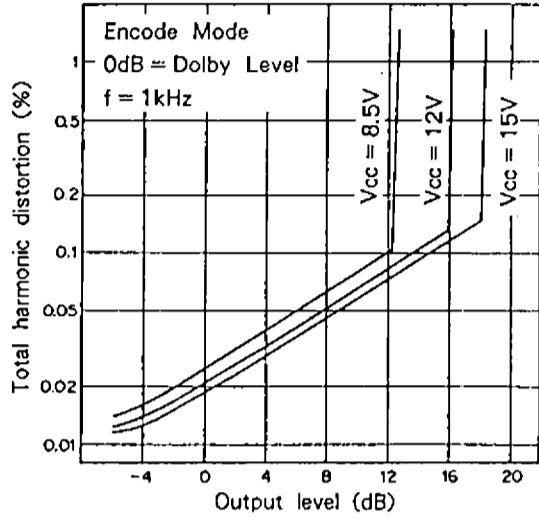

B type total harmonic distortion-3 (CXA1331)

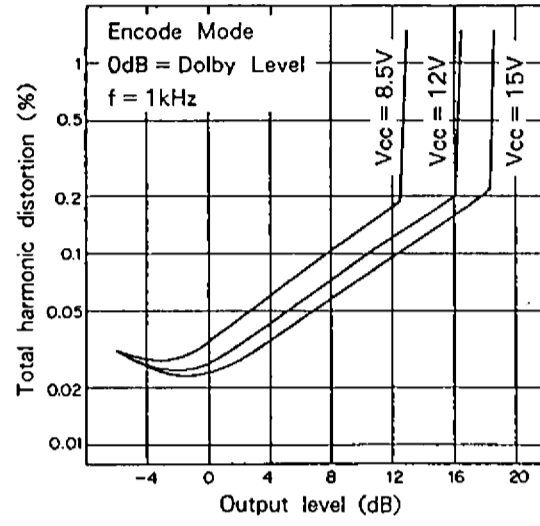

C type total harmonic distortion-3 (CXA1331)

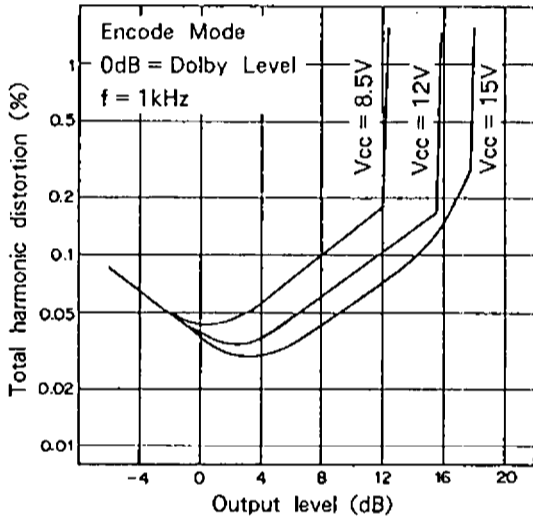

NR OFF total harmonic distortion-4 (CXA1332)

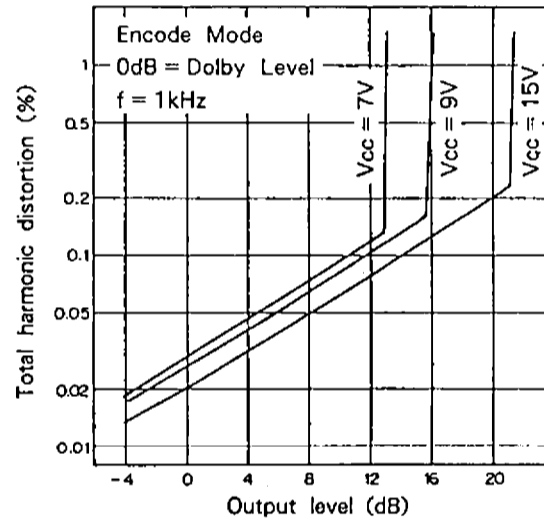

B type total harmonic distortion-4 (CXA1332)

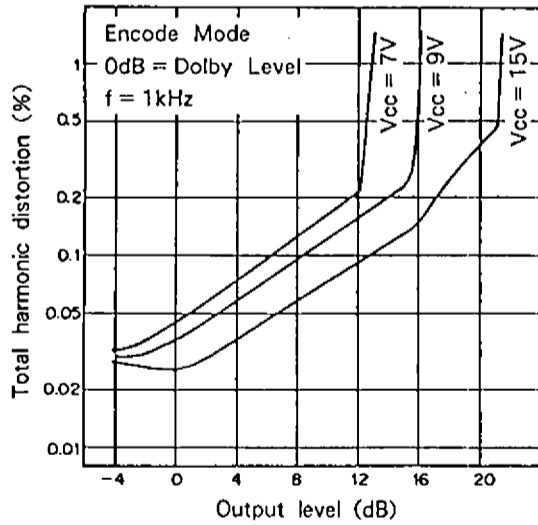

C type total harmonic distortion-4 (CXA1332)

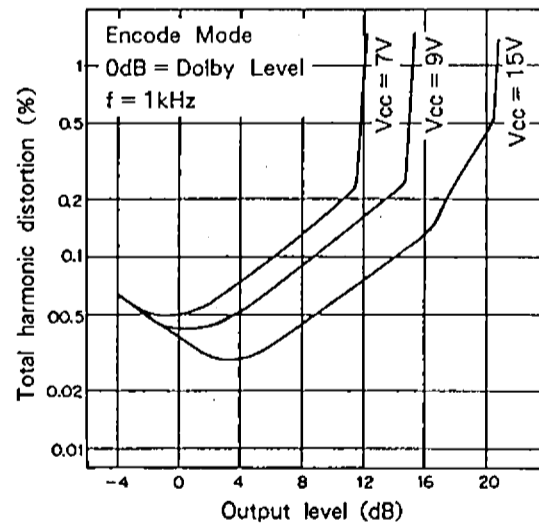

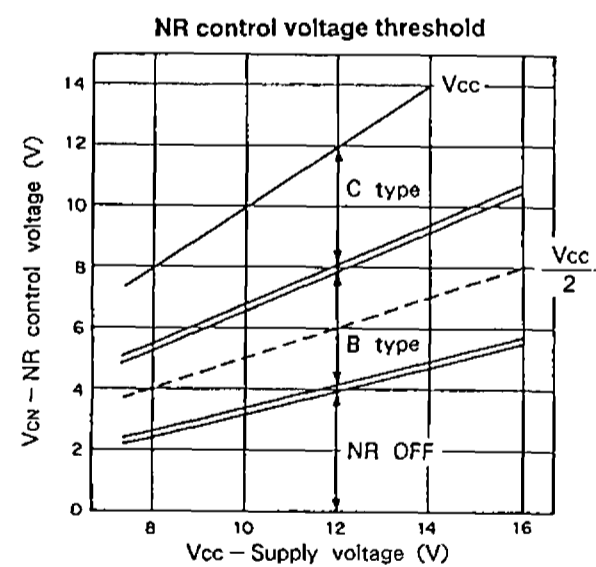
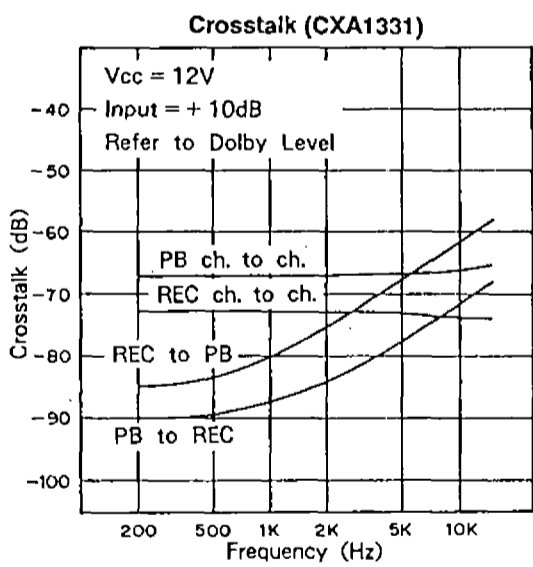
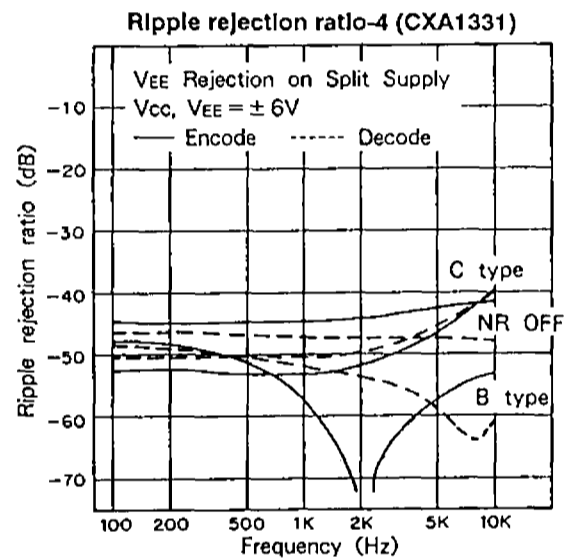
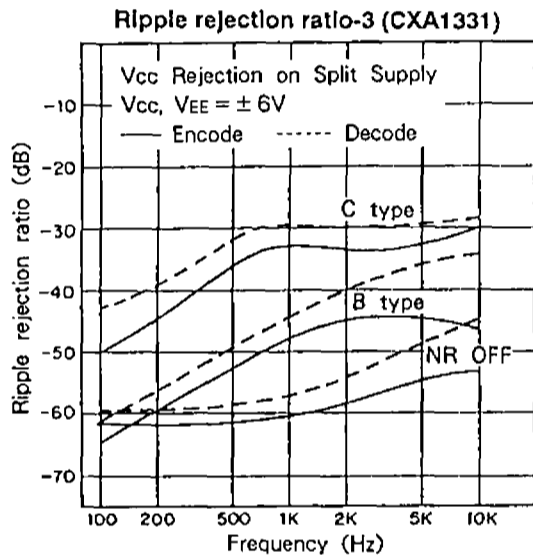
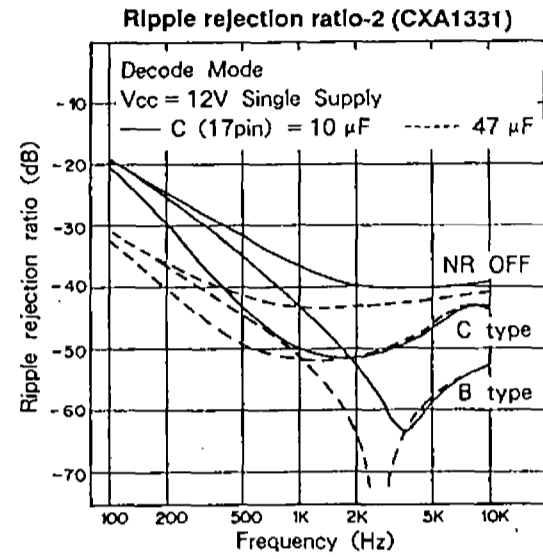
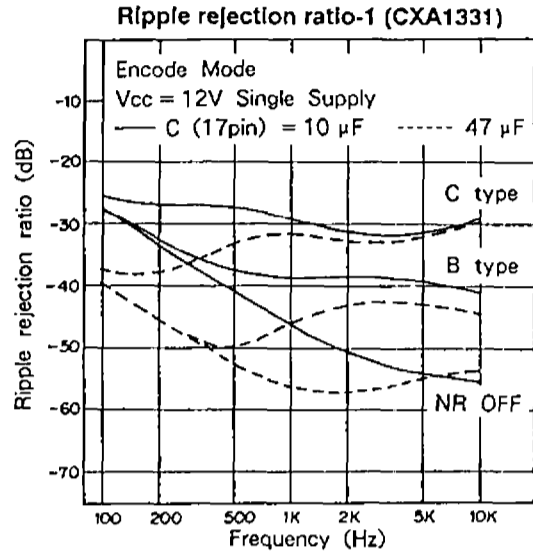

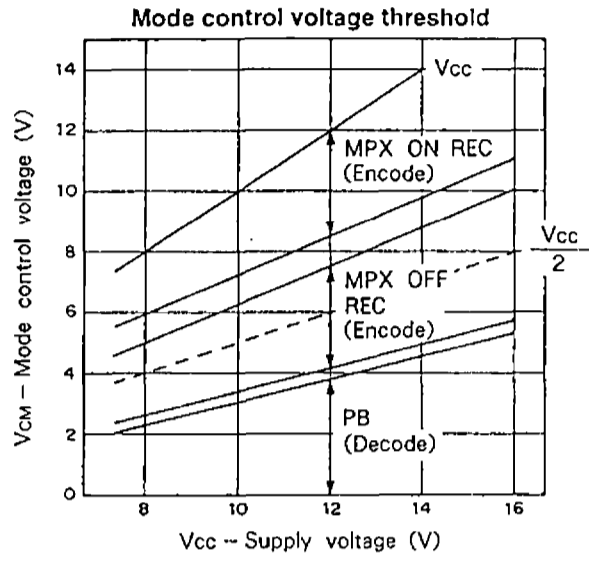

Notes on Application

The CXA1330 series is a dual channel Dolby B/C type noise reduction IC using monolithic filter circuits in the same way as the CXA1100 series B type IC. The series provides three different line output levels to apply to various applications, and the levels of the CXA1330/A1331/A1332 are identical with those of the CXA1100/A1101/A1102 respectively. The record output level is increased to -6dBm to improve noise performance.

1) Power Supply

The CXA1330 series is designed to operate on either single or split power supply. The ripple rejection performance is excellent for either supply. VCT1(Pin 21) and VCT2(Pin 10) are outputs of the $V_{cc}/2$ buffer amplifier and are connected together internally. VCT0(Pin 17) is a reference voltage of the $V_{cc}/2$ buffer amplifier. With single power supply operation, internally generated $V_{cc}/2$ voltage appears at the pin, and a bypass capacitor has to be connected between the pin and ground. On split power supply operation, the VCT0(Pin 17) pin has to be connected to ground, and V_{EE} (negative power supply) is supplied to the GND(Pin 15) pin.

The operation voltage ranges are

CXA1330	11.5 to 16V (± 6.75 to $\pm 8V$)
CXA1331	8.5 to 16V (± 4.25 to $\pm 8V$)
CXA1332	7.0 to 16V (± 3.5 to $\pm 8V$)

The devices will satisfy the signal handling of 12dB using the above power supply ranges.

2) Operation Mode Control

The CXA1330 series provides fully electronic switching circuits. The functions are controlled by DC voltages as the two control pins of MODE(Pin 5) and NRSW(Pin 26). The switching truth tables are shown in Fig.a-1. VH, VM and VL are V_{cc} , $V_{cc}/2$ and GND respectively for single power supply, and are V_{cc} , GND and V_{EE} respectively for split power supply. Regard thresholds of the control voltages, see graph of "Mode Control Voltage Threshold" and "NR Control Voltage Threshold". Control pins of MODE(Pin 5) and NRSW(Pin 26) are connected to VCT1/2(Pin 10/21) via 44k Ω resistor, therefor opening the pin gives the condition of VM.

Fig. a-1

MODE	VH	VM	VL	NRSW	VH	VM	VL
Function	MPX ON REC (Encode)	MPX OFF REC (Encode)	PB (Decode)	Function	C type	B type	NR off

3) Reference Level

The Dolby level of the CXA1330 series is -6dBm (388mVrms), and is measured at the record output (RECOU Pin 13/18) in the NR off mode. The reference levels of the record input (RECIN), playback input (PBIN) and line out (LINE OUT) are defined as the levels which provide Dolby level at the record output in the NR off mode.

The series is composed of three kinds of chips with different line output levels for various applications. Other reference levels, the record input level, playback input level and record output level (= Dolby level) are identical in all devices.

The reference levels are as follows

Record output level (= Dolby level)		-6dBm	(388mVrms)
Record input level		-25dBm	(43.6mVrms)
Playback input level		-30dBm	(24.5mVrms)
Line output level	CXA1330	0dBm	(775mVrms)
	CXA1331	-3dBm	(548mVrms)
	CXA1332	-6dBm	(388mVrms)

4) MPX Filter

The CXA1330 series provides a MPX (FM multiplex) filter on/off function. The MPX filter is connected between MPXOUT (Pin 3/28) and MPXIN (Pin 4/27). In the MPX on mode the line input signal is fed to the noise reduction processor via MPX buffer amplifier and the MPX filter. In MPX off mode the signal is directly fed to the noise reduction processor bypassing the buffer amplifier and the filter. The gain of the MPX buffer amplifier is 4dB , which means that the insertion loss of the filter should be 4dB . The deviation of the insertion loss from 4dB causes gain shift between MPX on and off.

5) Application for dubbing cassette decks

The CXA1330 series generates non decoded signal at the record output in the decode mode. For more the details, see Sony Dolby B/C type IC (CX20187/CXA1097Q or CX20188/CXA1098Q) data sheet.

Switchable Processor with Single Power Supply

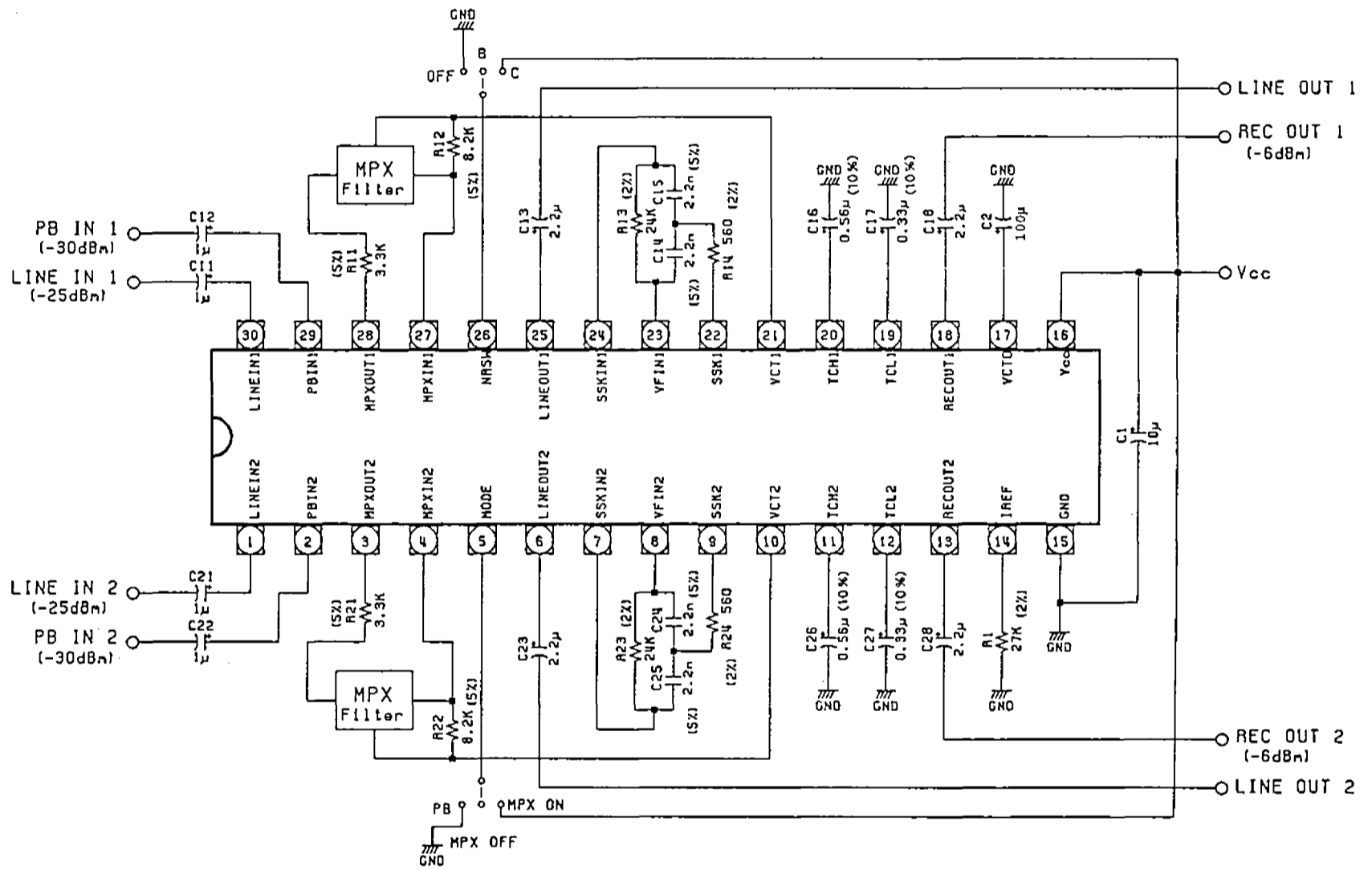

Note) Resistor and capacitor tolerances are $\pm 10\%$ and $\pm 20\%$ respectively unless otherwise specified.

Switchable Processor with Power Supply

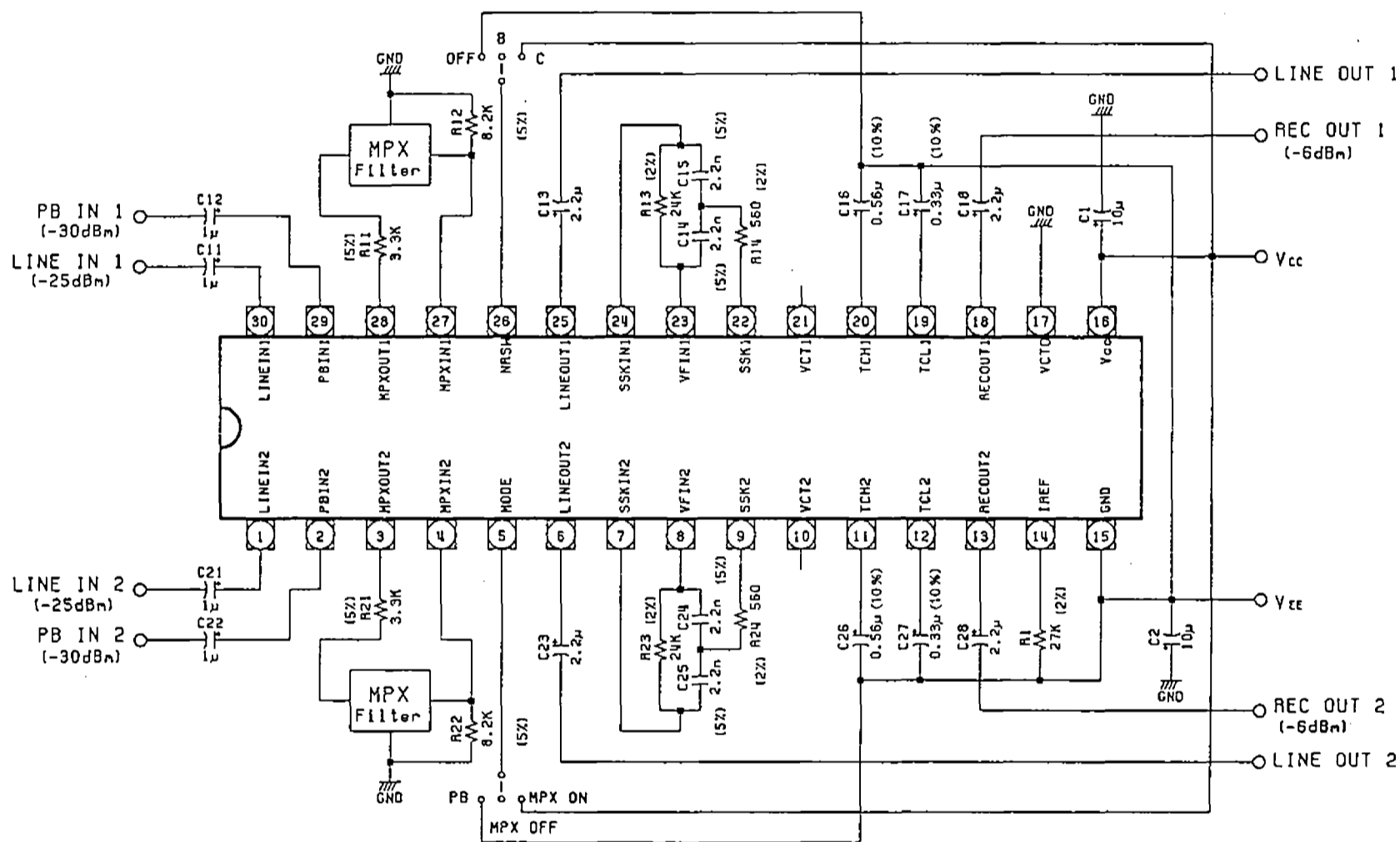

Note) Resistor and capacitor tolerances are $\pm 10\%$ and $\pm 20\%$ respectively unless otherwise specified.

Playback Processor with AUX Input

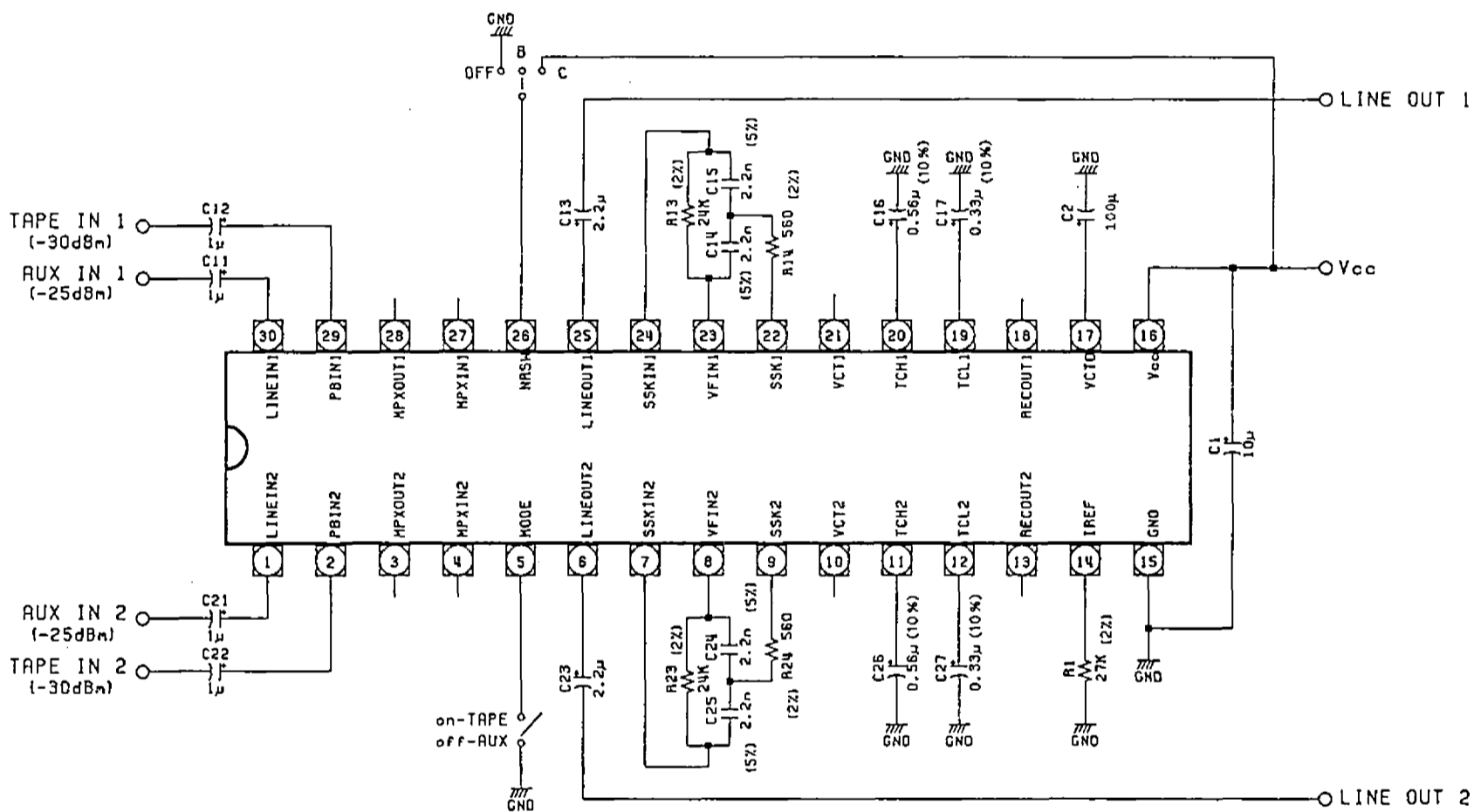

Note) Resistor and capacitor tolerances are $\pm 10\%$ and $\pm 20\%$ respectively unless otherwise specified.

Package Outline Unit : mm

CXA1330S 30 pin SDIP (Plastic) 400mil 1.8g
 CXA1331S
 CXA1332S

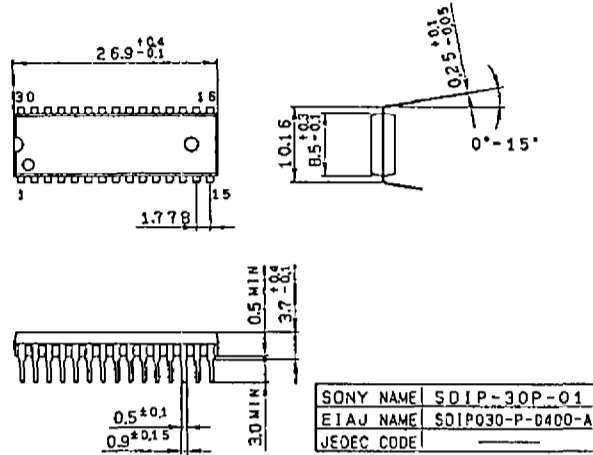

CXA1331M 30 pin SOP (Plastic) 375mil 0.7g
 CXA1332M

