

CLC5956

12-Bit, 65 MSPS Broadband Monolithic A/D Converter

General Description

The CLC5956 is a monolithic 12-bit, 65 MSPS analog-to-digital converter subsystem. The device has been optimized for use in cellular base stations and other applications where high resolution, high sampling rate, wide dynamic range, low power dissipation, and compact size are required. The CLC5956 features differential analog inputs, low jitter differential PECL clock inputs, a low distortion track-and-hold with DC to 300 MHz input bandwidth, a band-gap voltage reference, TTL compatible CMOS output logic, and a proprietary 12-bit multi-stage quantizer. The CLC5956 is fabricated on the ABIC-IV 0.8 micron BiCMOS process. The part features a 73 dB spurious free dynamic range (SFDR) and 67 dB SNR. The wideband track-and-hold allows sampling of IF signals to greater than 250 MHz. The part produces two-tone, dithered, spurious-free dynamic range of 83 dBFS at 75 MHz input frequency. The differential analog input provides excellent common-mode rejection, while the differential PECL clock inputs permit the use of balanced transmission to minimize jitter in distributed systems. The 48-pin TSSOP package provides an extremely small footprint for applications where space is a critical consideration. The CLC5956 operates from a single +5V power supply over the industrial temperature range of -40°C to $+85^{\circ}\text{C}$. National thoroughly tests each part to verify full compliance with the guaranteed specifications.

Features

- Wide dynamic range
- IF sampling capability
- 300 MHz input bandwidth
- Small 48-pin TSSOP
- Single +5V supply
- Low cost

Key Specifications

- Sample Rate
- SFDR
- SFDR with dither
- SNR
- Low power consumption

65 MSPS
73 dBc
85 dBFS
67 dB
615 mW

Applications

- Cellular base-stations
- Digital communications
- Infrared/CCD imaging
- IF sampling
- Electro-optics
- Instrumentation
- Medical imaging
- High definition video

Block Diagram

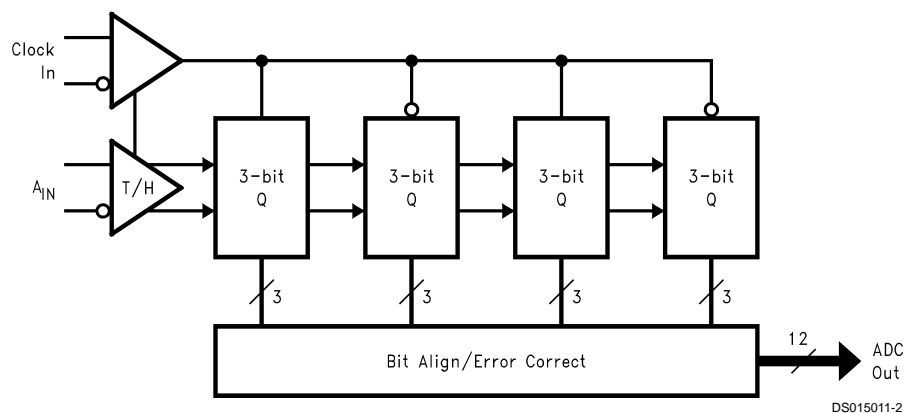

Pin Configuration

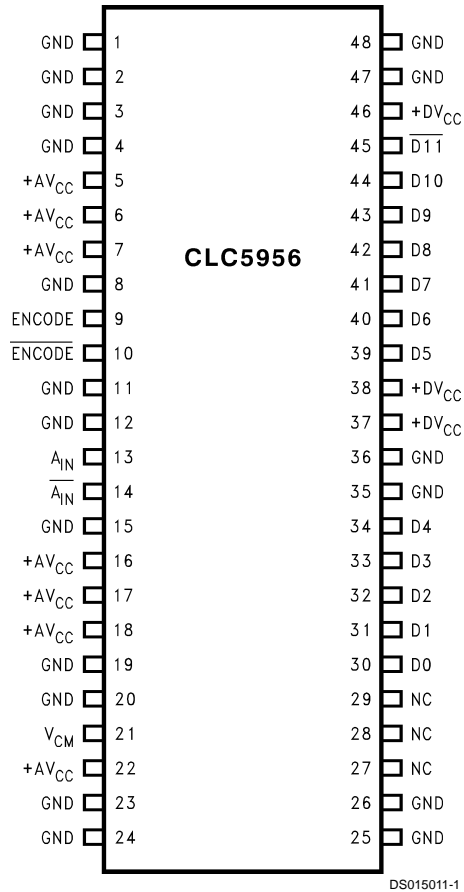

Ordering Information

CLC5956IMTD	48-Pin TSSOP
CLC5956IMTDX	48-Pin TSSOP (Taped Reel)
CLC5956PCASM	Evaluation Board

Pin Descriptions

Pin Name	Pin No.	Description
$\frac{A_{IN}}{A_{IN}}$	13, 14	Differential input with a common mode voltage of +2.4V. The ADC full scale input is 1.024 V_{PP} on each of the complimentary input signals.
$\frac{ENCODE}{ENCODE}$	9, 10	Differential clock where ENCODE initiates a new data conversion cycle on each rising edge. Logic for these inputs are a 50% duty cycle differential PECL signal.
V_{CM}	21	Internal common mode voltage reference. Nominally +2.4V. Can be used for the input common mode voltage. This voltage is derived from an internal bandgap reference. V_{CM} should be buffered when driving any additional load beyond the input transformer. Failure to buffer this signal can cause errors in the internal bias currents.
$D0-\overline{D11}$	30–34, 39–45	Digital data outputs are CMOS and TTL compatible. D0 is the LSB and $\overline{D11}$ is the MSB. MSB is inverted. Output coding is two's complement.
GND	1–4, 8, 11, 12, 15, 19, 20, 23–26, 35, 36, 47, 48	Circuit ground.
+AV _{CC}	5–7, 16–18, 22	+5V power supply for the analog section. Bypass to ground with a 0.1 μ F capacitor.
+DV _{CC}	37, 38, 46	+5V power supply for the digital section. Bypass to ground with a 0.1 μ F capacitor.
NC	27, 28, 29	No connect. May be left open or grounded.

Absolute Maximum Ratings (Note 1)

If Military/Aerospace specified devices are required, please contact the National Semiconductor Sales Office/Distributors for availability and specifications.

Positive Supply Voltage (V_{CC})	-0.5V to +6V
Differential Voltage between any Two Grounds	<200 mV
Analog Input Voltage Range	GND to V_{CC}
Digital Input Voltage Range	-0.5V to + V_{CC}
Output Short Circuit Duration (one-pin to ground)	Infinite
Junction Temperature (Note 7)	175°C
Storage Temperature Range	-65°C to +150°C
Lead Solder Duration (+300°C)	10 sec.
ESD tolerance	
human body model	2000V
machine model	200V

Recommended Operating Conditions

Positive Supply Voltage (V_{CC})	+5V ±5%
Analog Input Voltage Range	2.048 V_{PP} diff.
Operating Temperature Range	-40°C to +85°C

Package Thermal Resistance (Note 7)

Package	θ_{JA}	θ_{JC}
48-Pin TSSOP	56°C/W	16°C/W

Reliability Information

Transistor Count	5000
------------------	------

Converter Electrical Characteristics

The following specifications apply for $AV_{CC} = DV_{CC} = +5V$, 52 MSPS, 50% Encode Clock Duty Cycle. **Boldface limits apply for $T_A = T_{min} = -40^\circ C$ to $T_{max} = +85^\circ C$** , all other limits $T_A = 25^\circ C$ (Note 4).

Symbol	Parameter	Conditions	Min	Typ	Max	Units
DYNAMIC PERFORMANCE						
BW	Large-Signal Bandwidth	$V_{IN} = FS -3 dB$		300		MHz
	Overvoltage Recovery Time	$V_{IN} = 1.5 FS (0.01\%)$		12		ns
t_{DS}	Effective Aperture Delay			-0.21		ns
t_{AJ}	Aperture Jitter			0.4		ps(rms)
NOISE AND DISTORTION						
SNR	Signal-to-Noise Ratio (without harmonics)	$f_{IN} = 20 MHz, FS -1 dB$ (Note 2)	63	66		dBFS
		$f_{IN} = 5 MHz, FS -3 dB$		67		dBFS
		$f_{IN} = 25 MHz, FS -3 dB$		66		dBFS
		$f_{IN} = 75 MHz, FS -3 dB$		64		dBFS
		$f_{IN} = 150 MHz, FS -3 dB$		62		dBFS
		$f_{IN} = 250 MHz, FS -3 dB$		59		dBFS
SFDR	Spurious-Free Dynamic Range	$f_{IN} = 20 MHz, FS -1 dB$ (Note 2)	66	70		dBc
		$f_{IN} = 5 MHz, FS -3 dB$		73		dBc
		$f_{IN} = 25 MHz, FS -3 dB$		70		dBc
		$f_{IN} = 75 MHz, FS -3 dB$		68		dBc
		$f_{IN} = 150 MHz, FS -3 dB$		58		dBc
		$f_{IN} = 250 MHz, FS -3 dB$		55		dBc
	Spurious-Free Dynamic Range (dithered)	$f_{IN} = 19 MHz, FS -6 dB$		85		dBFS
IMD	Intermodulation Distortion	$f_1 = 149.84 MHz, f_2 = 149.7 MHz, FS -10 dB$		68		dBFS
		$f_1 = 249.86 MHz, f_2 = 249.69 MHz, FS -10 dB$		58		dBFS
	Intermodulation Distortion (dithered)	$f_1 = 74 MHz, f_2 = 75 MHz, FS -12 dB$		83		dBFS
DC ACCURACY AND PERFORMANCE						
DNL	Differential Non-Linearity	DC; Full Scale		0.65		LSB
INL	Integral Non-Linearity	DC; Full Scale		1.7		LSB
	Bipolar Offset Error			-1		mV
	Bipolar Gain Error			-0.1		% FS

Converter Electrical Characteristics (Continued)

The following specifications apply for $V_{CC} = DV_{CC} = +5V$, 52 MSPS, 50% Encode Clock Duty Cycle. **Boldface limits apply for $T_A = T_{min} = -40^{\circ}C$ to $T_{max} = +85^{\circ}C$** , all other limits $T_A = 25^{\circ}C$ (Note 4).

Symbol	Parameter	Conditions	Min	Typ	Max	Units
ANALOG INPUTS						
V_{IN}	Analog Diff Input Voltage Range			2.048		V_{PP}
R_{IN} (SE)	Analog Input Resistance (Single-Ended)			500		Ω
R_{IN} (Diff)	Analog Input Resistance (Differential)			1000		Ω
C_{IN}	Analog Input Capacitance			2		pF
ENCODE INPUTS						
V_{IH}	Logic Input High Voltage (Note 5)				4.5	V
V_{IL}	Logic Input Low Voltage (Note 5)		3.0			V
	Differential Input Swing (Note 5)		1.0			V
DIGITAL OUTPUTS						
V_{OL}	Logic Output Low Voltage (Note 2)				0.4	V
V_{OH}	Logic Output High Voltage (Note 2)		2.4			V
TIMING (Note 6)						
	Maximum Conversion Rate (ENCODE) (Note 2) (Note 3)		52	65		MSPS
	Minimum Conversion Rate (ENCODE)			10		MSPS
t_P	Pulse Width High (ENCODE) (Note 5)	50% threshold	9.5			ns
t_M	Pulse Width Low (ENCODE) (Note 5)	50% threshold	9.5			ns
t_{DINV}	ENCODE falling edge to DATA not valid (Note 5)		7.0			ns
t_{DGV}	ENCODE falling edge to DATA guaranteed valid (Note 5)				13.0	ns
	Pipeline delay				3.0	clk cycle
POWER REQUIREMENTS						
I_{CC}	Total Operating Supply Current (Note 2) (Note 3)			123	150	mA
	Power Consumption (Note 2) (Note 3)			615	750	mW
	Power Supply Rejection Ratio			64		dB

Note 1: "Absolute Maximum Ratings" are limiting values, to be applied individually, and beyond which the serviceability of the circuit may be impaired. Functional operability under any of these conditions is not necessarily implied. Exposure to maximum ratings for extended periods may affect device reliability.

Note 2: These parameters are 100% tested at 25°C.

Note 3: These parameters are sample tested at full temperature range.

Note 4: Typical specifications are based on the mean test values of deliverable converters from the first three diffusion lots.

Note 5: Values guaranteed based on characterization and simulation.

Note 6: $C_L = 7pF$ DATA; 10pF DAV.

Note 7: The absolute maximum junction (T_{Jmax}) temperature for this device is 175°C. The maximum allowable power dissipation is dictated by T_{Jmax} , the junction-to-ambient thermal resistance (θ_{JA}), and the ambient temperature (T_A), and can be calculated using the formula $P_{Dmax} = (T_{Jmax} - T_A)/\theta_{JA}$. For the 48-pin TSSOP, θ_{JA} is 56°C/W, so $P_{Dmax} = 2.68W$ at 25°C and 1.6W at the maximum operating ambient temperature of 85°C. Note that the power dissipation of this device under normal operation will typically be about 625 mW (615 mW quiescent power + 10 mW due to 1 TTL load on each digital output). The values of absolute maximum power dissipation will only be reached when the CLC5956 is operated in a severe fault condition (e.g., when input or output pins are driven beyond the power supply voltages, or the power supply polarity is reversed). Obviously, such conditions should always be avoided.

Typical Performance Characteristics (AV_{CC} = DV_{CC} = +5V)

SNR and SFDR vs Input Frequency

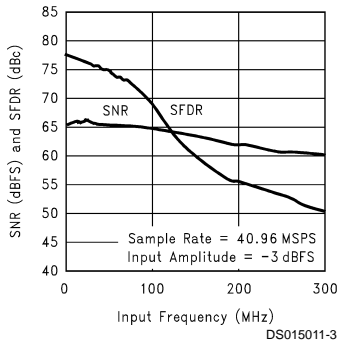

SNR and SFDR vs Input Frequency

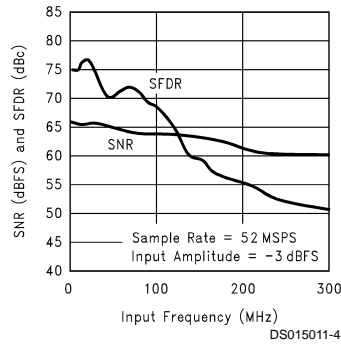

SNR and SFDR vs Input Frequency

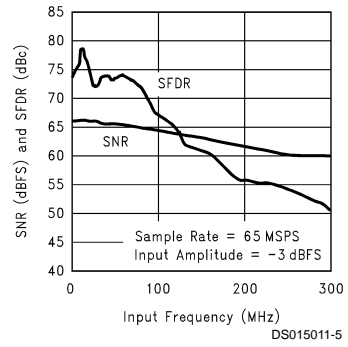

SNR and SFDR vs Sample Rate

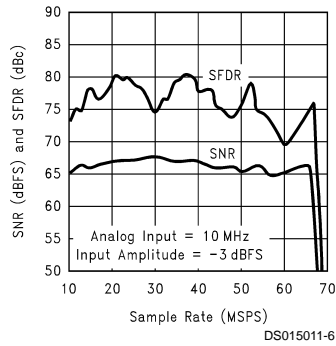

Single Tone Output Spectrum

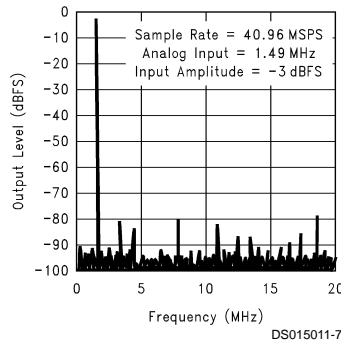

Single Tone Output Spectrum (with Dither)

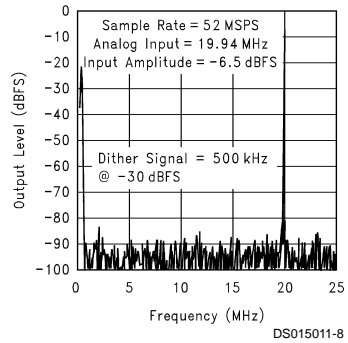

Differential Non-Linearity

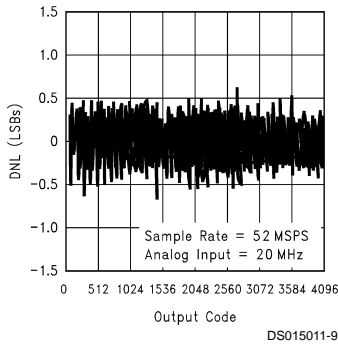

Integral Non-Linearity

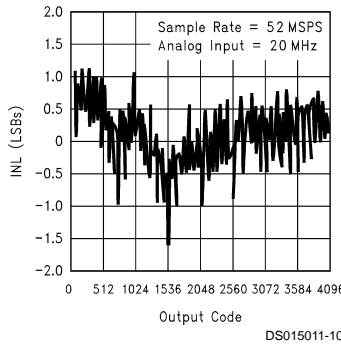

SNR and SFDR vs Input Amplitude

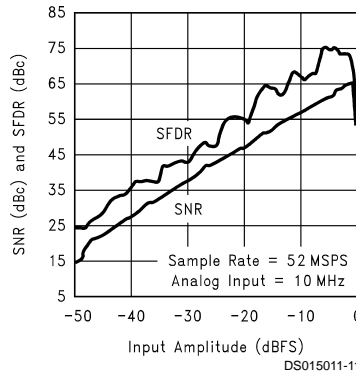

SNR and SFDR vs Input Amplitude

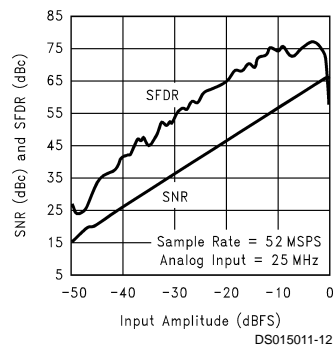

SNR and SFDR vs Input Amplitude

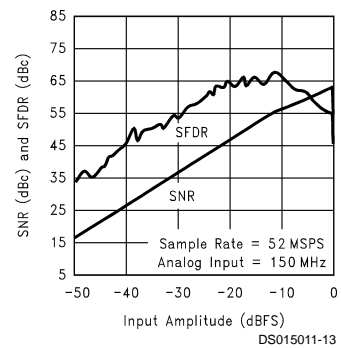

SNR and SFDR vs Input Amplitude

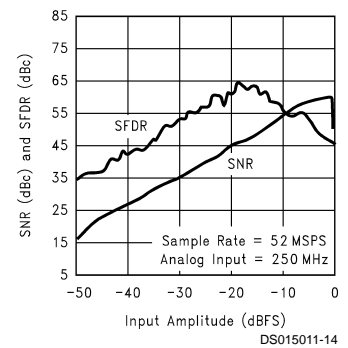

Typical Performance Characteristics $(AV_{CC} = DV_{CC} = +5V)$ (Continued)

Two Tone Output Spectrum (with Dither)

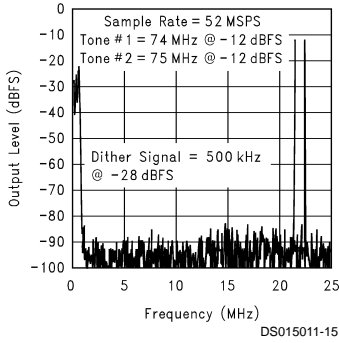

Two Tone Output Spectrum

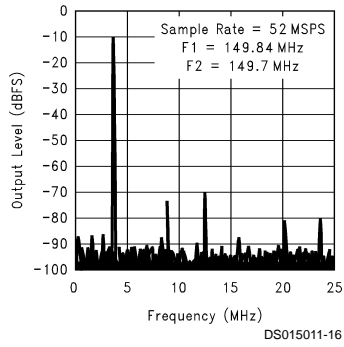

Two Tone Output Spectrum

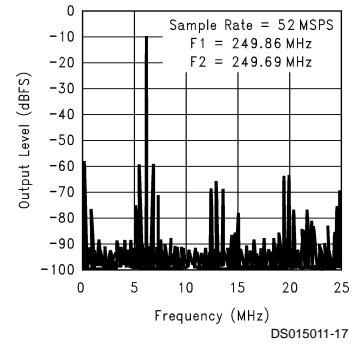

Spectral Response

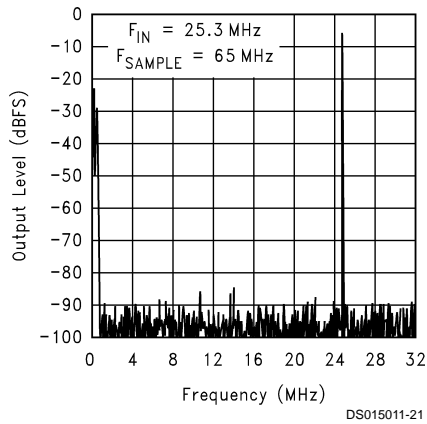

SINAD vs Input Level

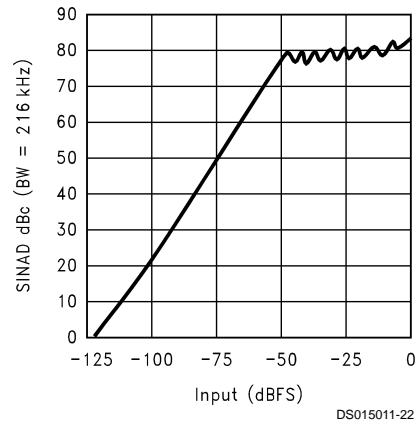

Timing Diagram

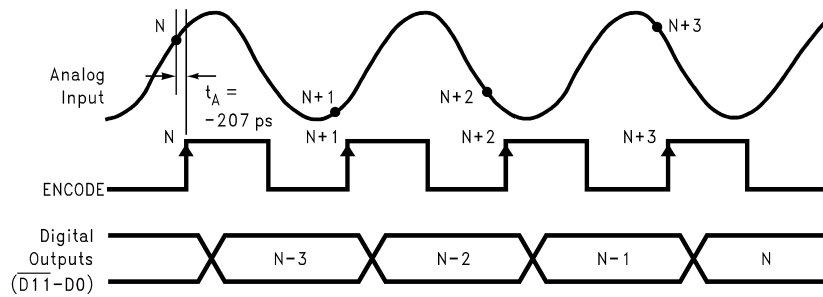

CLC5956 Aperture Delay Diagram

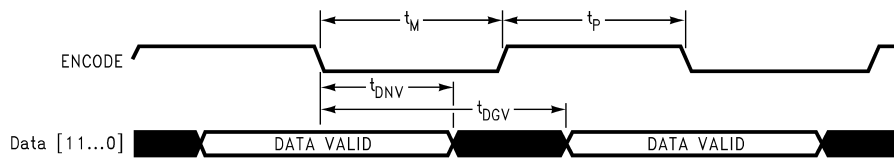

CLC5956 ENCODE to Data Timing Diagram

DS015011-18

Full Scale Analog Input Levels

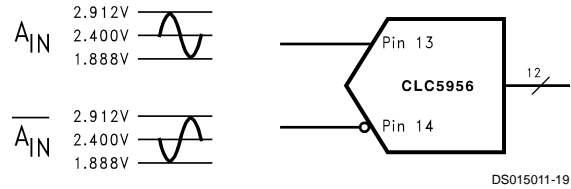

Single IF Down Converter

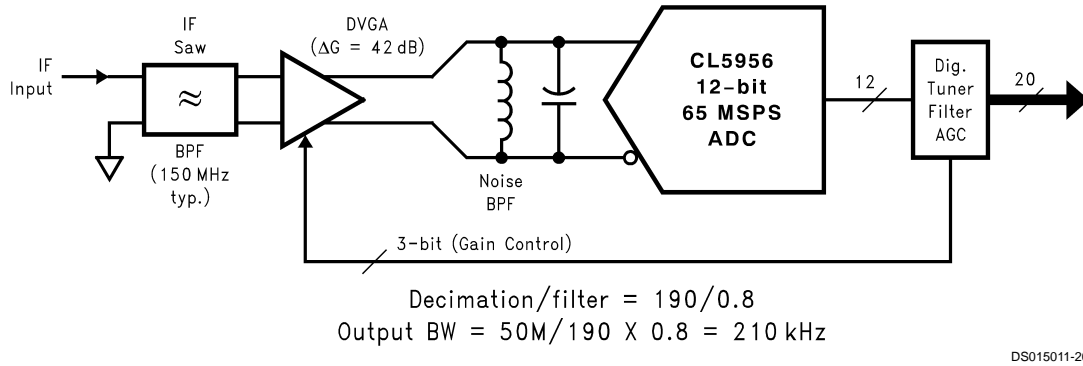

Evaluation Board

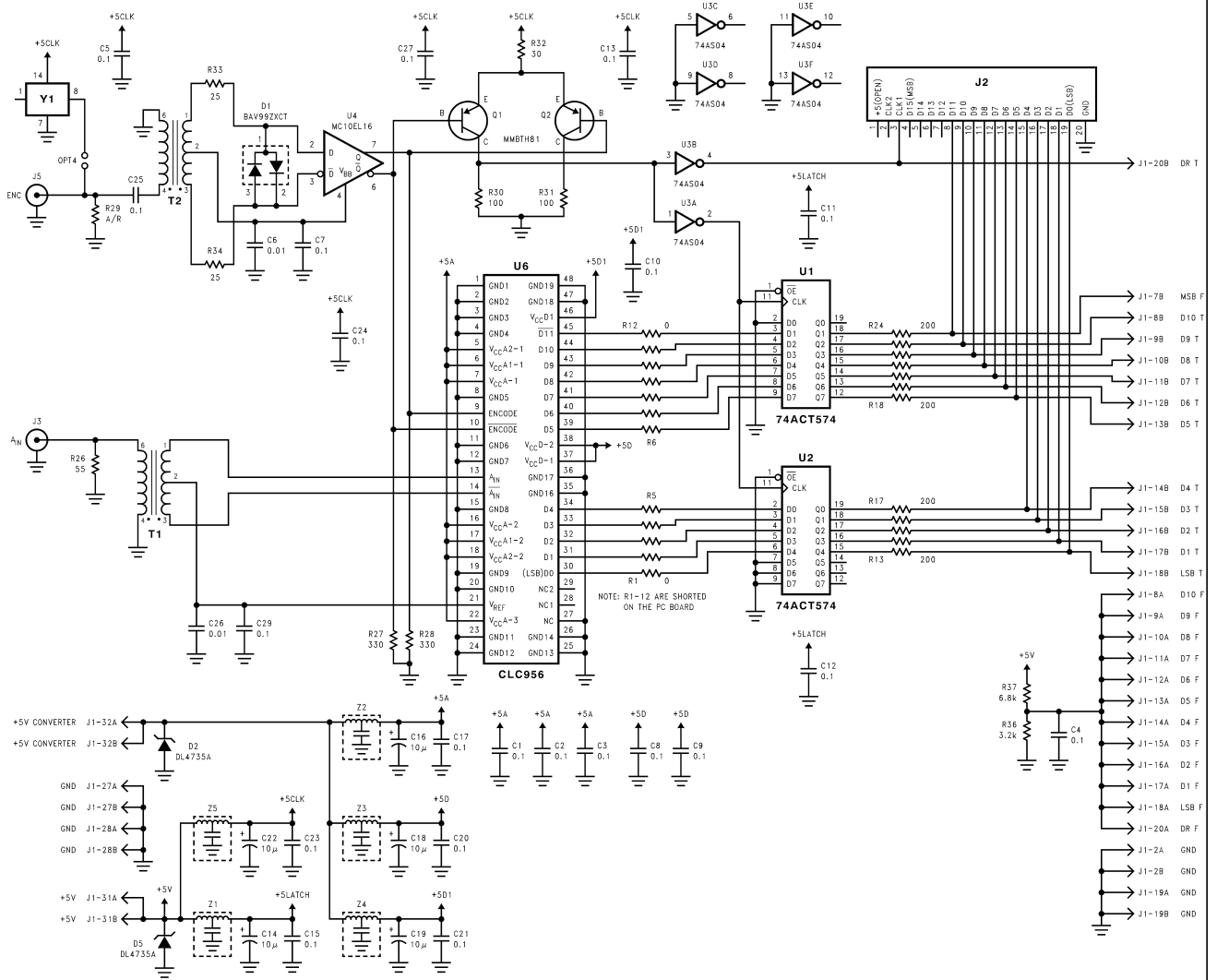

Evaluation Board Schematic

DS015011-23

Evaluation Board (Continued)

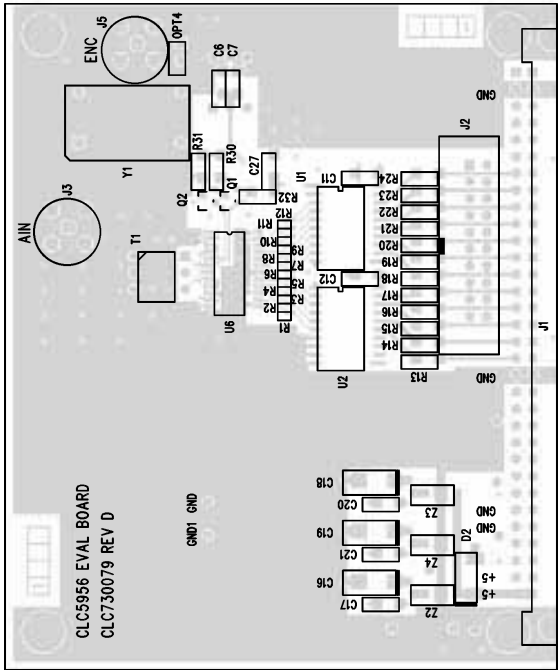

DS015011-24

CLC730079 Layer 1

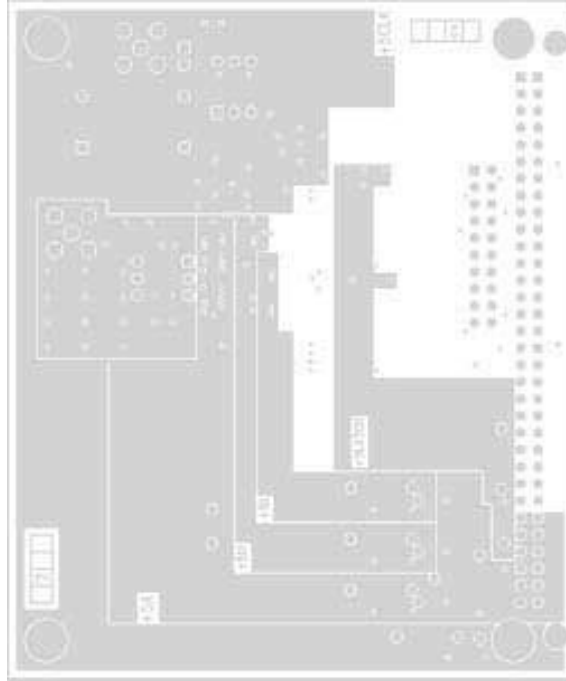

DS015011-26

CLC730079 Layer 2

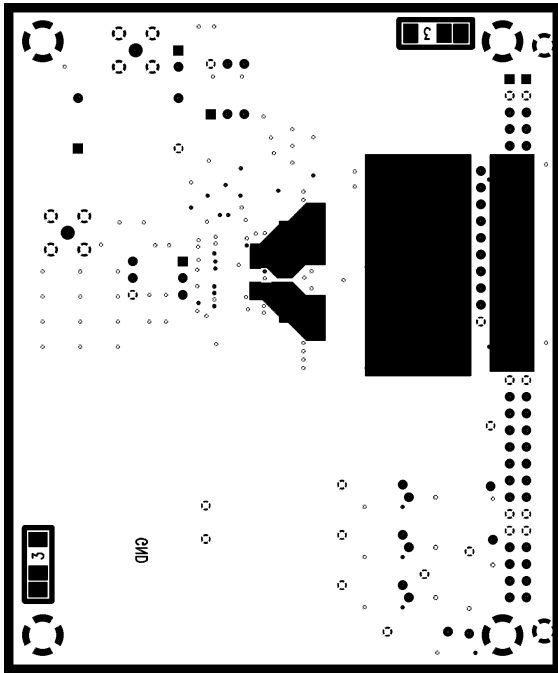

DS015011-25

CLC730079 Layer 3

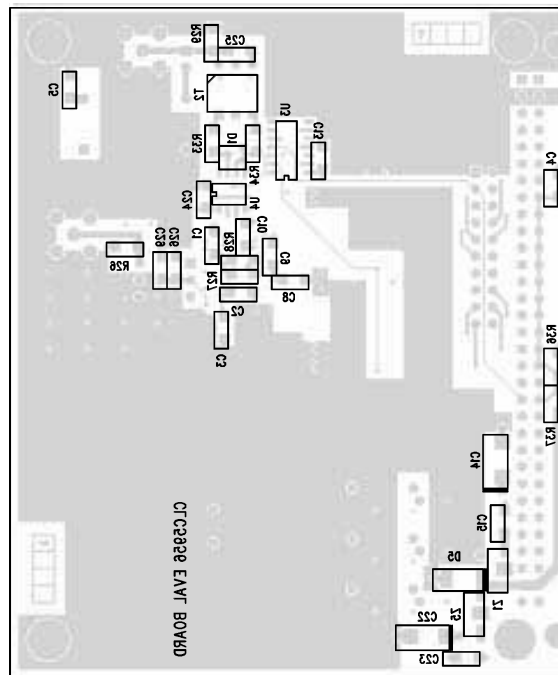

DS015011-27

CLC730079 Layer 4

Evaluation Printed Circuit Board

The Evaluation board for the CLC5956 allows for easy test and evaluation of the product. The part may be ordered with all components loaded and tested. The order number is the CLC5956PCASM. The user supplies an analog input signal, encode signal and power to the board and is able to take latched 12-bit digital data out of the board.

ENCODE Input (ENC)

The ENCODE input is an SMA connector with a 50Ω termination. The signal is converted from single to differential and its **frequency is divided by four** to produce a low jitter, symmetrical encode signal for the CLC5956. The user should provide a sinusoidal or square wave signal of 10 dBm to 16 dBm amplitude at **four times the converter's desired sample rate**. It is recommended that the source be low jitter to maintain best performance. The transformer will pass signals in the 40 MHz to 260 MHz range which allows sample rates of 10 Msps to 65 Msps.

Clock Option

The CLC5956 board is configured for a 4x clock input to provide optimal performance with some (i.e., HP8662) synthesizers. The HP8662 output has lower jitter above 160 MHz. Using a 208 MHz clock to sample at 52 MHz minimizes the effect of the synthesizer on the measurement.

To use a 1x clock, replace the divide-by-4 sine-to-PECL converter (U4, MC10EL33D) with an MC10EL16D. The MC10EL16D sine-to-PECL converter does not divide the clock. This approach would be suitable for use with a synthesizer that has optimal jitter performance at 52 MHz (i.e., HP8643 or HP8644).

The best ADC performance is obtained with a low-jitter crystal oscillator module installed at Y1 on the evaluation board. U4 should be replaced with an MC10EL16D. Placing the clock source on the evaluation board reduces ground loop issues and thus improves performance.

Analog Input (AIN)

The analog input is an SMA connector with a 50Ω termination. The signal is converted from single to differential by a transformer with a 5 MHz to 260 MHz bandwidth and approximately one dB loss. Full scale is approximately 11 dBm or 2.2 V_{PP}. It is recommended that the source for the analog input signal be low jitter, low noise and low distortion to allow for proper test and evaluation of the CLC5956.

Supply Voltages (J1 pins 31 A&B and 32 A&B)

The CLC5956PCASM is powered from a single 5V supply connected from the referenced pins on the Eurocard connector. The recommended supplies are low noise linear supplies.

Digital Outputs (J1 pins 7A ($\overline{\text{MSB}}$, D11), 8B (D10) through 18B (LSB) and 20B (Data Ready))

The digital outputs are provided on the Eurocard connector. The outputs are buffered by 5V CMOS latches with 50Ω series output resistors. The rising edge of Data Ready may be used to clock the output data into data collection cards or

logic analyzers. The board has a location for the HP 01650-63203 termination adapter for HP 16500 logic analyzers to simplify connection to the analyzer.

Minimum Conversion Rate

This ADC is optimized for high-speed operation. The internal bipolar track and hold circuits will cause droop errors at low sample rates. The point at which these errors cause a degradation of performance is listed on the specifications page as the minimum conversion rate. If a lower sample rate is desired, the ADC should be clocked at a higher rate, and the output data should be decimated. For example, to obtain a 10MSPS output, the ADC should be clocked at 20MHz, and every other output sample should be used. No significant power saving occurs at lower sample rates, since most of the power is used in analog circuits rather than digital circuits.

CLC5957 and CLC5956 Interchangeability

The CLC5957 and CLC5956 12-bit, A/D converters are interchangeable in applications when certain pinout requirements are met. It is important to note that the CLC5957 offers the following performance enhancements that are not included in the CLC5956:

- Increased guaranteed sample rate over temperature to 70MHz
- An internal PECL converter for the clock input so a wide range of AC-coupled differential signals can be used
- A data valid output clock (DAV) to simplify the output interface
- The means to place the part in a shut-down state to reduce power dissipation

Due to these enhancements, some of the pin functions of the CLC5957 and CLC5956 are different. *Table 1* describes these pin differences for each of the devices. Since the CLC5957 and CLC5956 have the same package footprint, the CLC5957 can be dropped in place of a CLC5956 if certain pin connections are made. If full functionality of the CLC5957 is desired when replacing the CLC5956, the board layout for the CLC5956 will need to be modified with the connections described in the 'CLC5957' column of *Table 1*. If only CLC5956 functionality is to be retained when replacing a CLC5956 with a CLC5957, then the board layout for the CLC5956 should be modified with the connections described in the 'Option' column of *Table 1*.

CLC5957 and CLC5956 Interchangeability (Continued)**TABLE 1. CLC5957 and CLC5956 Pin Compatibility**

Pin No.	CLC5956	CLC5957	Option
Pin 21	V_{CM}^*	V_{CM}^*	V_{CM}^*
Pin 27	NC	DAV	Open
Pin 28	NC	OUTLEV	Open
Pin 29	NC	NC	Open

*Pin 21 (V_{CM}) should be buffered as described in the CLC5956 and CLC5957 datasheet pin definitions. Failure to buffer this signal can cause errors in the internal bias currents.

Physical Dimensions inches (millimeters) unless otherwise noted

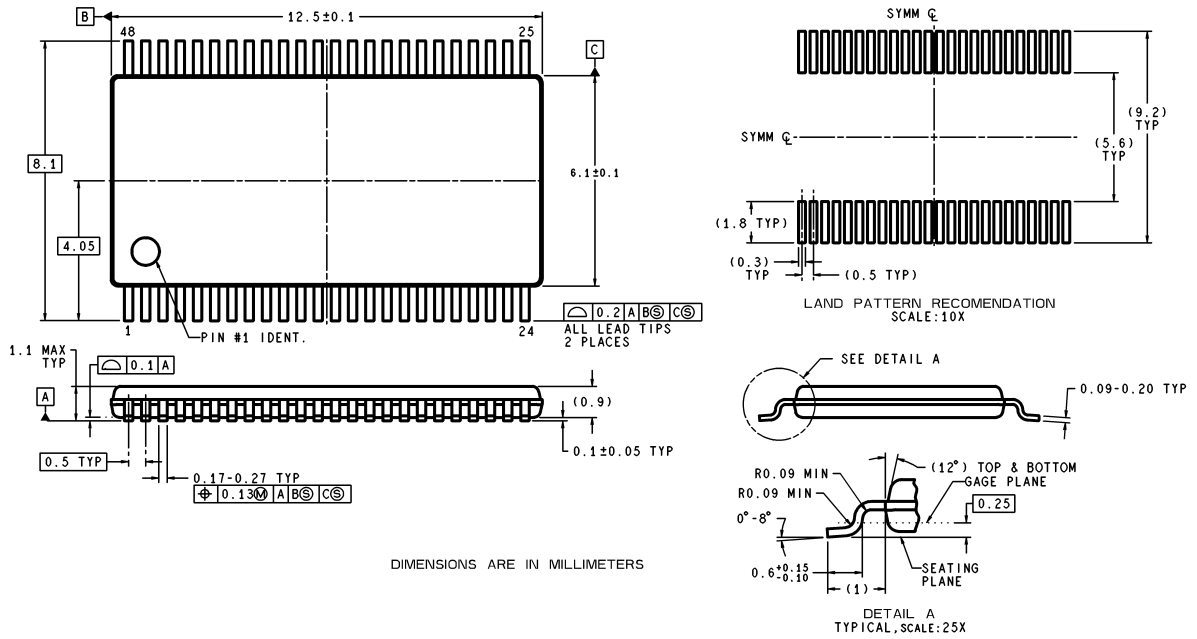

MTD48 (Rev. C)

48-Lead TSSOP (Millimeters Only)
Order Number CLC5956IMTD
NS Package Number MTD48

LIFE SUPPORT POLICY

NATIONAL'S PRODUCTS ARE NOT AUTHORIZED FOR USE AS CRITICAL COMPONENTS IN LIFE SUPPORT DEVICES OR SYSTEMS WITHOUT THE EXPRESS WRITTEN APPROVAL OF THE PRESIDENT AND GENERAL COUNSEL OF NATIONAL SEMICONDUCTOR CORPORATION. As used herein:

1. Life support devices or systems are devices or systems which, (a) are intended for surgical implant into the body, or (b) support or sustain life, and whose failure to perform when properly used in accordance with instructions for use provided in the labeling, can be reasonably expected to result in a significant injury to the user.
2. A critical component is any component of a life support device or system whose failure to perform can be reasonably expected to cause the failure of the life support device or system, or to affect its safety or effectiveness.



National Semiconductor Corporation
Americas
Tel: 1-800-272-9959
Fax: 1-800-737-7018
Email: support@nsc.com
www.national.com

National Semiconductor Europe
Fax: +49 (0) 180-530 85 86
Email: europe.support@nsc.com
Deutsch Tel: +49 (0) 69 9508 6208
English Tel: +44 (0) 870 24 0 2171
Français Tel: +33 (0) 1 41 91 8790

National Semiconductor Asia Pacific Customer Response Group
Tel: 65-2544466
Fax: 65-2504466
Email: ap.support@nsc.com

National Semiconductor Japan Ltd.
Tel: 81-3-5639-7560
Fax: 81-3-5639-7507